

M. NEPPER IBOLYA

HAJDÚ-BIHAR MEGYE 10–11. SZÁZADI SÍRLELETEI

2. RÉSZ



BUDAPEST-DEBRECEN
2002

MAGYARORSZÁG HONFOGLALÁS KORI ÉS KORA ÁRPÁD-KORI SÍRLELETEI 3.

Sorozatszerkesztő:
Kovács László és Révész László

ISBN 963 9046 79 5ö

1. rész: 963 9046 80 9

2. rész: 963 9046 81 7

ISSN 1219 79 71



10.62150/HONF.3.2.2002

Szerkesztő:

K. BENDE ILDIKÓ

Technikai szerkesztés:

PAULUS BT

Lektorálta:

KOVÁCS LÁSZLÓ és RÉVÉSZ LÁSZLÓ

Tárgy- és rekonstrukciós rajzok:

DÉKÁNY ÁGOSTON

Sírrajzok:

CSUTAK TÜNDE, DANI JÁNOS, MÓDI ZSUZSA, M. NEPPER IBOLYA és SZABÓ LÁSZLÓ

Fotók:

KÁDAS TIBOR és RÁK REZSŐ

Borítóterv:

PAULUS BT

A borítón:

Sárrétudvari-Hízóföld 118. sír, gyöngysor
Hajdúszoboszló-Árkoshalom 248. sír és Sárrétudvari-Poroshalom 1. sír, ijcsontok
Sárrétudvari-Hízóföld 115. sír, csüngő

Fotó:

HAPÁK JÓZSEF

M. NEPPER IBOLYA

HAJDÚ-BIHAR MEGYE 10–11. SZÁZADI SÍRLELETEI

2. rész

Kiadó

a DSI Műhely

a Magyar Nemzeti Múzeum

a Magyar Tudományos Akadémia Régészeti Intézete

a Nemzeti Köznevelési Központ Kiadóval

az OTKA-T 02380

és a Szentgyörgyi István Alap támogatásával

szépirodalom

© M. Nepper Ibolya, 2002

ISBN 963 13 1052 2
A kiadvány elkészítését a Magyar Nemzeti Múzeum 2002. évi költségvetésében támogatja.
A kiadvány elkészítését a Magyar Nemzeti Múzeum 2002. évi költségvetésében támogatja.

Budapest – Debrecen

2002

A kötet
a Déri Múzeum, a Magyar Nemzeti Múzeum
és a Magyar Tudományos Akadémia Régészeti Intézete
közös kiadványa

Készült
a Déri Múzeum,
a Magyar Nemzeti Múzeum,
a Magyar Tudományos Akadémia Régészeti Intézete,
a Nemzeti Kulturális Örökség Minisztériuma,
az OTKA T 030090,
és a Széchenyi Terv 5./081. számú pályázatának
anyagi támogatásával

© M. Nepper Ibolya, 2002
© Déri Múzeum, 2002. Igazgató: Szatmári Ibolya
Magyar Nemzeti Múzeum, 2002. Főigazgató: Kovács Tibor
MTA Régészeti Intézete, 2002. Igazgató: Bálint Csanád

Nyomás és kötészet: Kurucz Gábor
1025 Budapest, Vöröstorony lejtő 5.

TARTALOM

Berekböszörmény-Református templom	1. tábla
Biharkesztes-Bethlen Gábor utca 25	2-7. tábla
Debrecen-Clara Zetkin utca 9.	8-9. tábla
Debrecen-Józsa, Klastrompart	10. tábla
Derecske-Dr. Balogh János tanyája	11. tábla
Nagyrabé-Des Echerolles dűlő	11. tábla
Ebes-Templomdűlő	12. tábla
Hajdúböszörmény-Bodaszőlő, Búdöskút	13-24. tábla
Hajdúszoboszló-Árkoshalom	25-112. tábla
Hajdúszoboszló-Bercsényi utca 49.	113. tábla
Körösszegapáti-Pállapály	114-125. tábla
Püspökladány-Eperjesvölgy	126-222. tábla
Sárrétudvari-Hízó föld	223-340. tábla
Sárrétudvari-Órhalom	341-343. tábla
Sárrétudvari-Poroshalom	344-364. tábla
Ismeretlen lelőhely (Báránd belterület)	365-367. tábla

*

Állatsontleletek	368-377. tábla
Érmecleletek	378-384. tábla

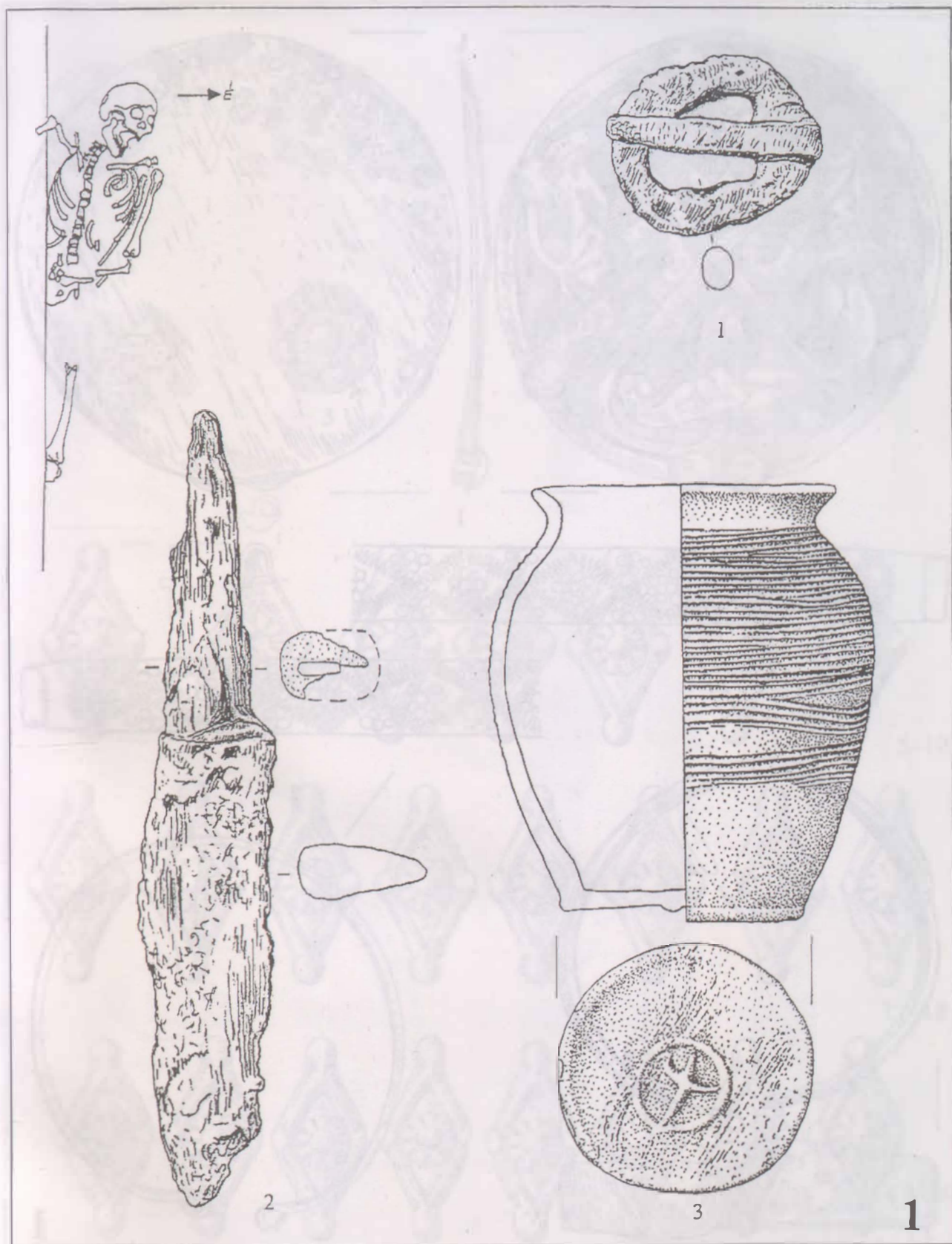

1. tábla: Berekböszörmény-Református templom. 1. sír (1-2. 1:1; 3. 1:2)

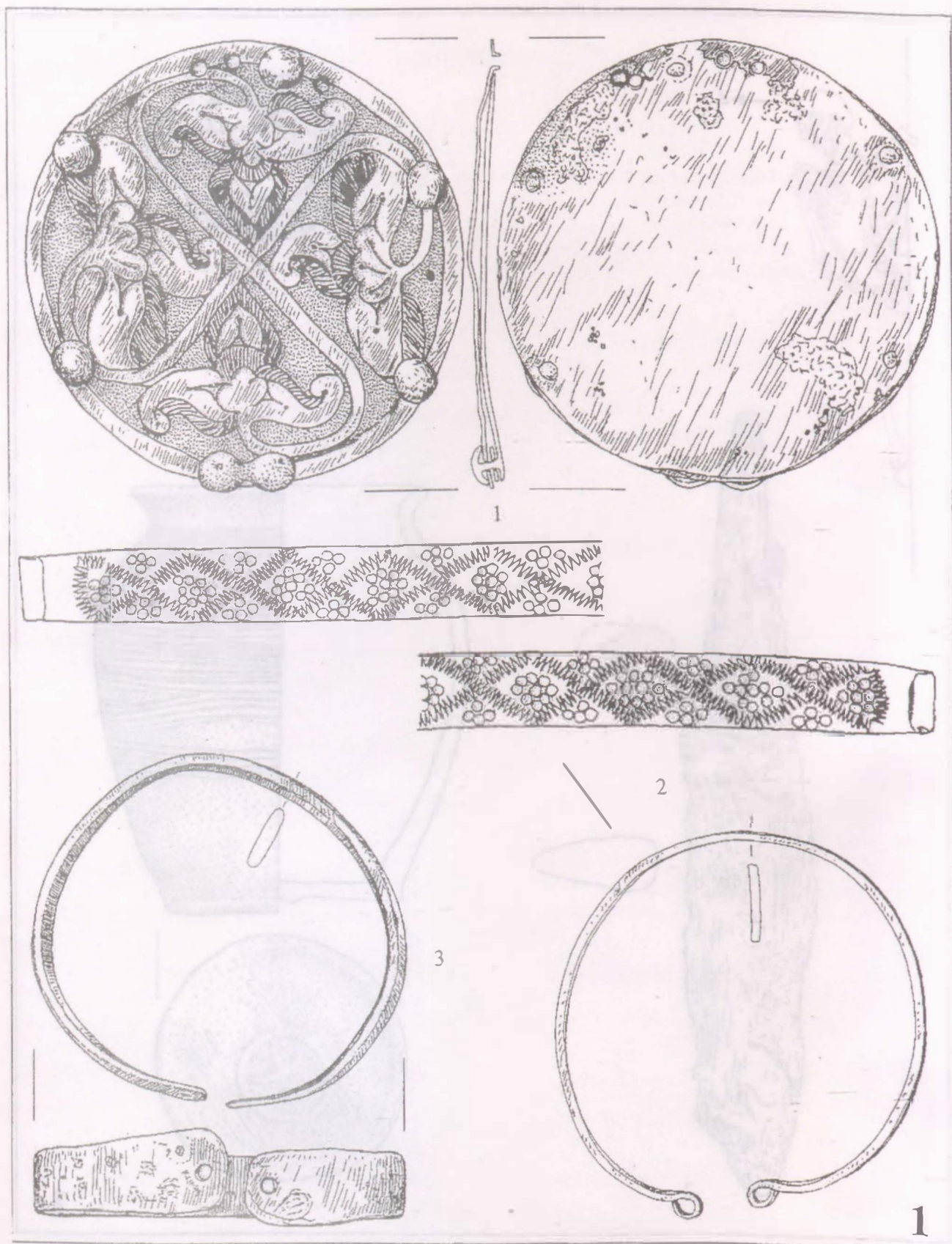

2. tábla: Biharkeresztes-Bethlen Gábor utca 25. 1. sír (1:1)

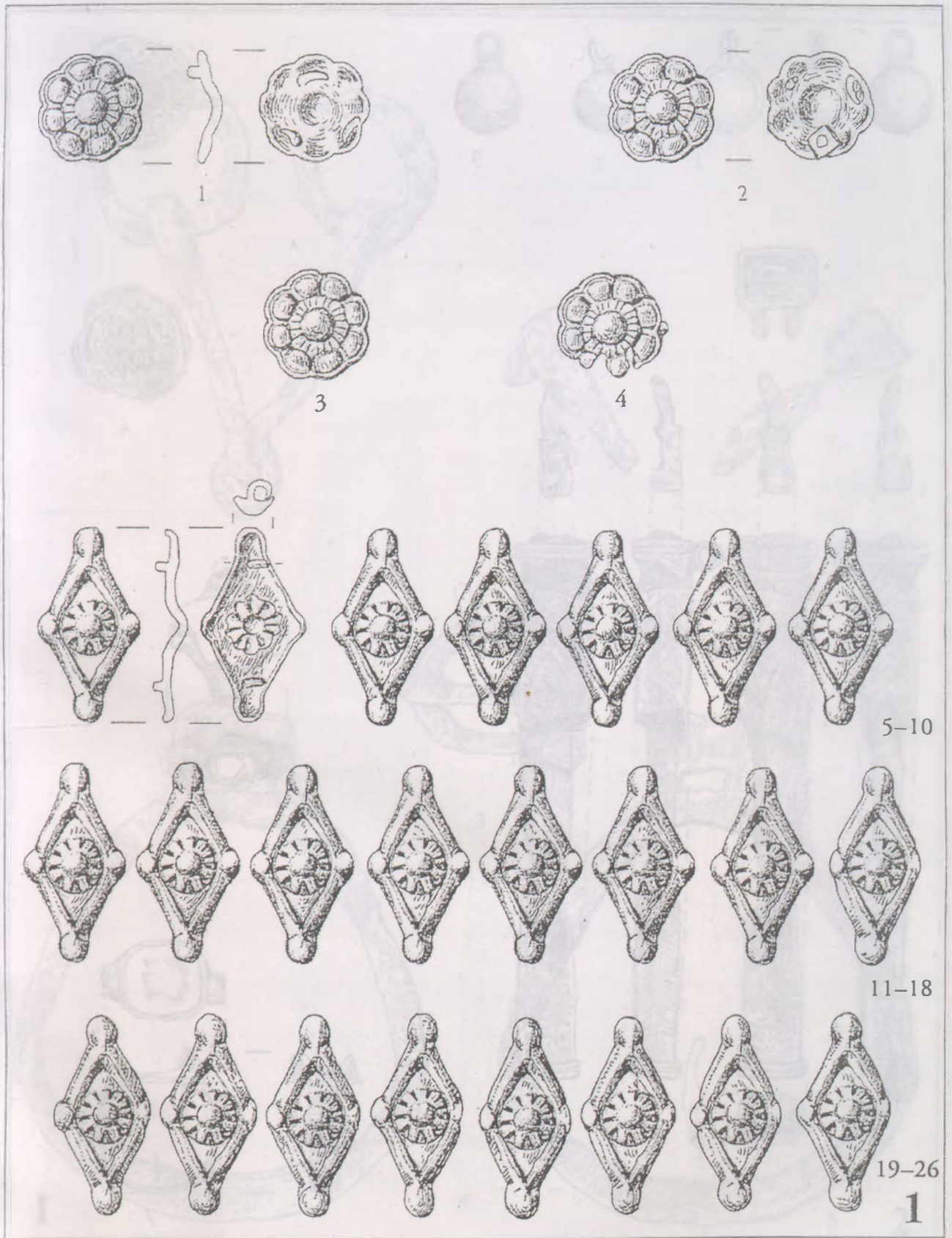

3. tábla: Biharkeresztes-Bethlen Gábor utca 25. 1. sír (1:1)

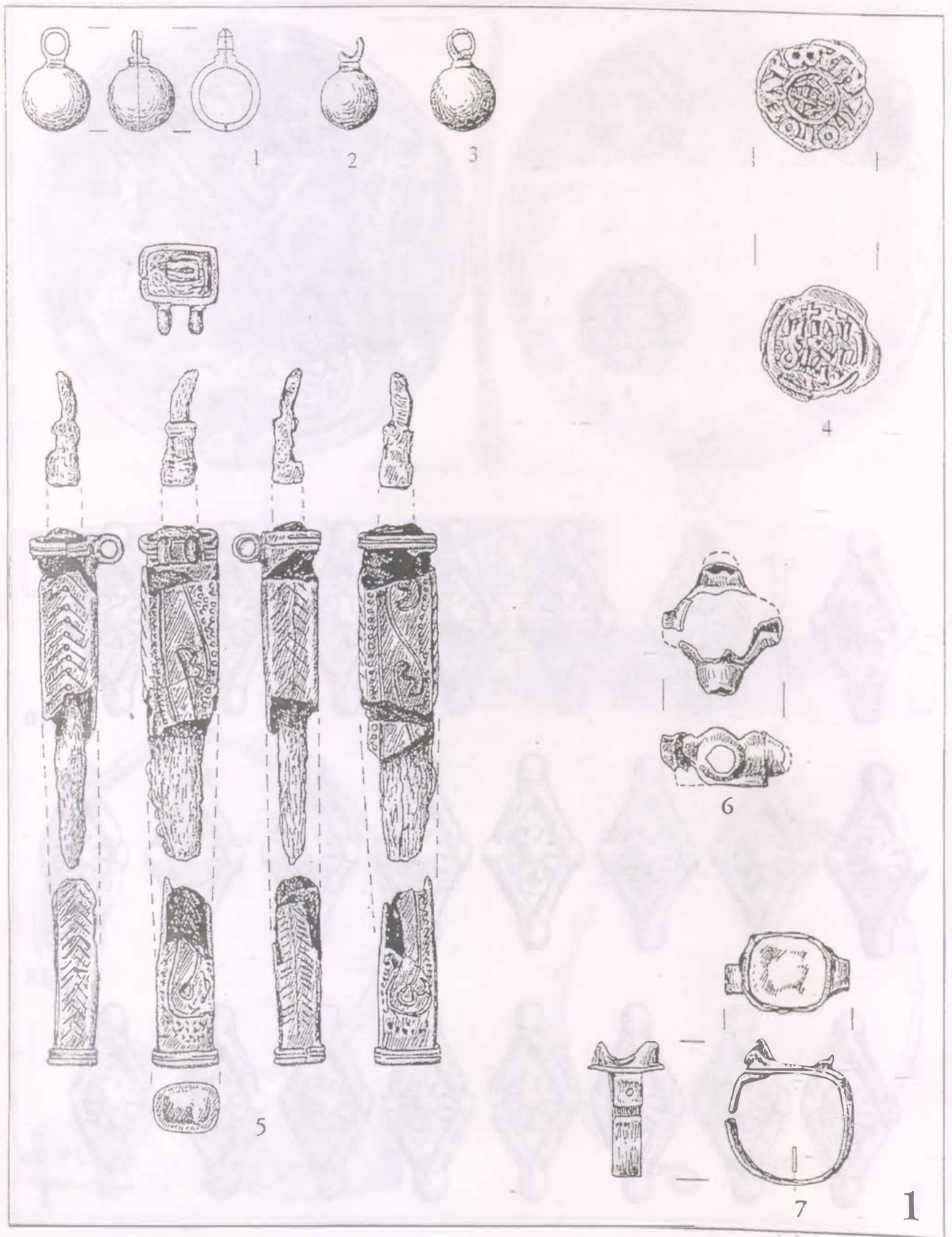

4. tábla: Biharkeresztes-Bethlen Gábor utca 25. 1. sír (1:1)

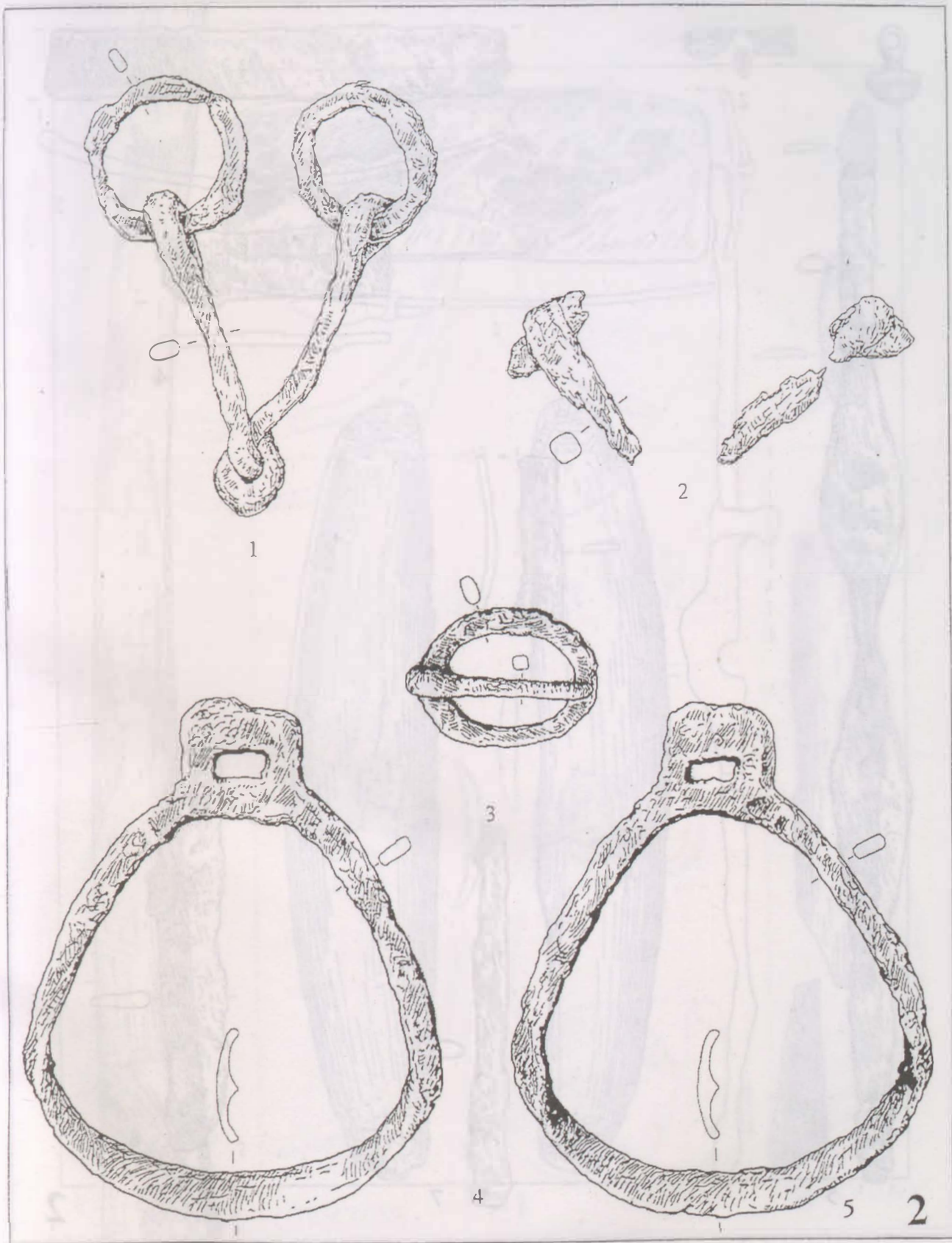

5. tábla: Biharkeresztes-Bethlen Gábor utca 25. 2. sír (1:2)

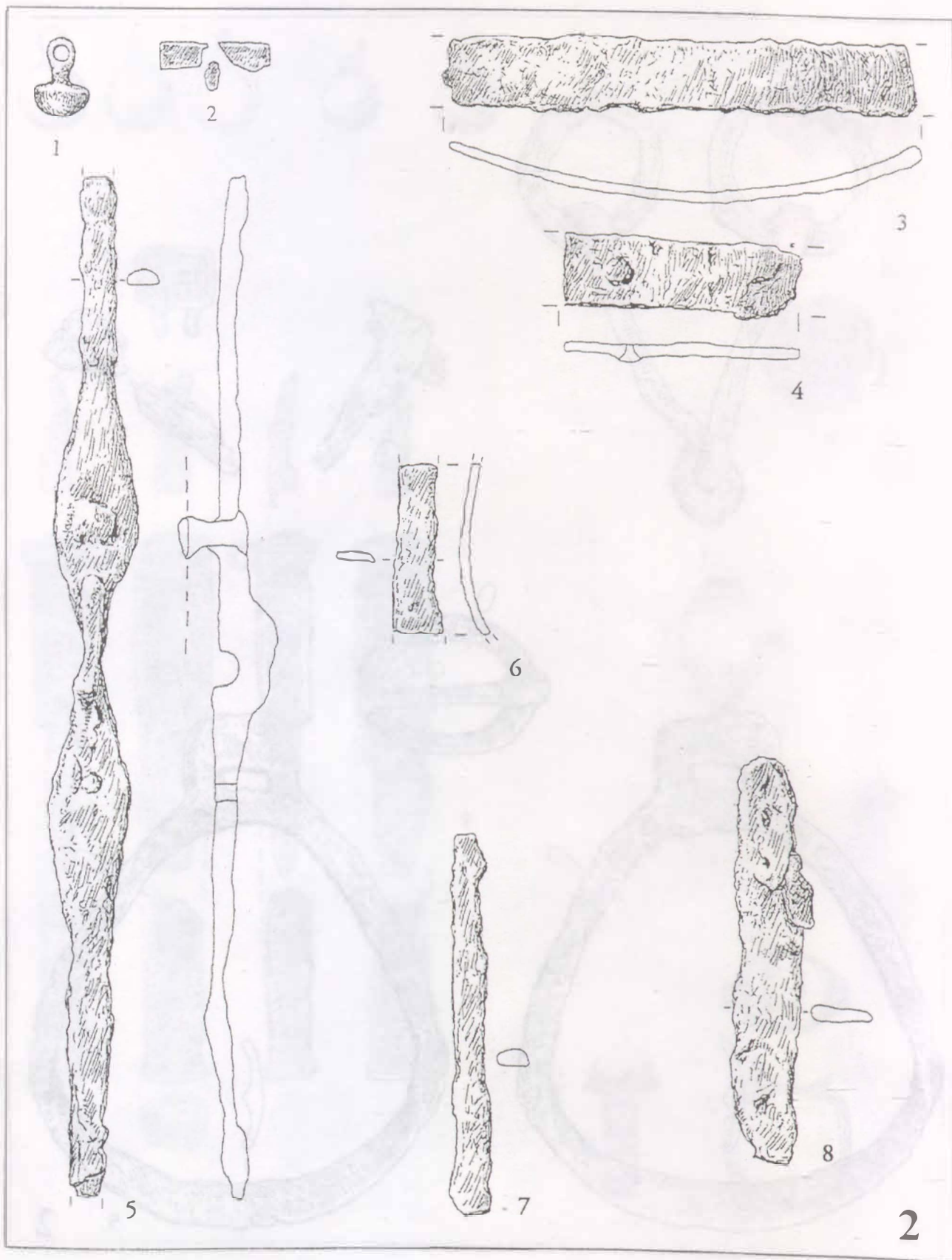

6. tábla: Biharkeresztes-Bethlen Gábor utca 25. 2. sír (1:1)

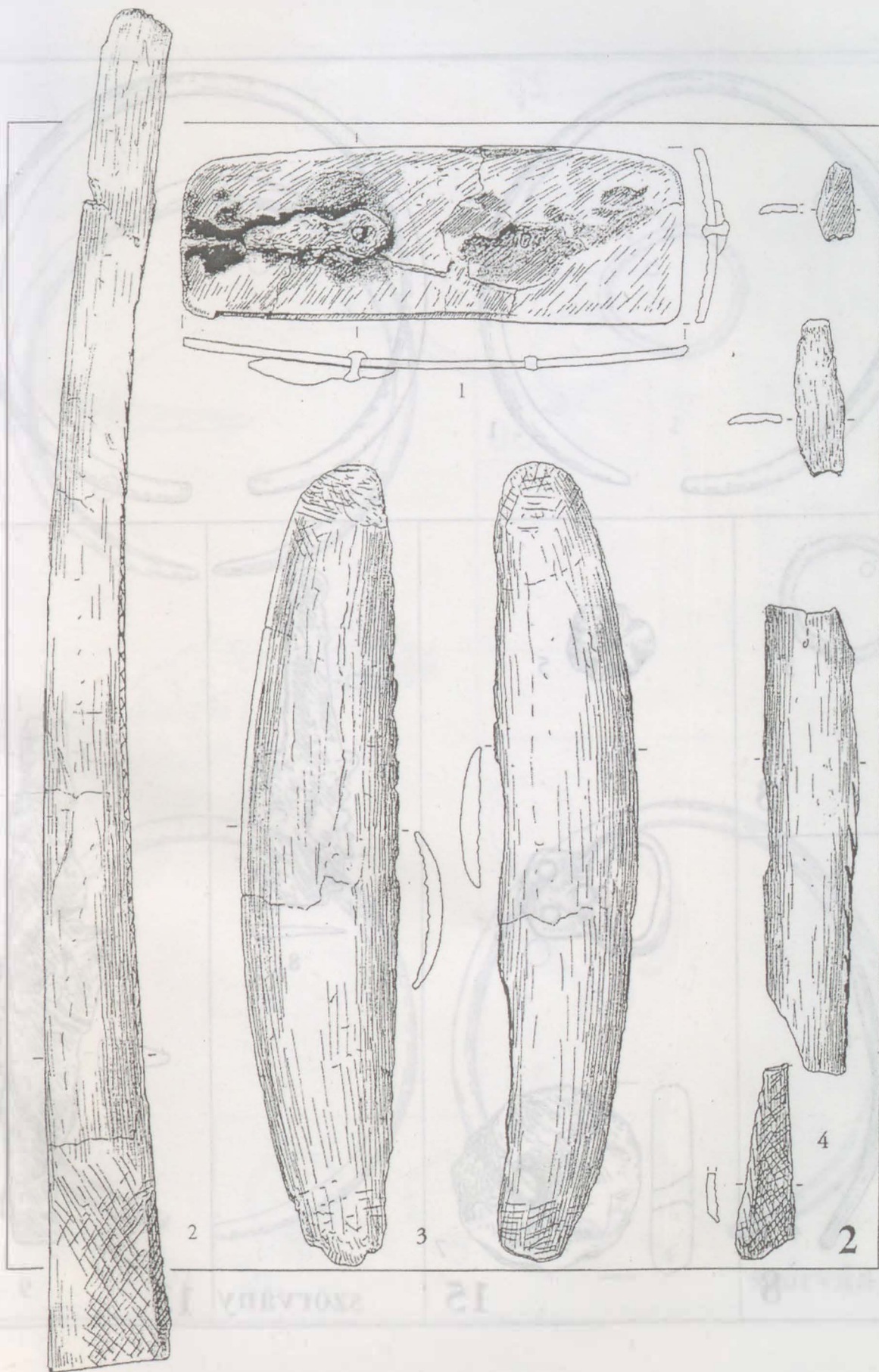

7. tábla: Biharkeresztes-Bethlen Gábor utca 25. 2. sír (1:1)

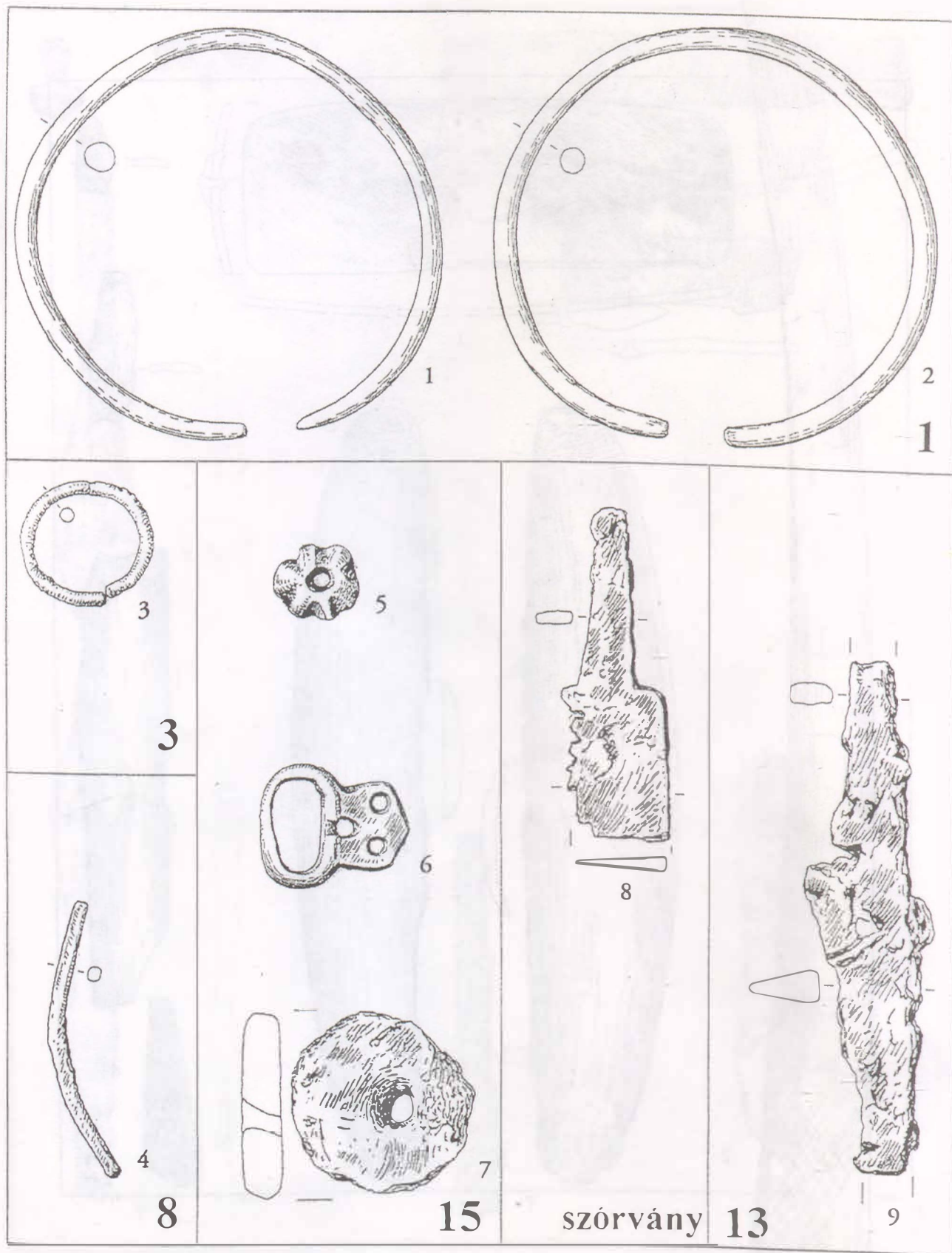

8. tábla: Debrecen-Józsa, Clara Zetkin utca. 1., 3., 8., 13., 15. sír és szórvány (1:1)

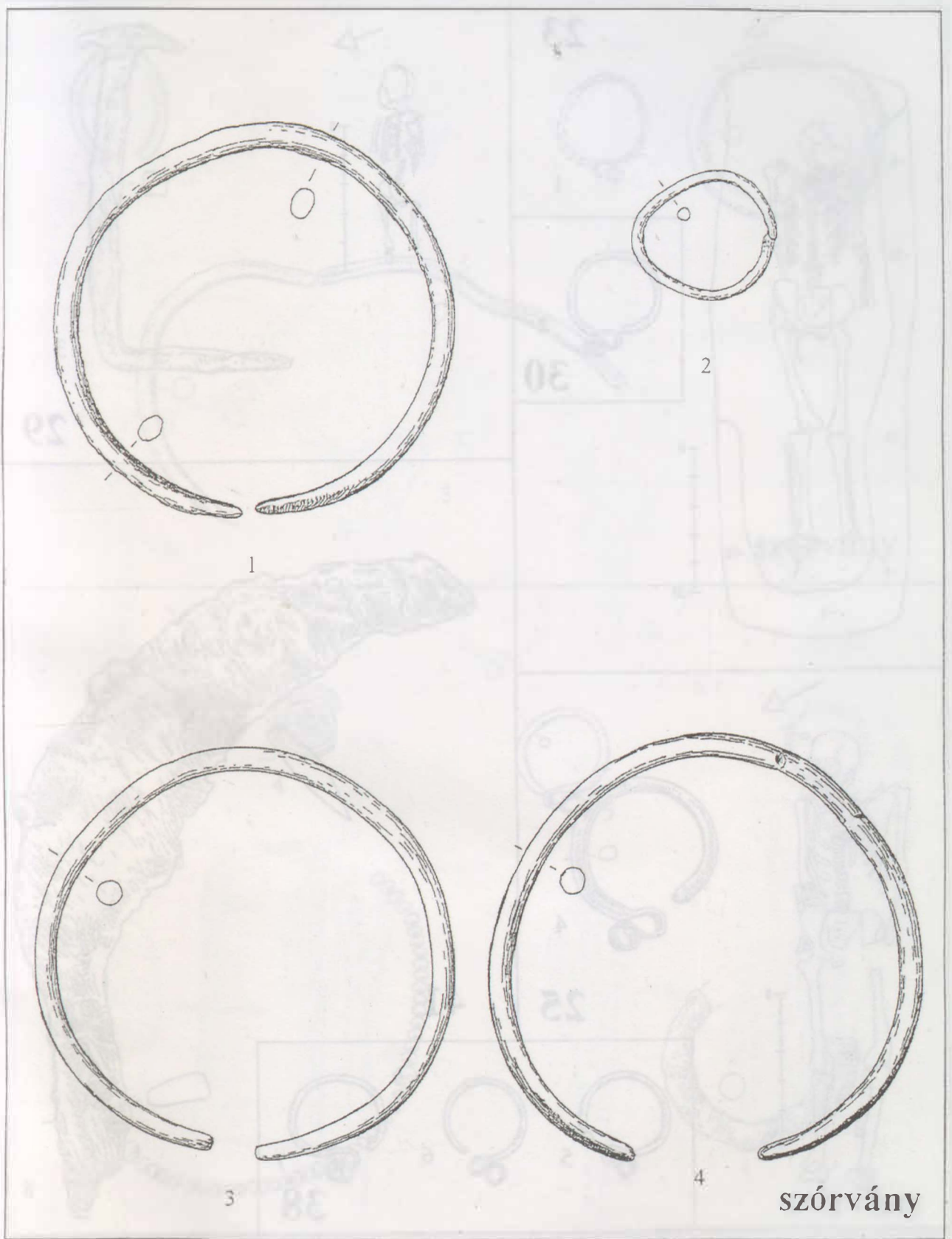

9. tábla: Debrecen-Józsa, Clara Zetkin utca. Szórvány (1:1)

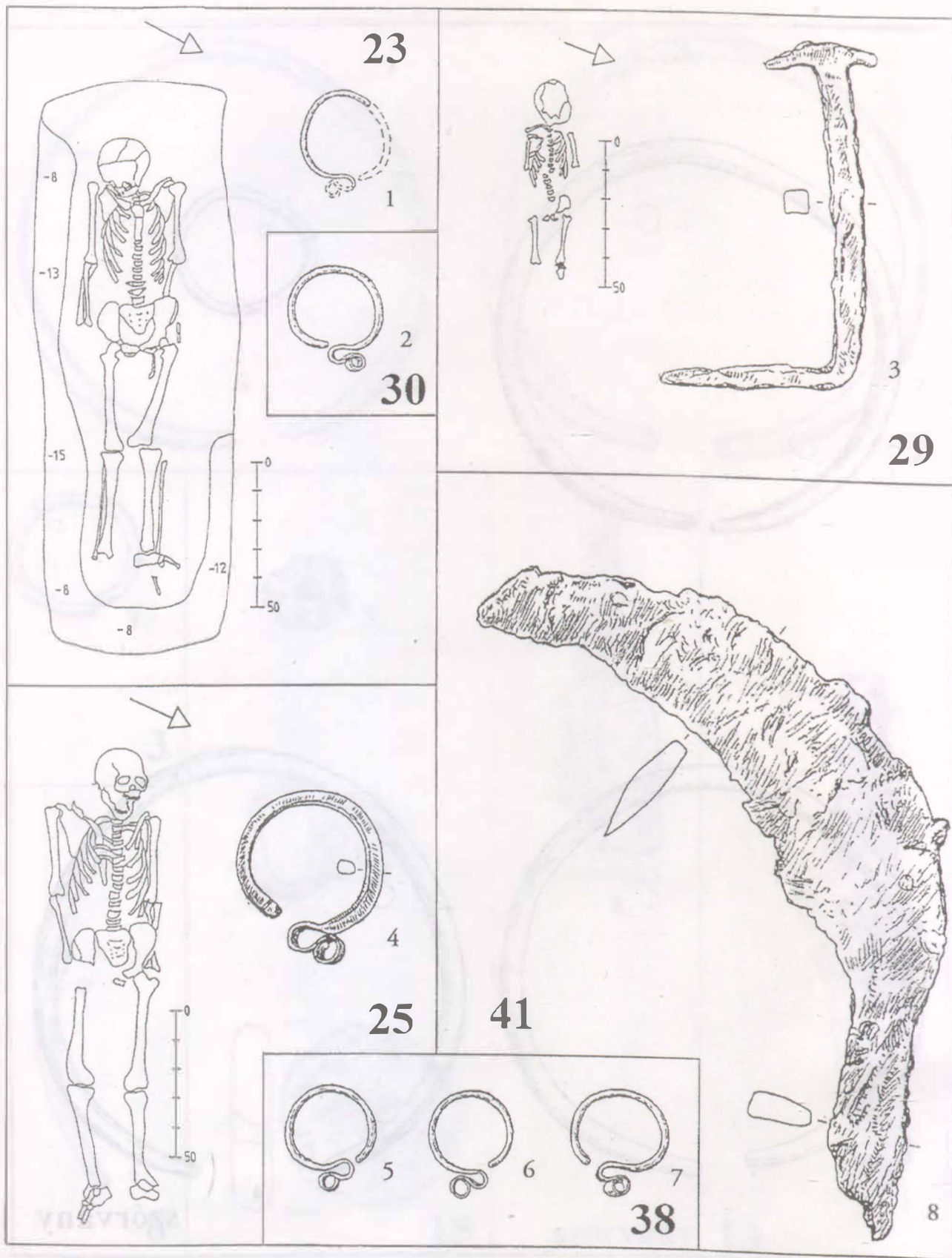

10. tábla: Debrecen-Józsa, Klastrompart. 23., 25., 29., 30., 38., 41. sír (1:1)

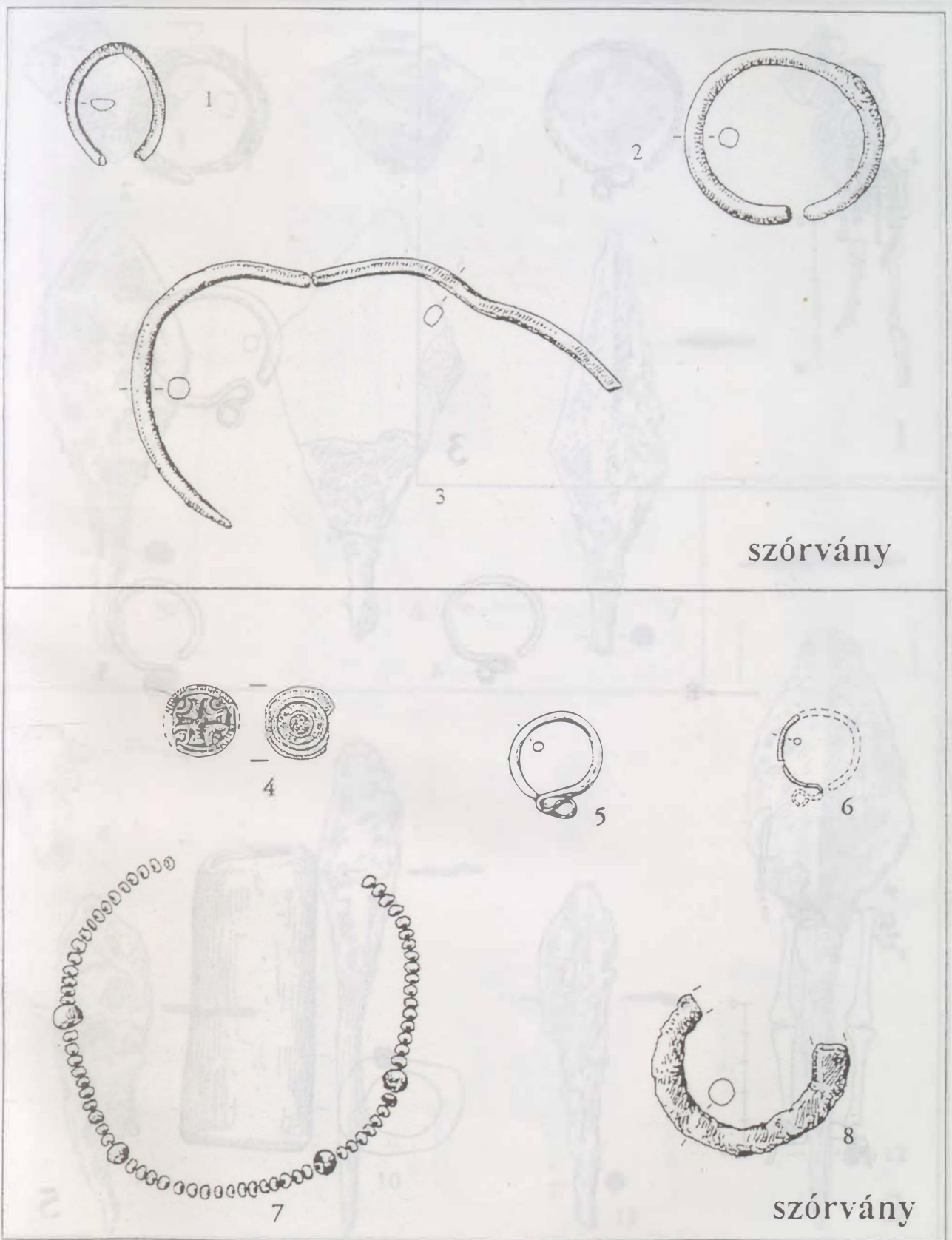

11. tábla: Derecske-dr. Balogh János tanyája. Szórvány. Nagyrábé-Des Echerolles-dűlő. Szórvány (1:1)

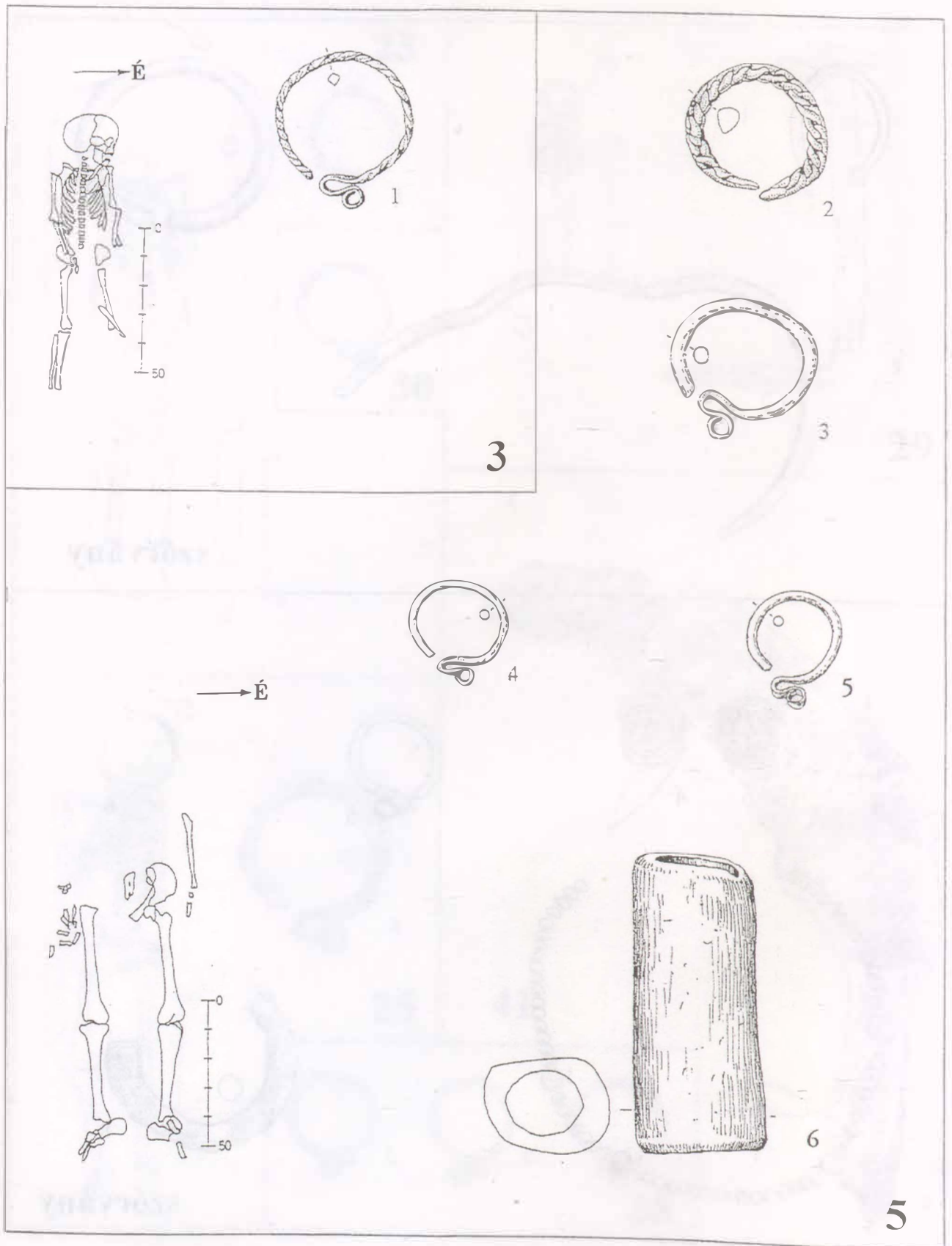

12. tábla: Ebess-Templomdűlő. 3., 5. sír (1:1)

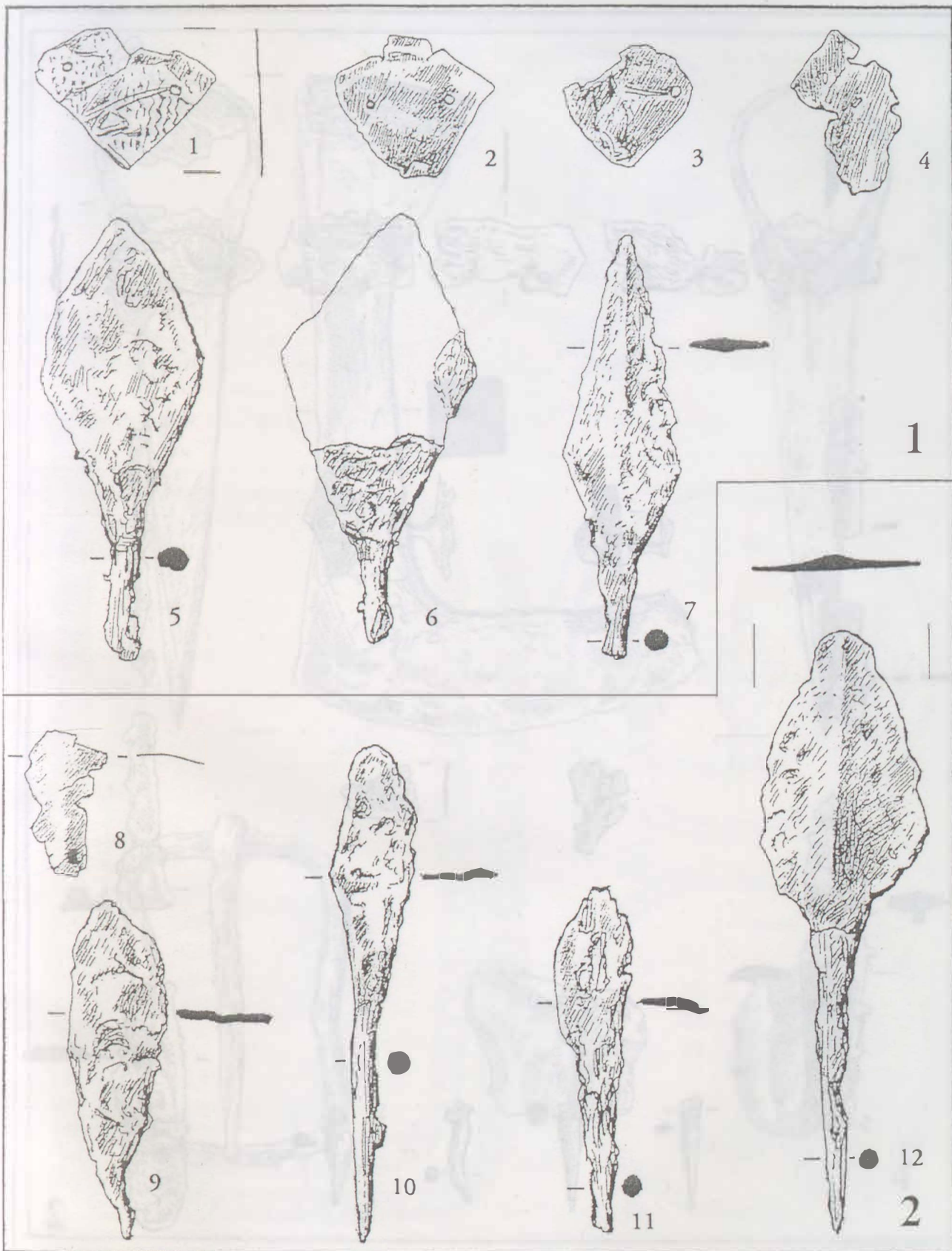

13. tábla: Hajdúböszörmény-Bodaszőlő, Büdöskút. 1., 2. sír (1:1)

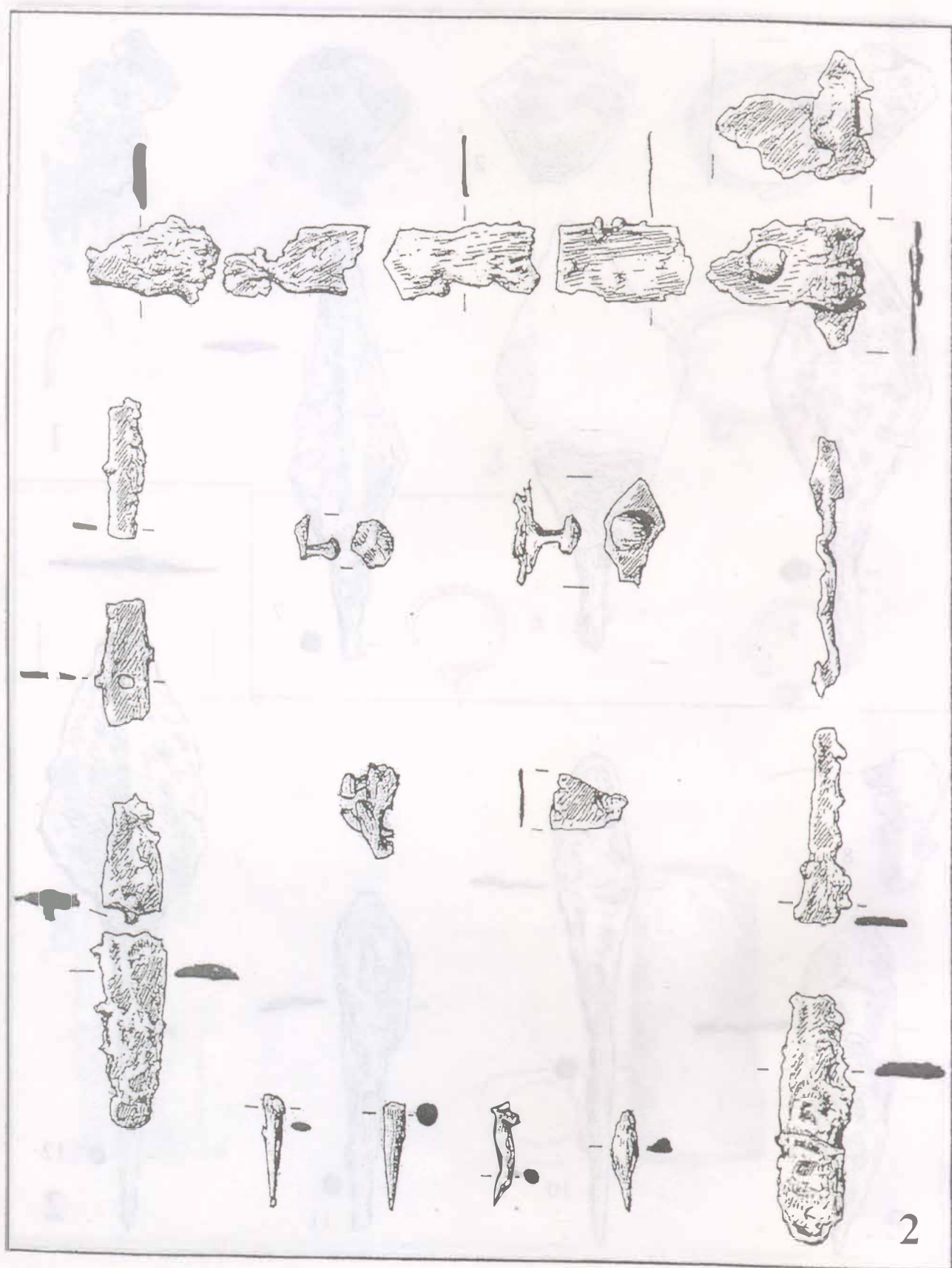

14. tábla: Hajdúböszörmény-Bodaszőlő, Büdöskút. 2. sír (1:1)

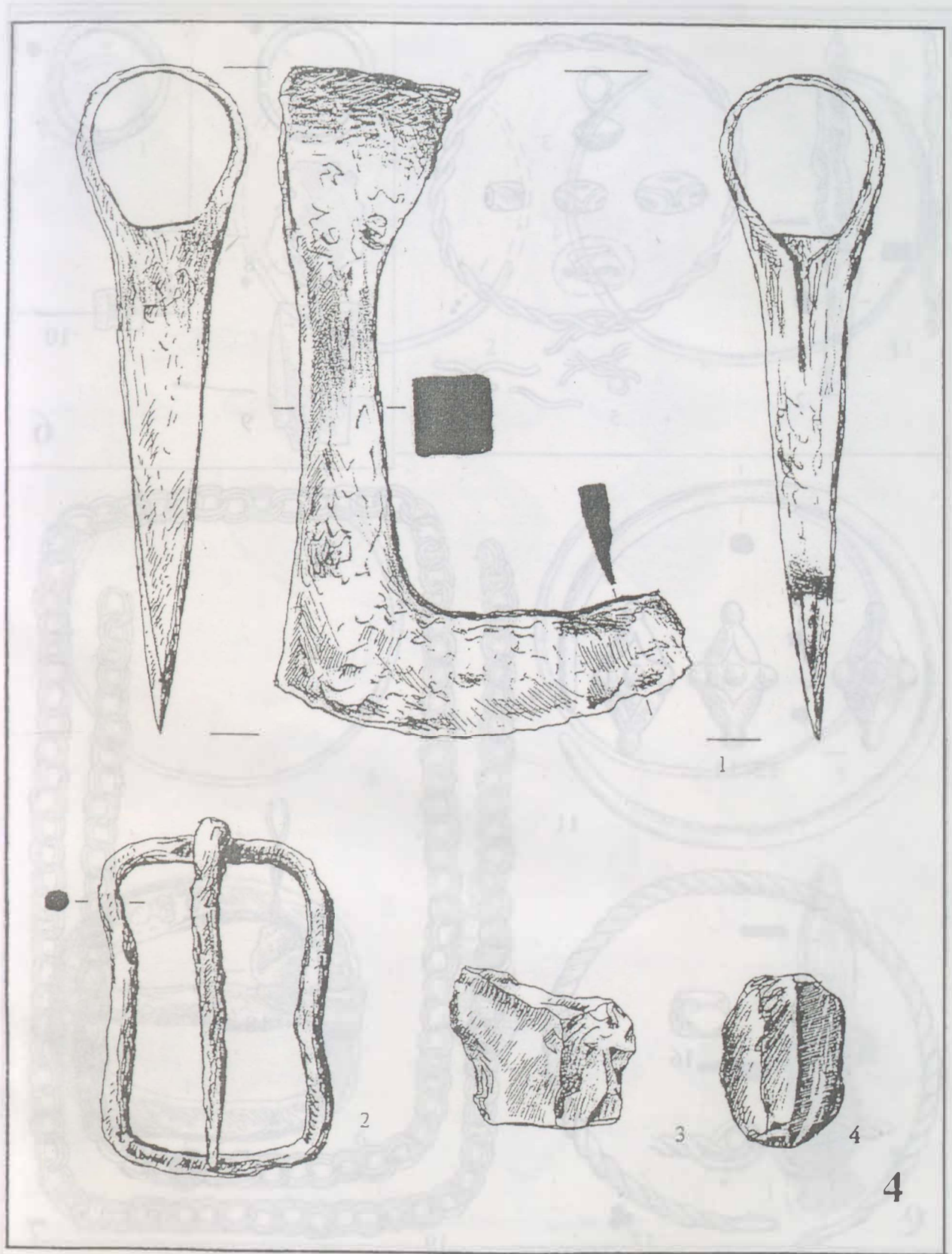

15. tábla: Hajdúböszörmény-Bodaszőlő, Büdöskút. 4. sír (1:1)

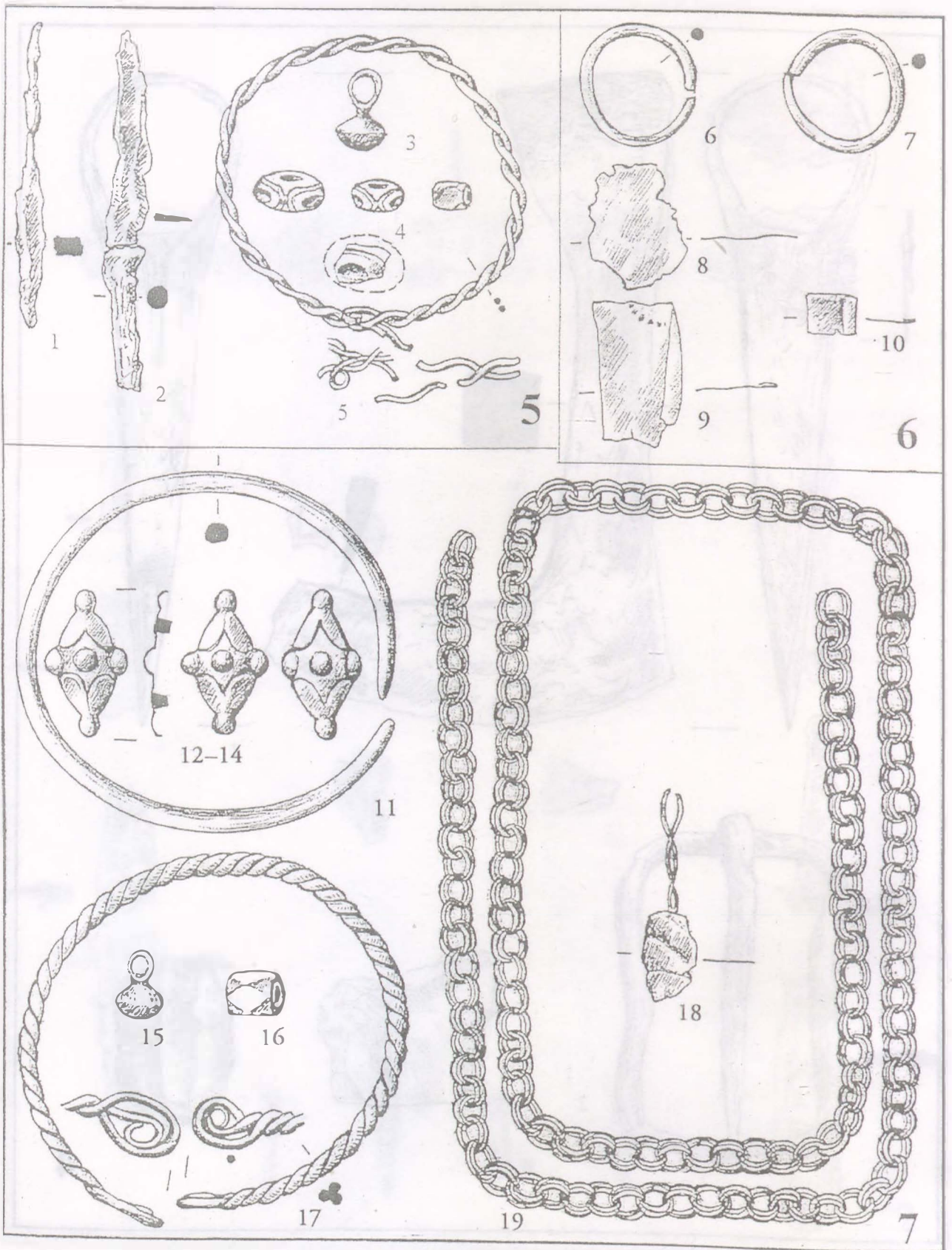

16. tábla: Hajdúböszörmény-Bodaszőlő, Büdöskút. 5-7. sír (1:1)

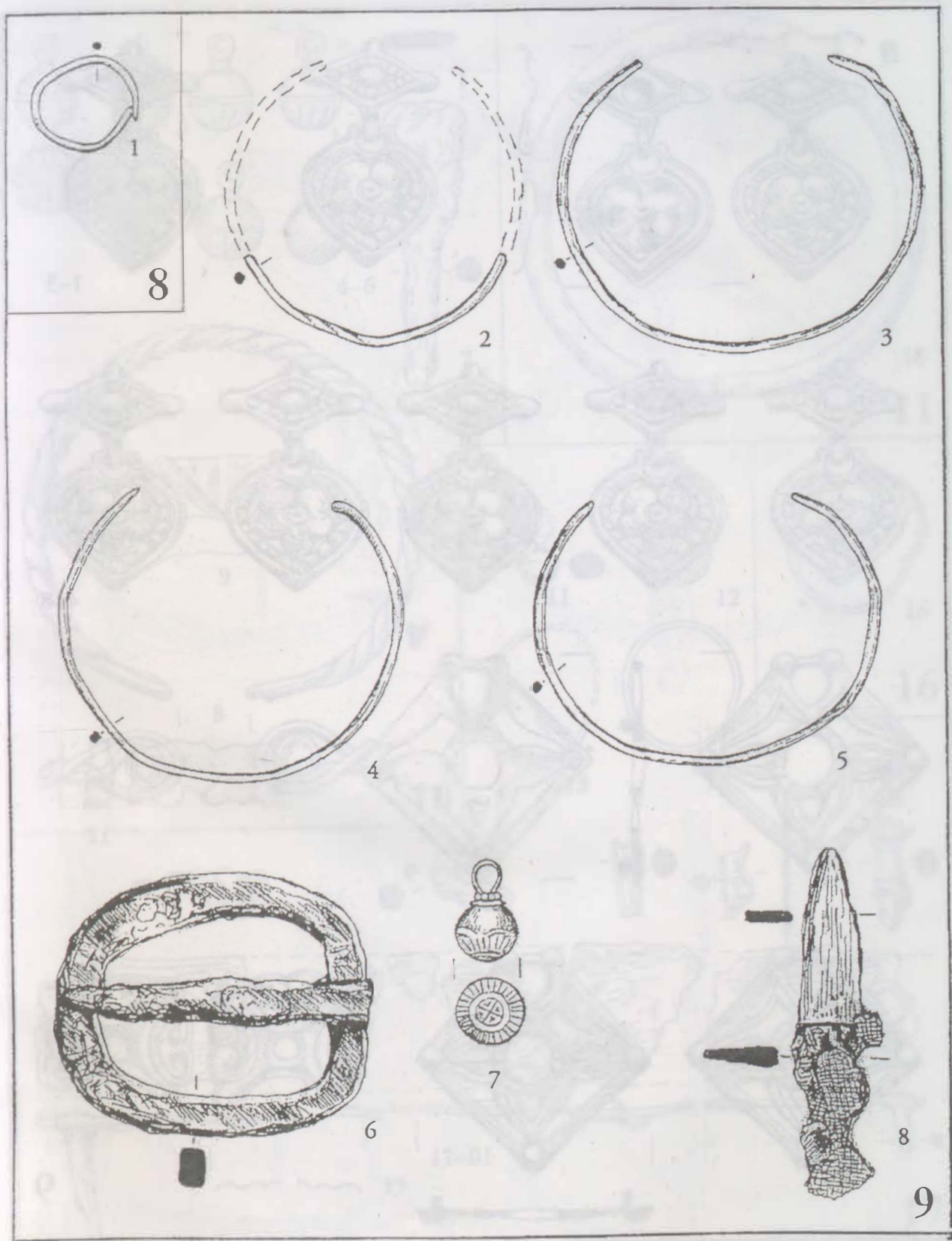

17. tábla: Hajdúböszörmény-Bodaszőlő, Büdöskút. 8-9. sír (1:1)

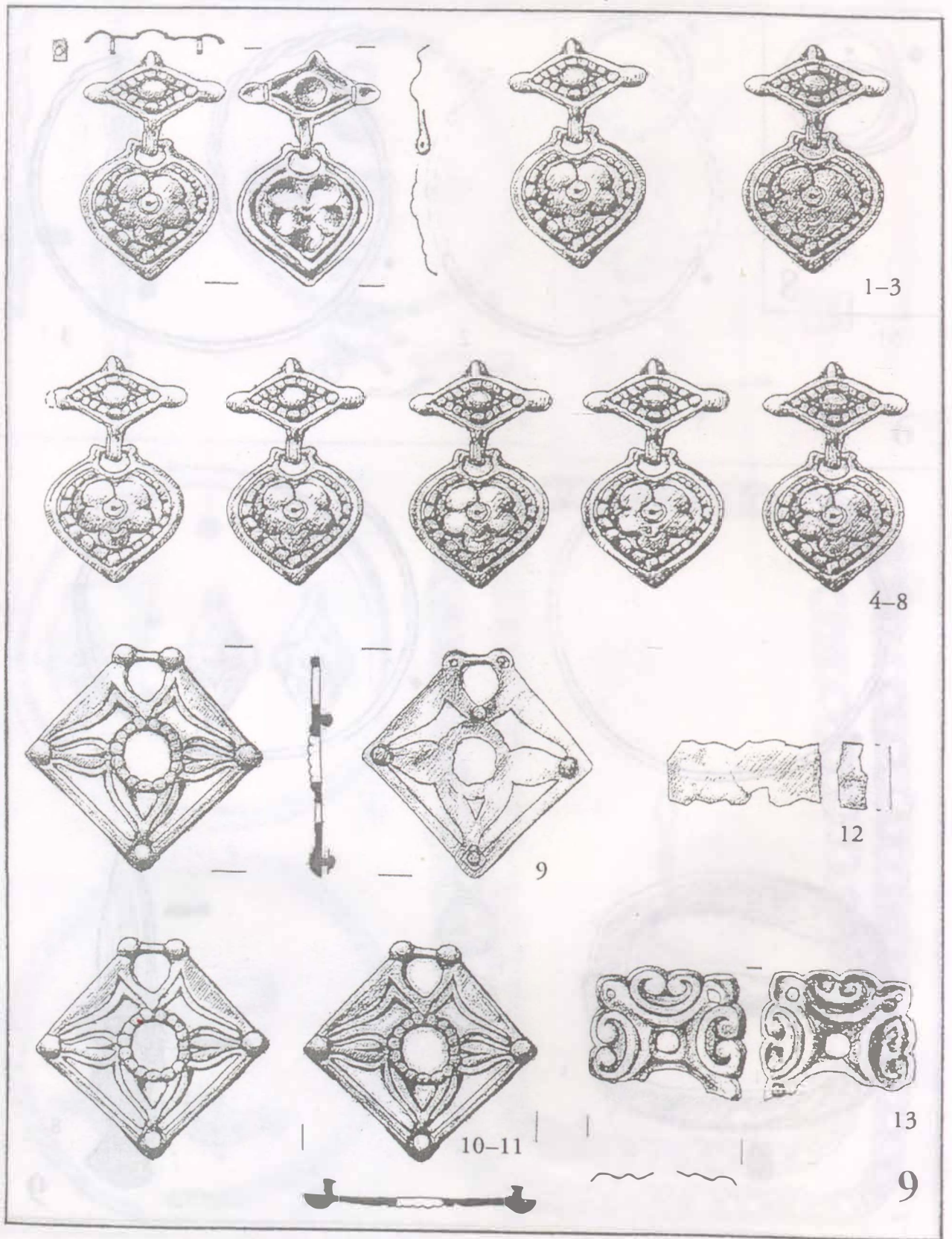

18. tábla: Hajdúböszörmény-Bodaszőlő, Büdöskút. 9. sír (1:1)

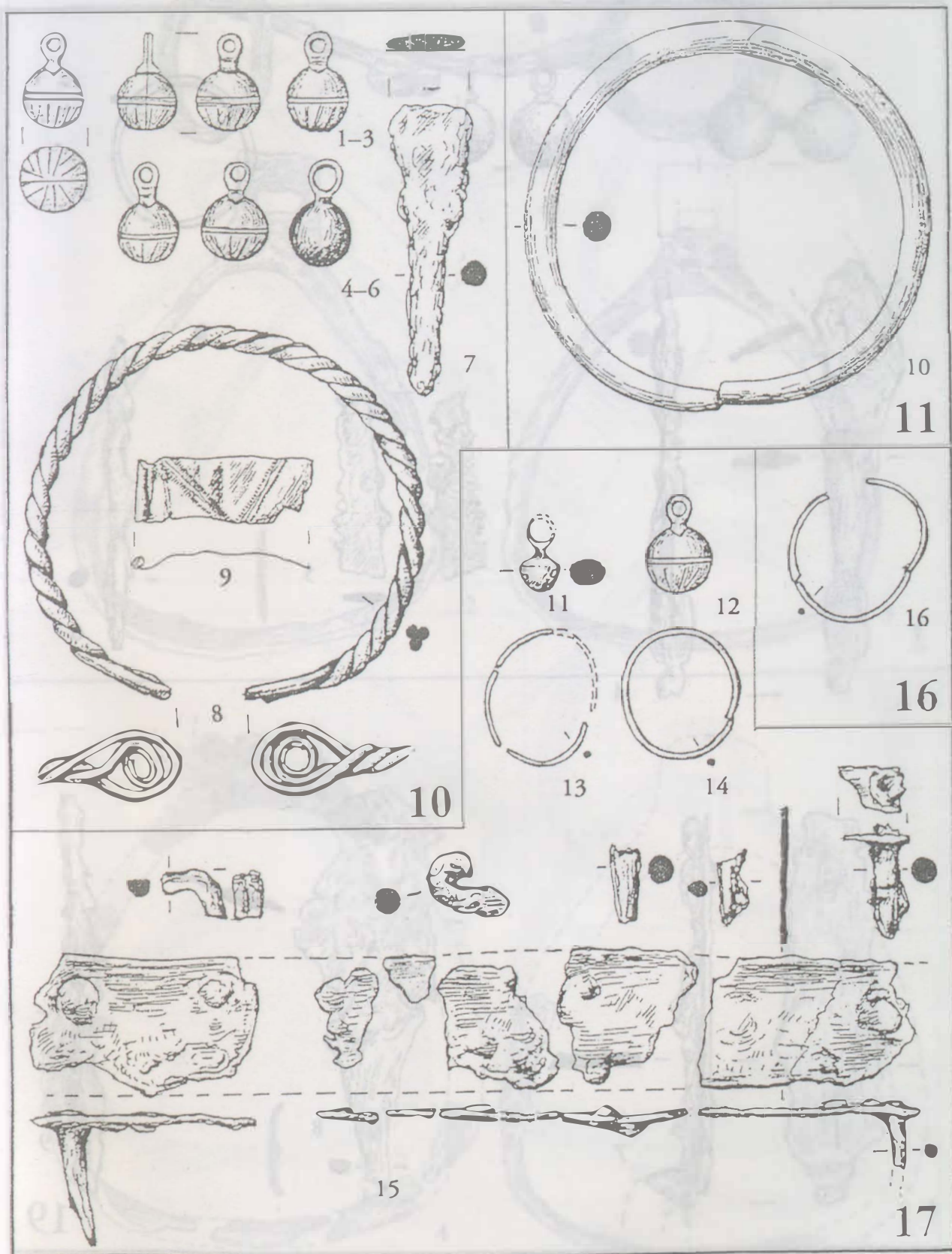

19. tábla: Hajdúbozormény-Bodaszőlő, Búdöskút. 10–11., 16–17. sír (1:1)

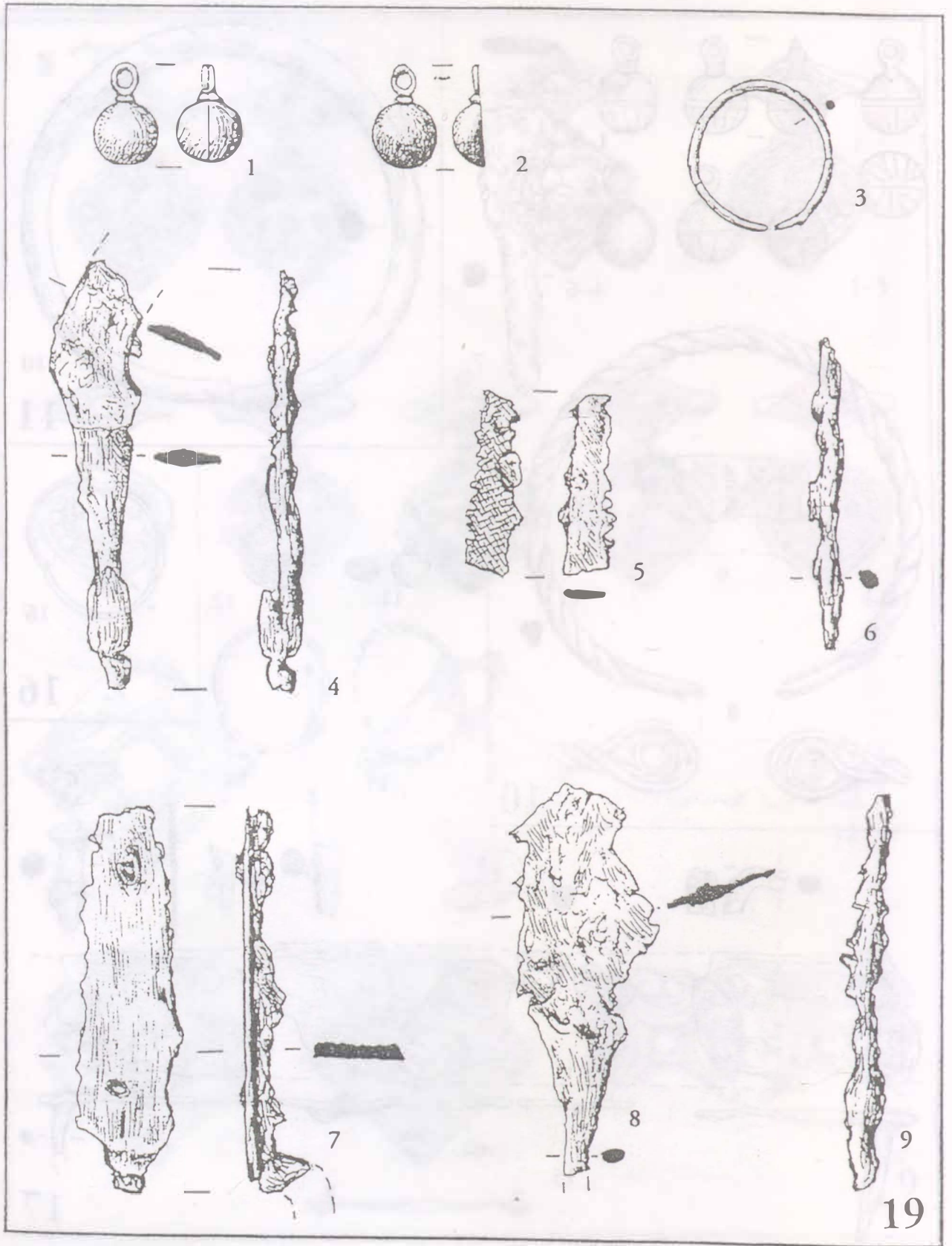

19

20. tábla: Hajdúböszörmény-Bodaszőlő, Búdöskút. 19. sír (1:1)

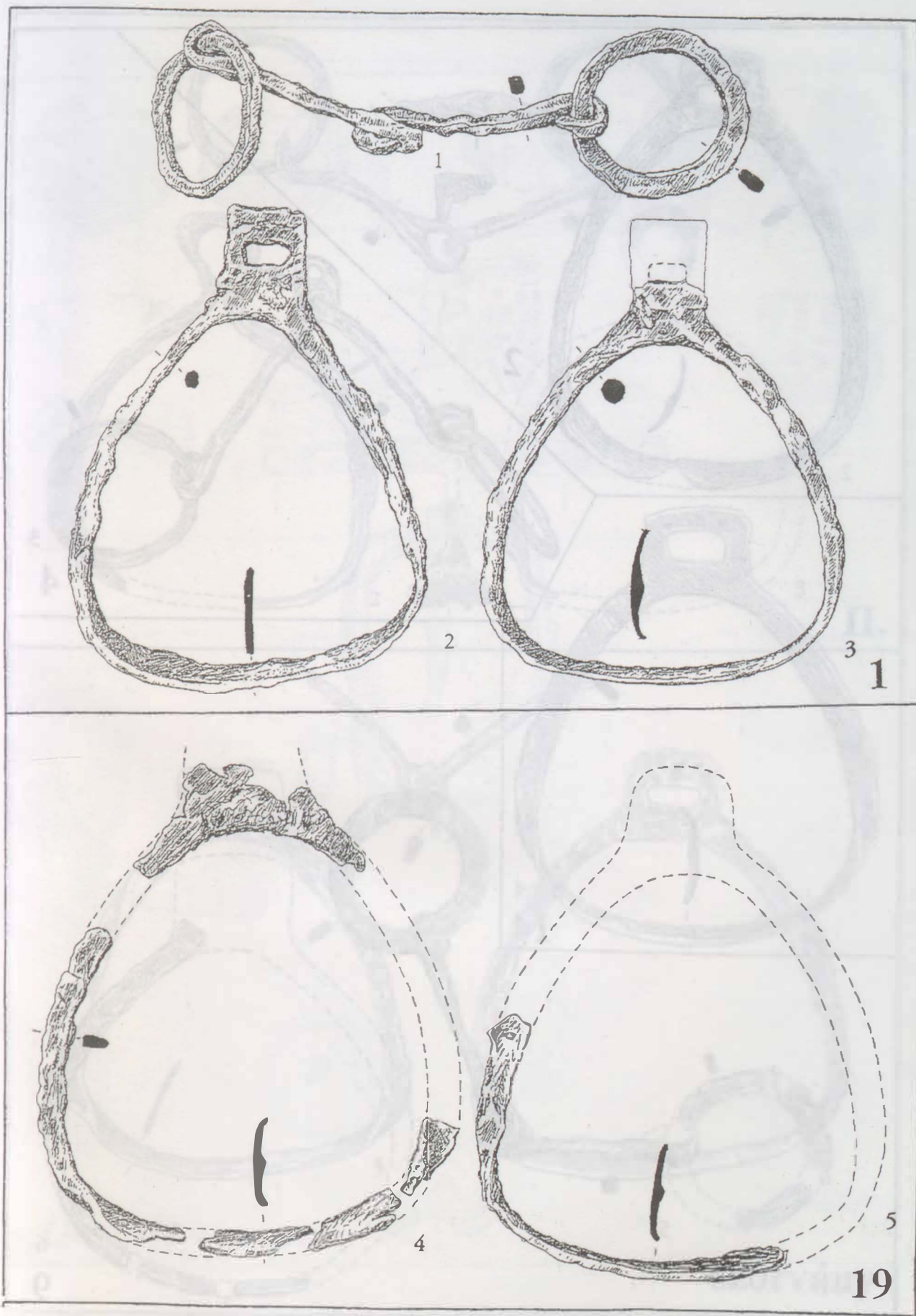

21. tábla: Hajdúböszörmény-Bodaszőlő, Büdöskút. 1., 19. sír (1:2)

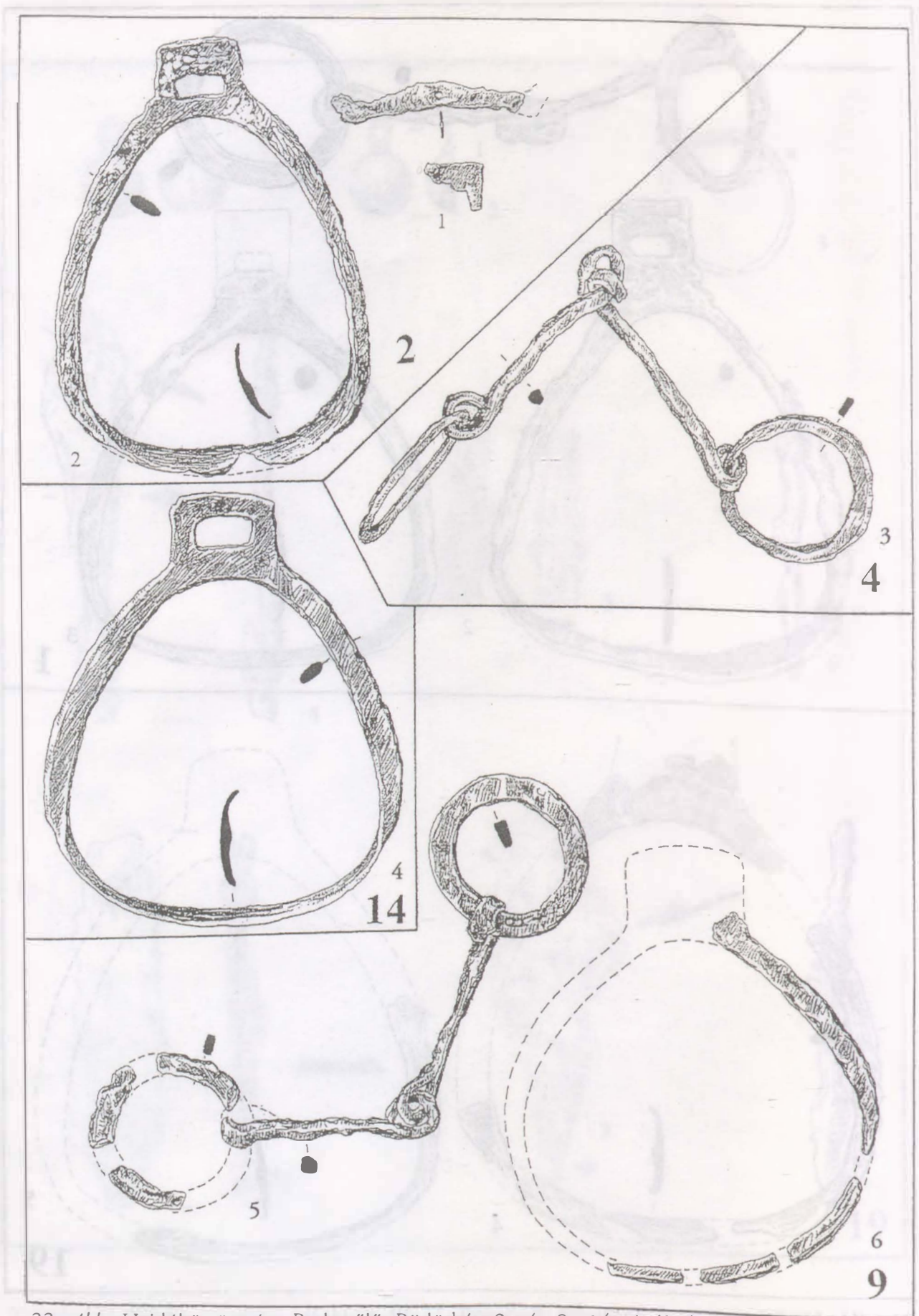

22. tábla: Hajdúböszörmény-Bodaszőlő, Büdöskút. 2., 4., 9., 14. sír (1:2)

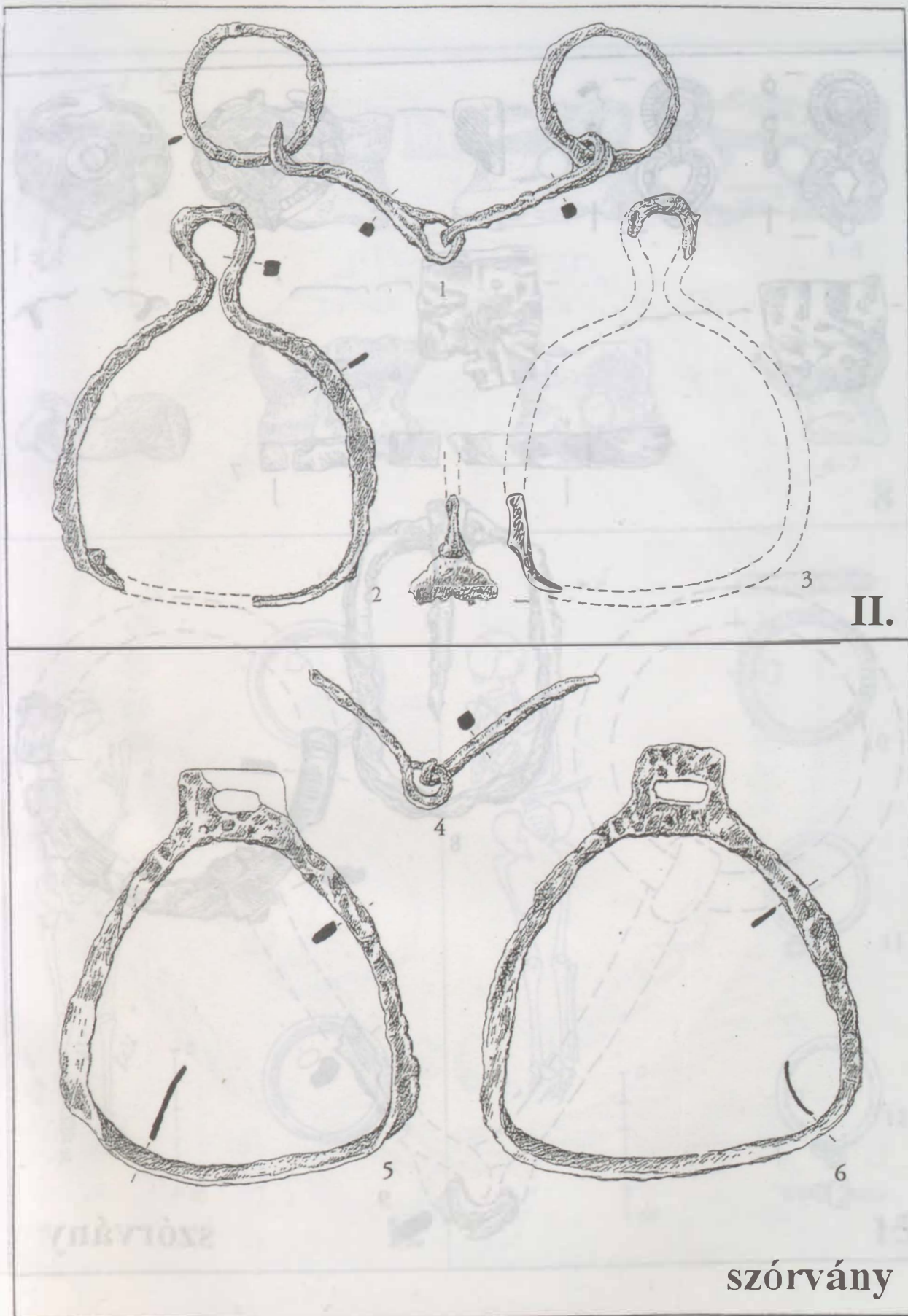

23. tábla: Hajdúböszörmény-Bodaszőlő, Büdöskút. II. sír és szórvány (1:2)

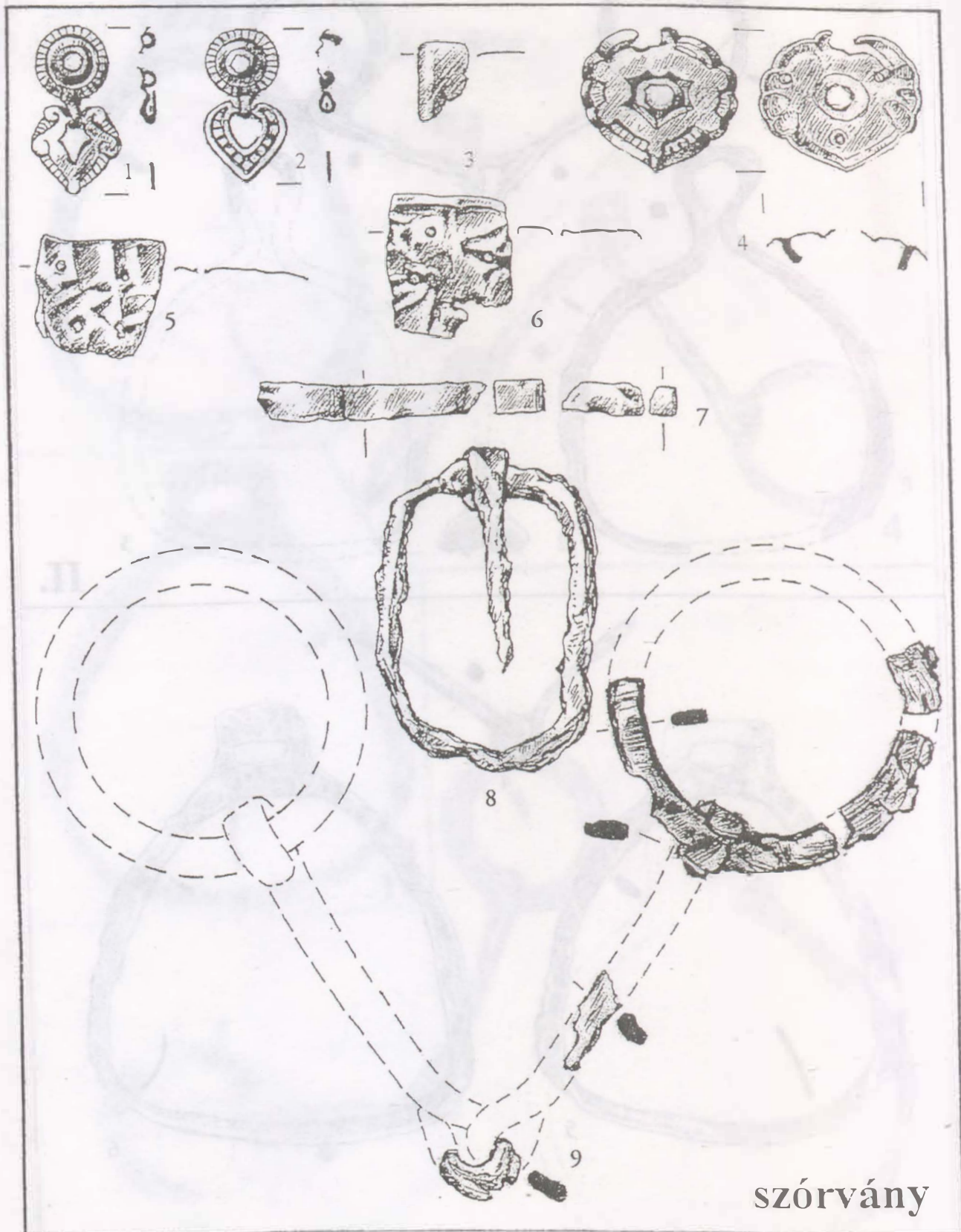

szórvány

24. tábla: Hajdúböszörmény-Bodaszőlő, Büdöskút. Szórvány (1:1)

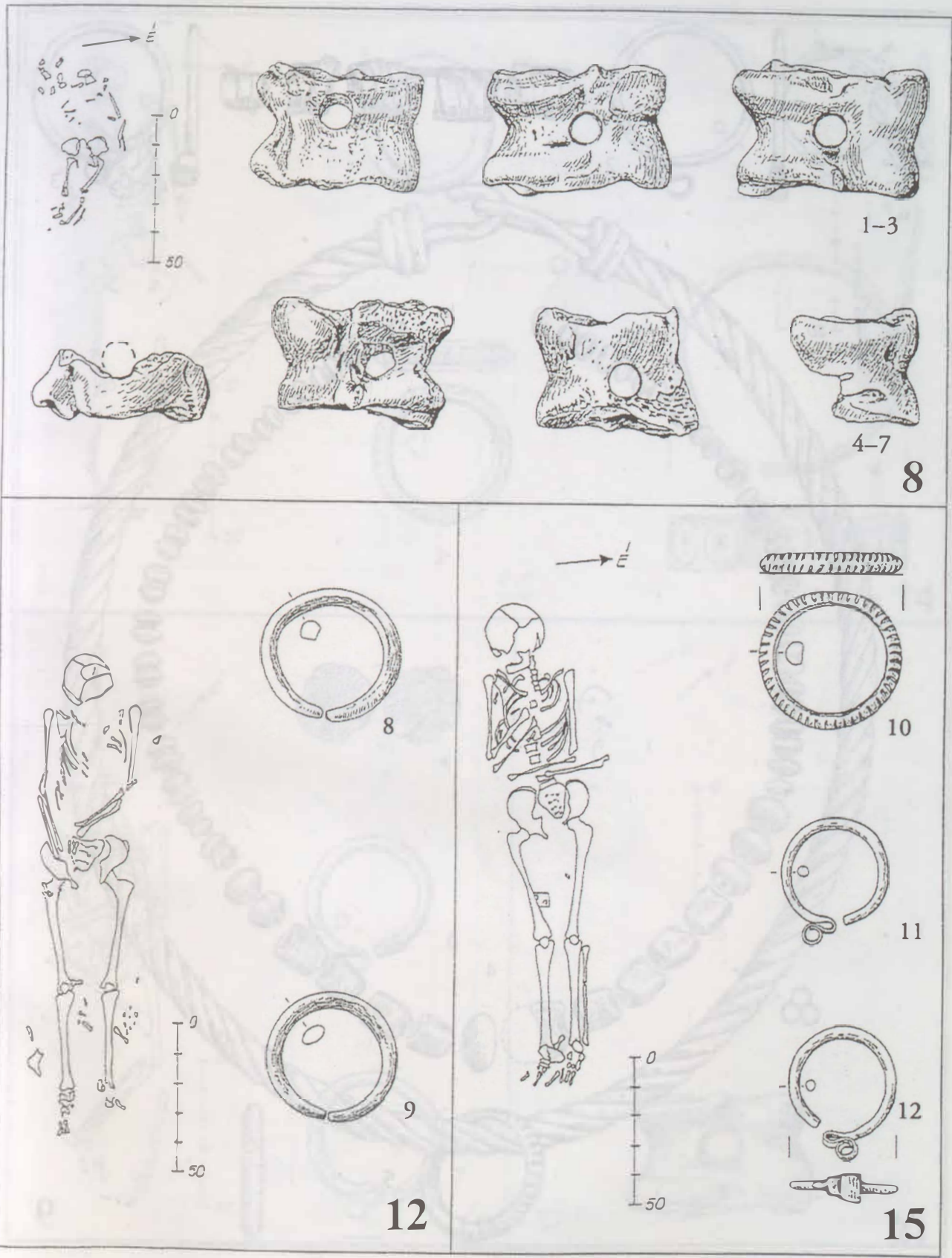

25. tábla: Hajdúszoboszló-Árkoshalom. 8., 12., 15. sír (1:1)

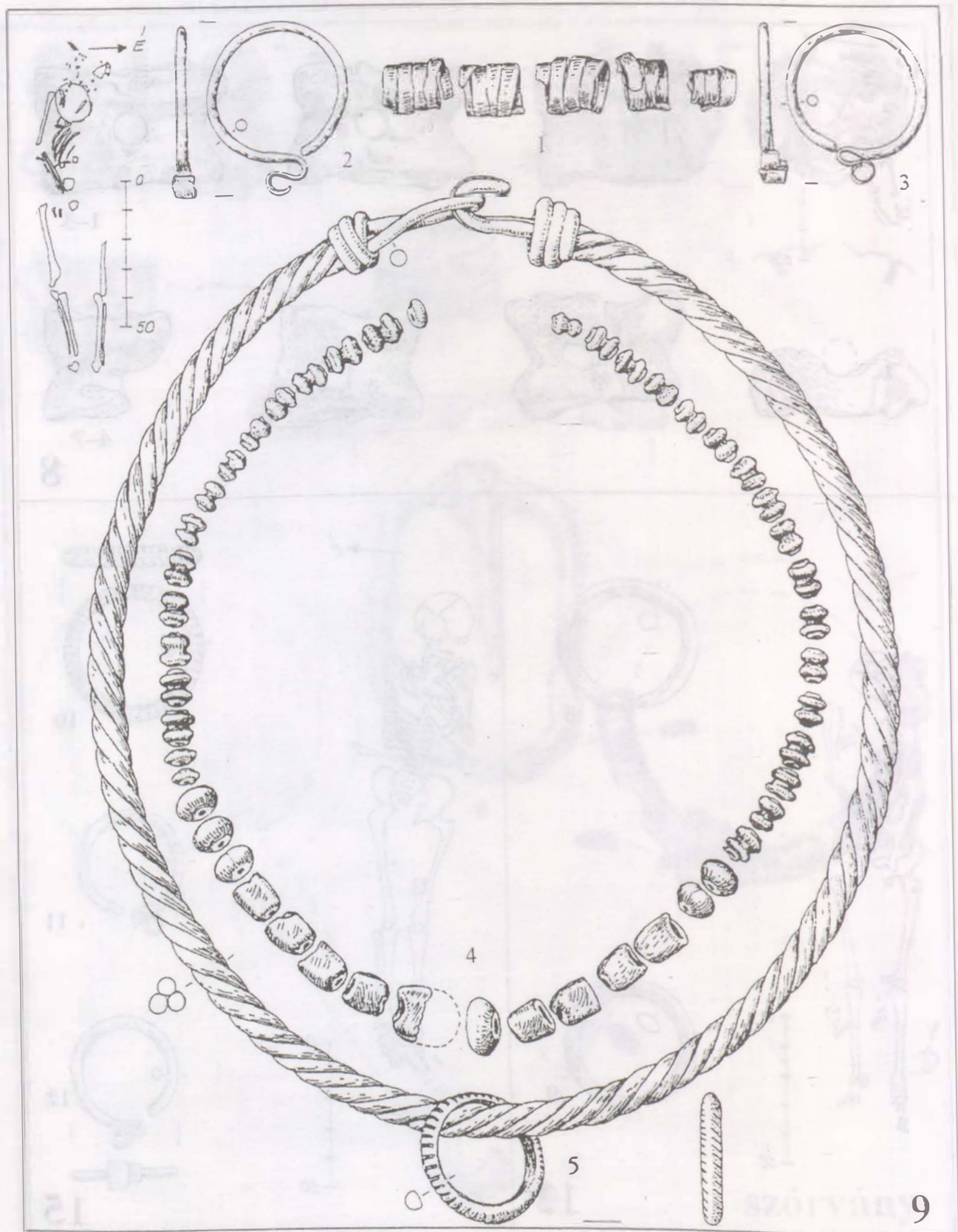

26. tábla: Hajdúszoboszló-Árkoshalom. 9. sír (1:1)

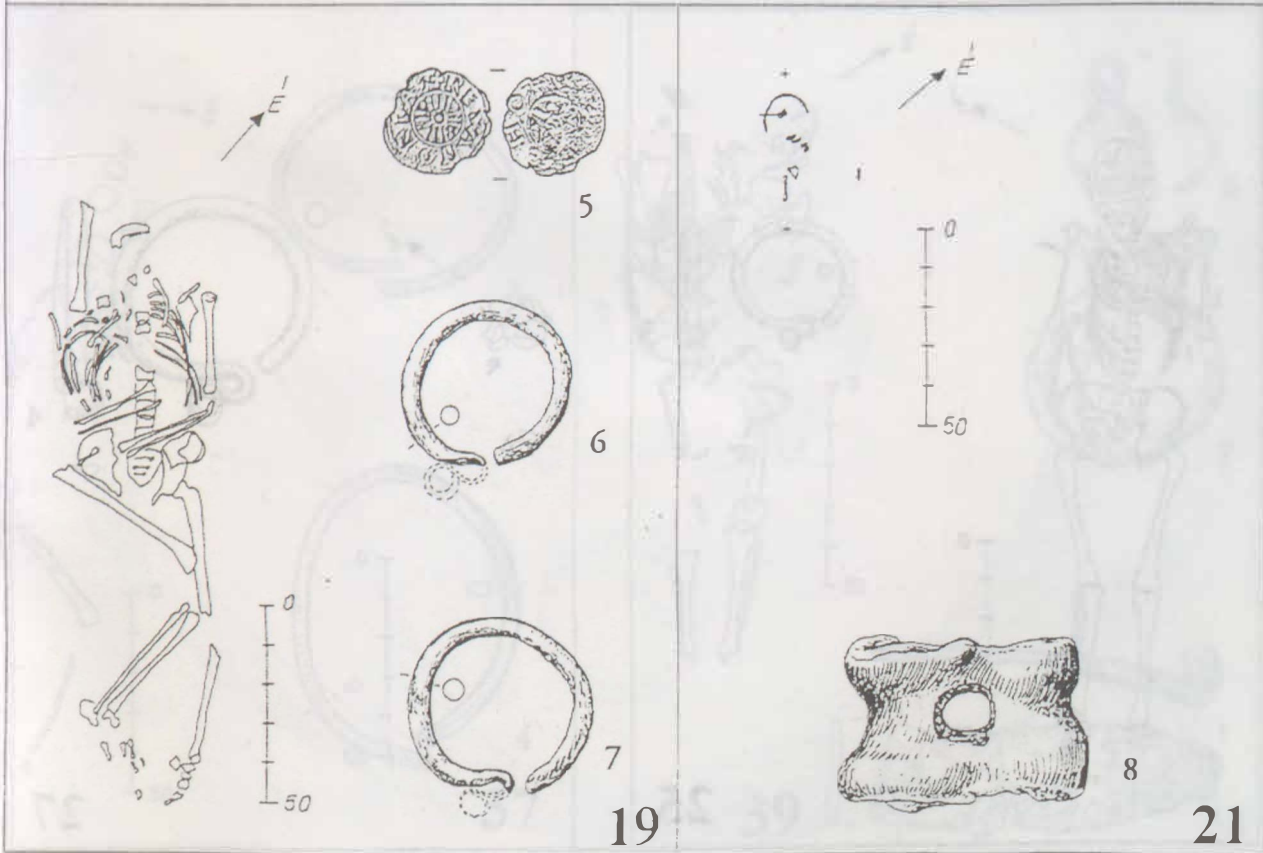
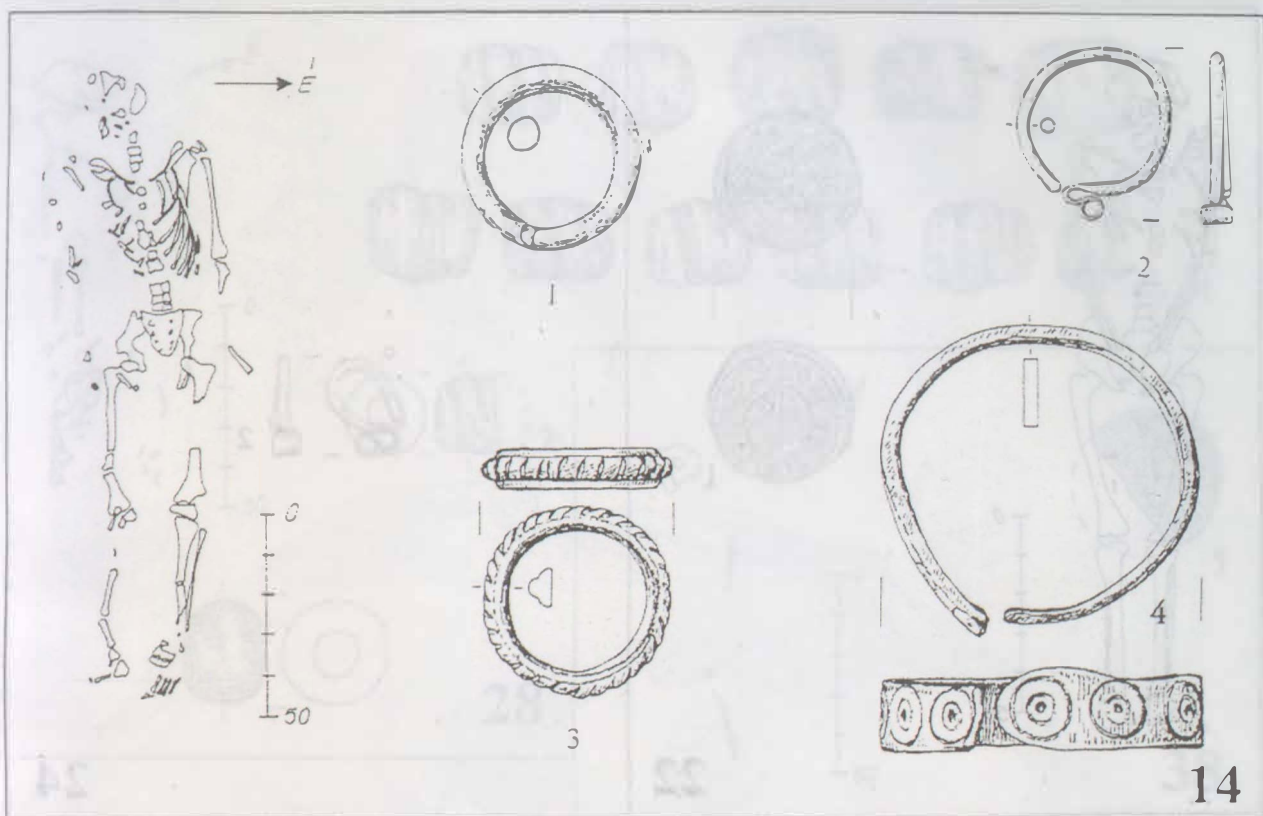

27. tábla: Hajdúszoboszló-Árkoshalom. 14., 19., 21. sír (1:1)

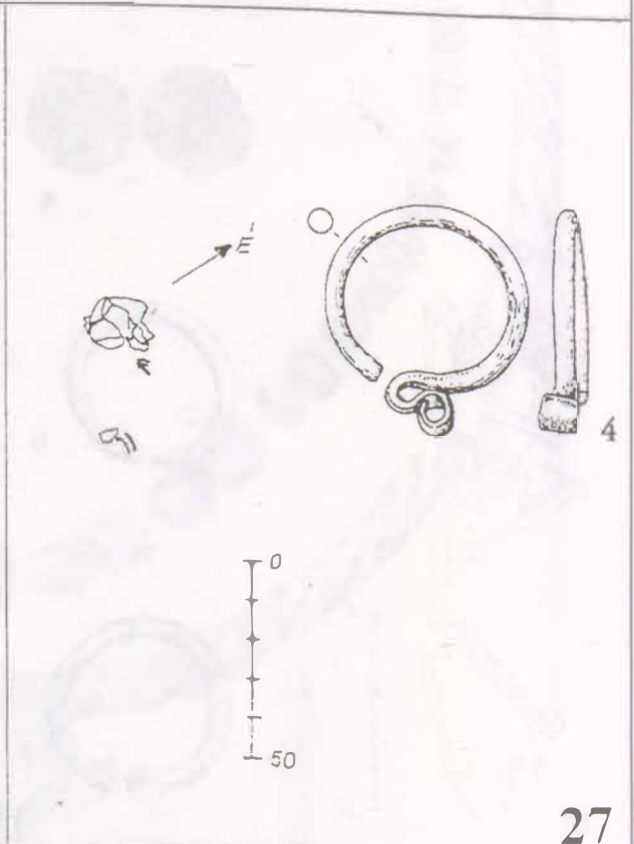
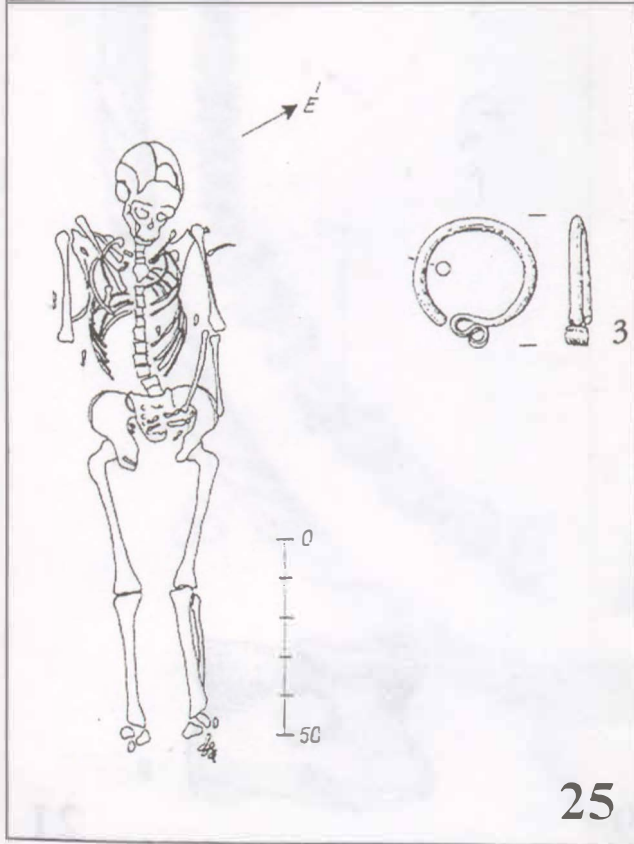
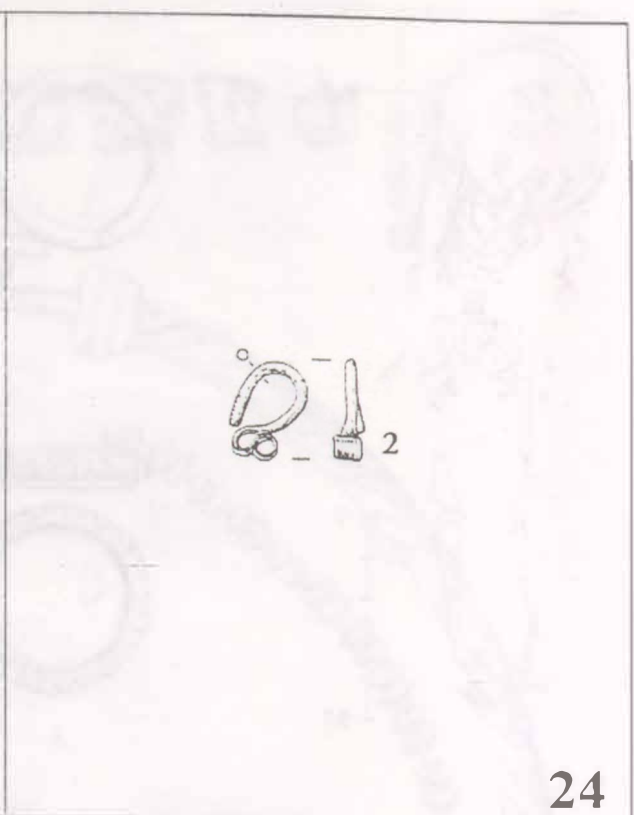
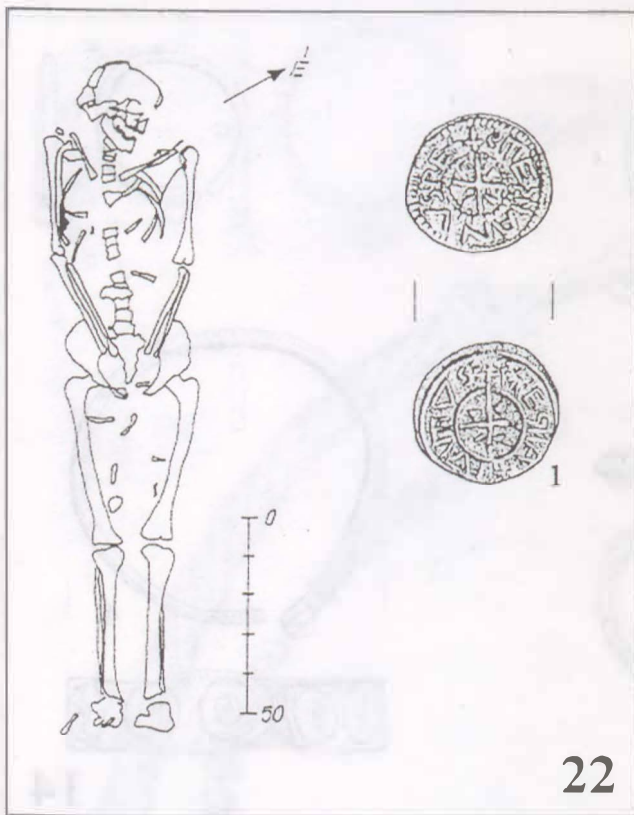

28. tábla: Hajdúszoboszló-Árkoshalom. 22., 24., 25., 27. sír (1:1)

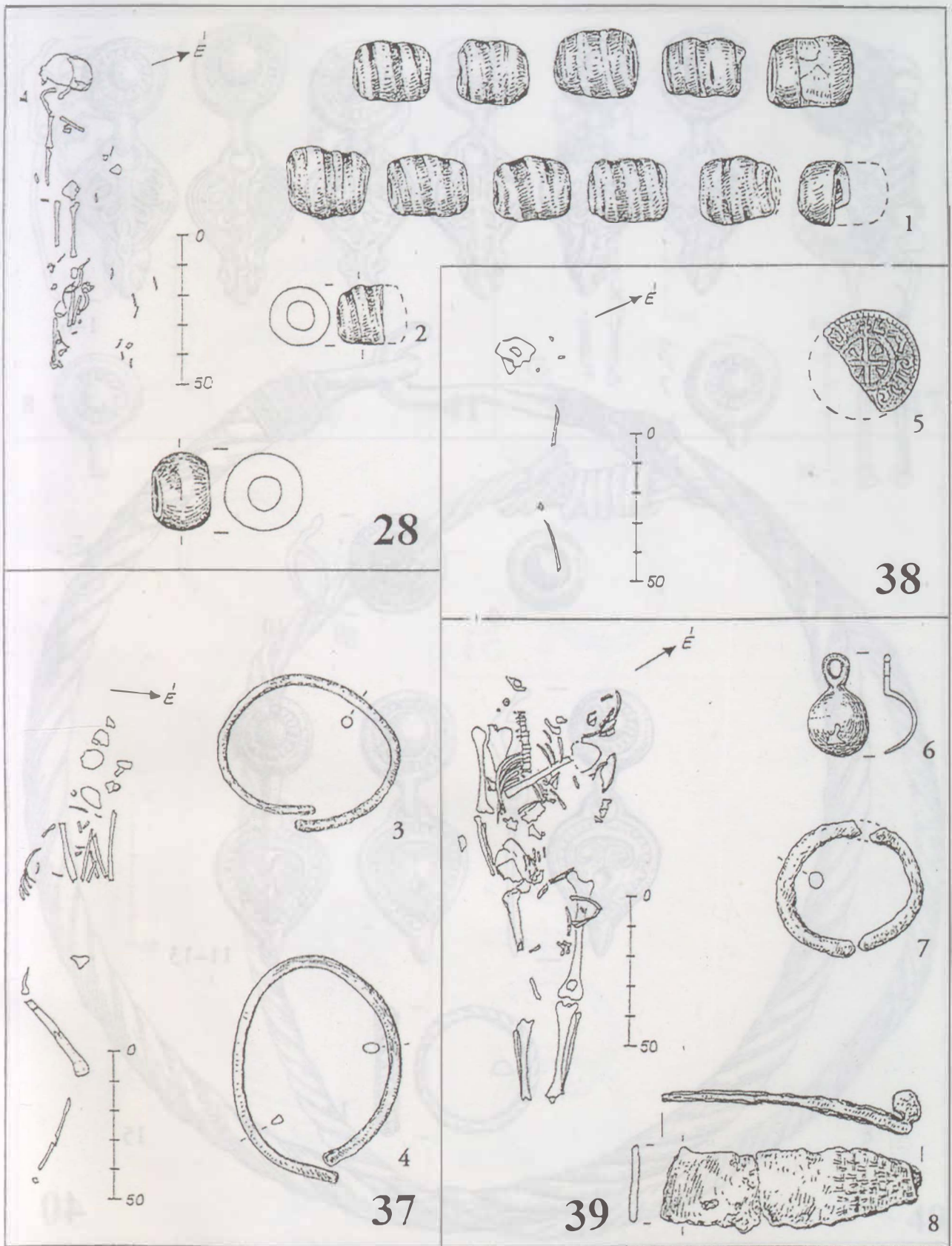

29. tábla: Hajdúszoboszló-Árkoshalom. 28., 37–39. sír (1:1)

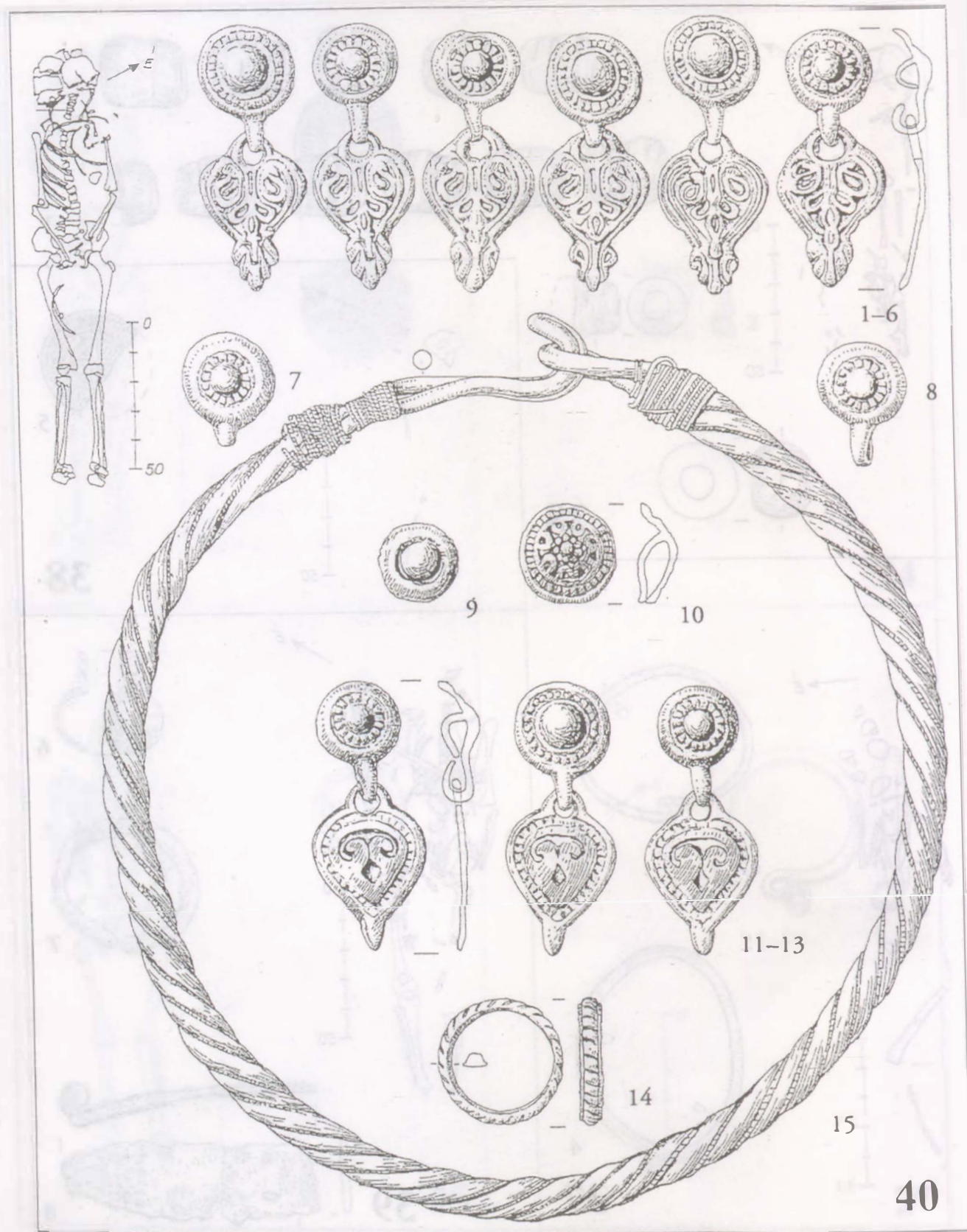

30. tábla: Hajdúszoboszló-Árkoshalom. 40. sír (1:1)

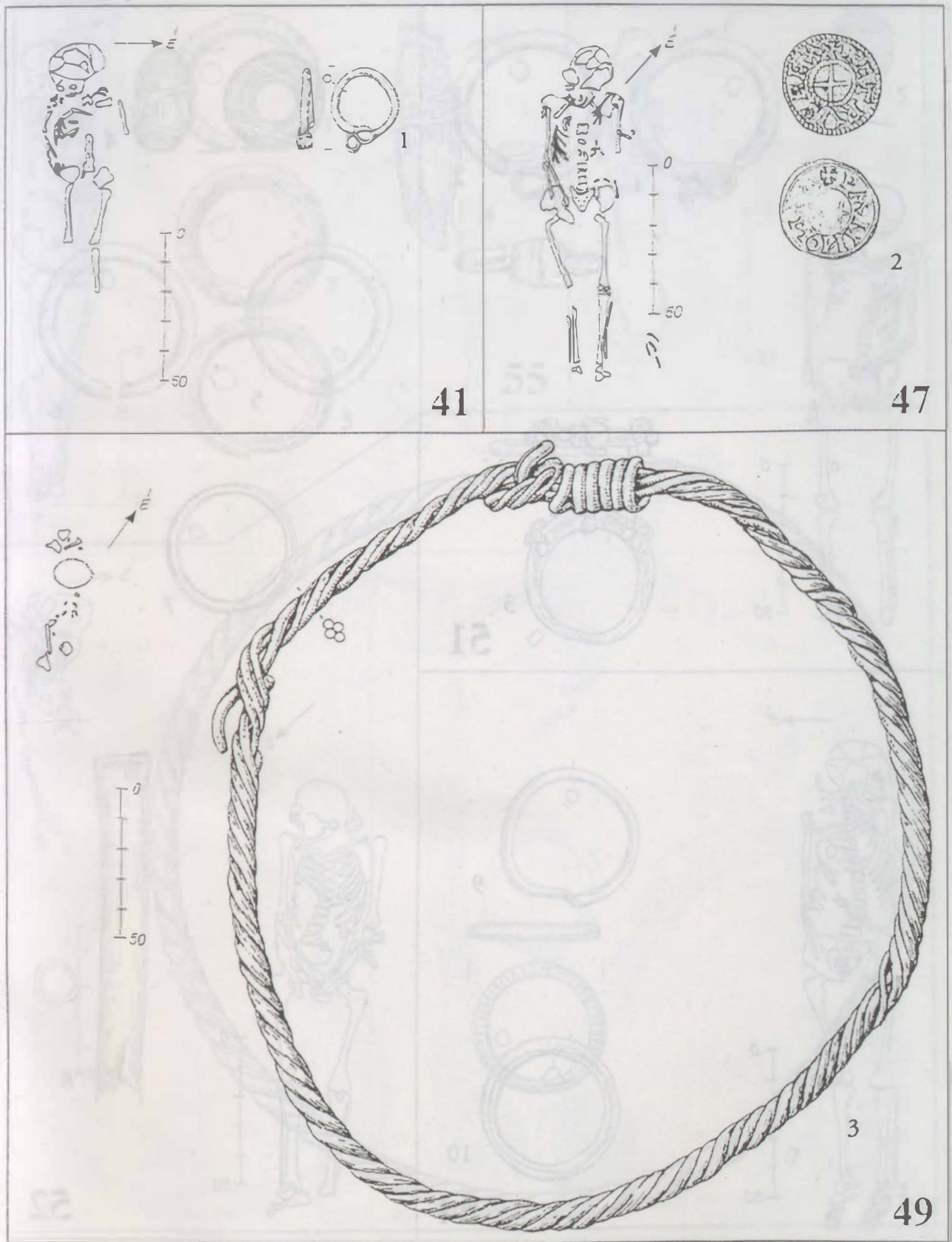

31. tábla: Hajdúszoboszló-Árkoshalom. 41., 47., 49. sír (1:1)

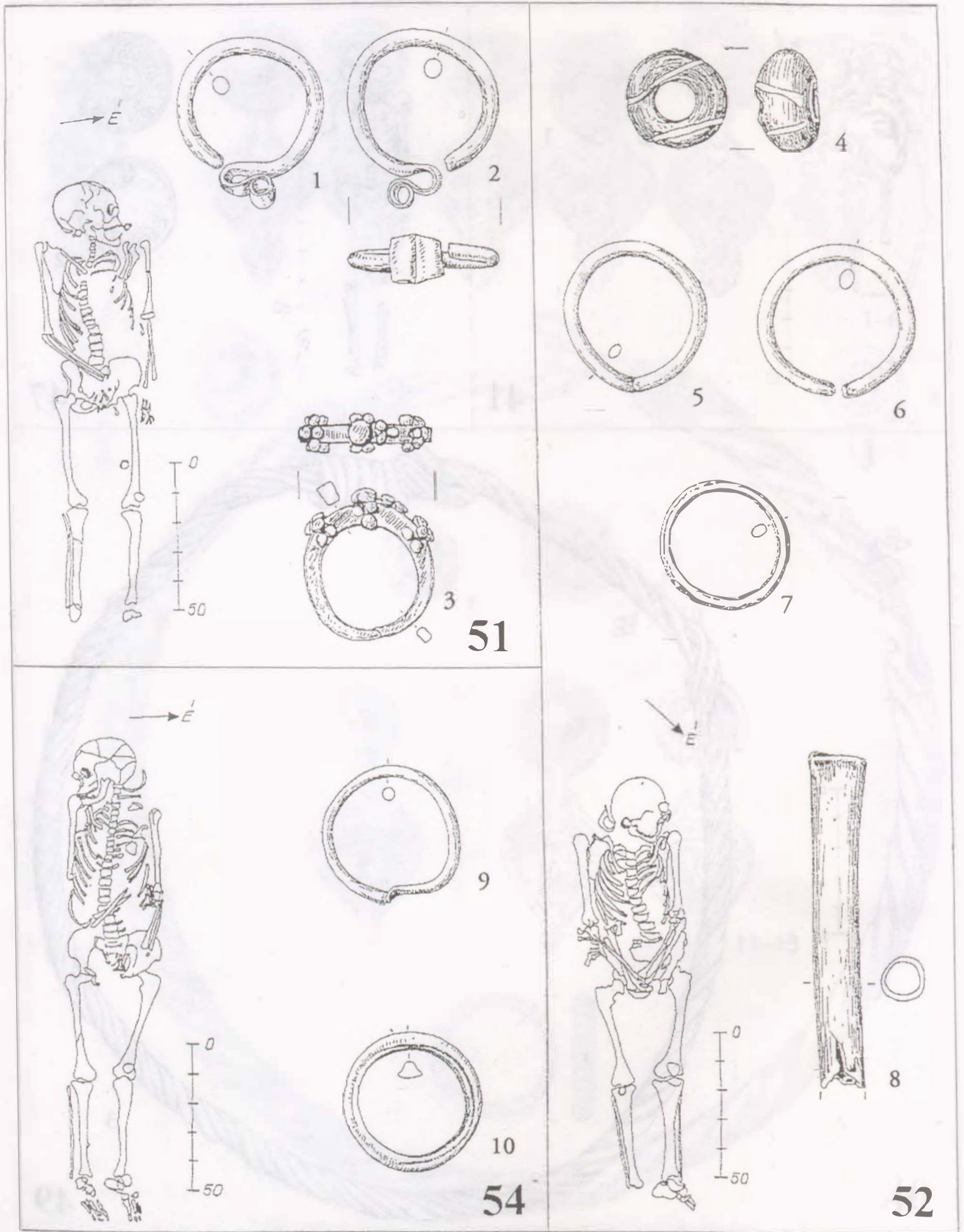

32. tábla: Hajdúszoboszló-Árkoshalom. 51-52., 54. sír (1:1)

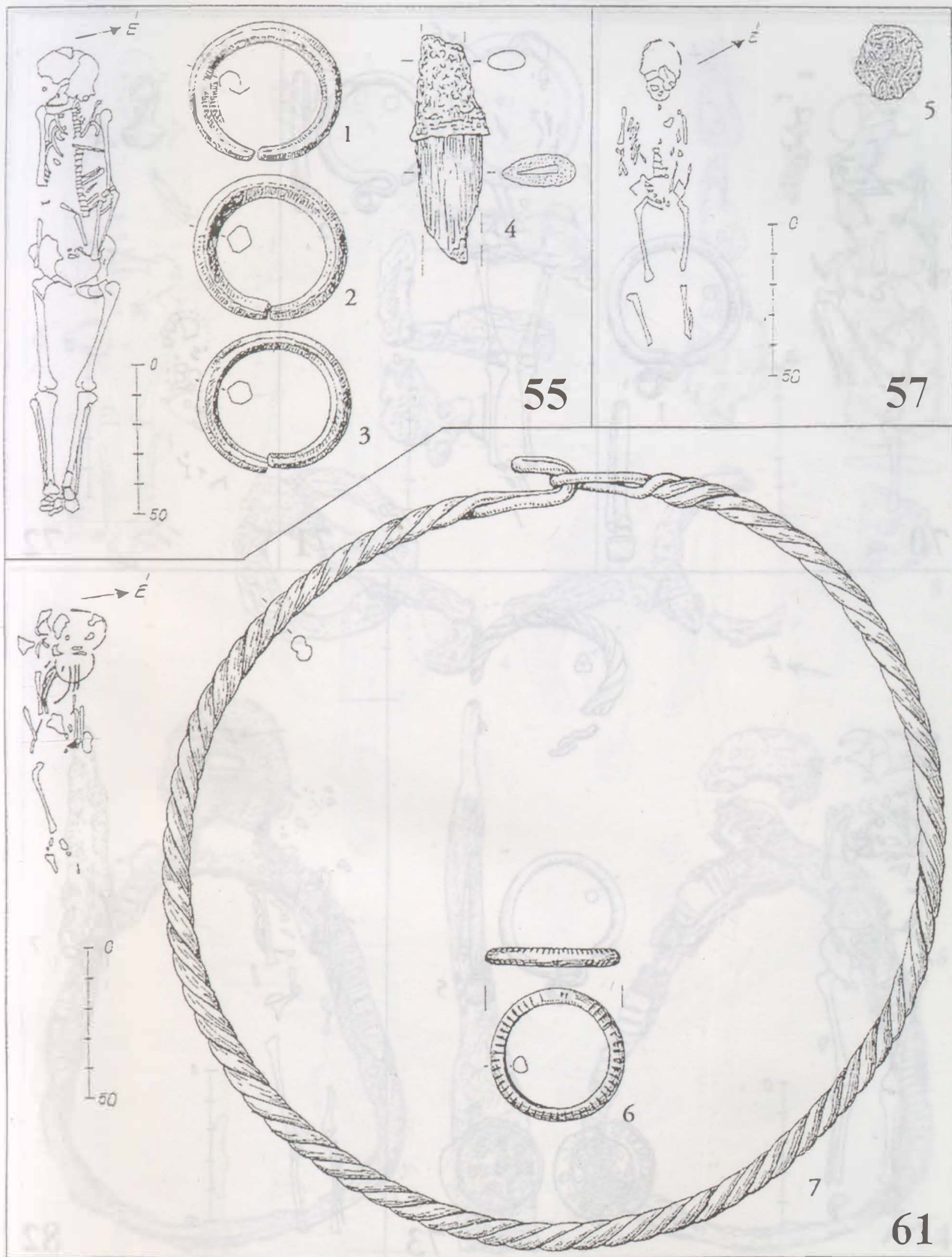

33. tábla: Hajdúszoboszló-Árkoshalom. 55., 57., 61. sír (1:1)

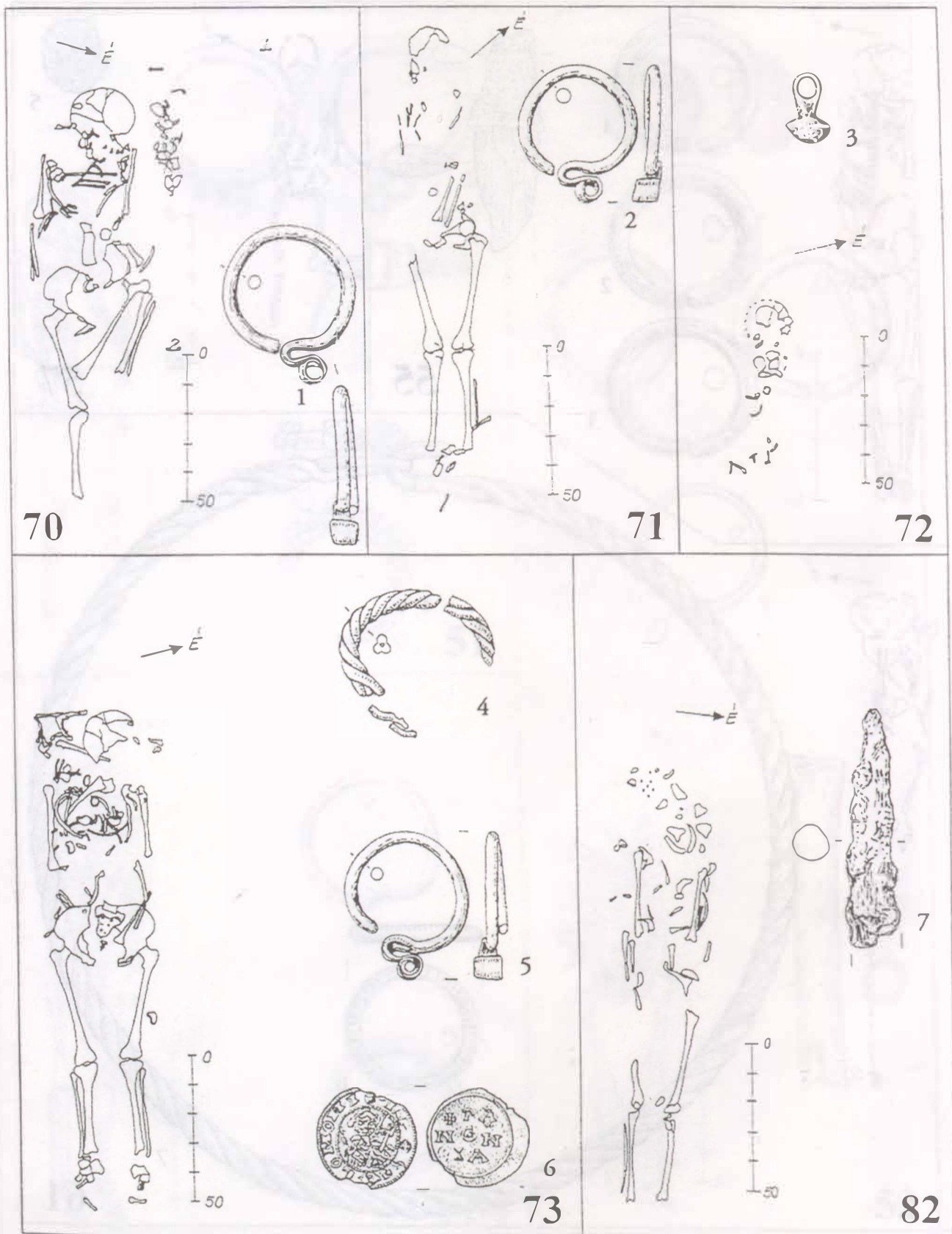

34. tábla: Hajdúszoboszló-Árkoshalom. 70-73., 82. sír (1:1)

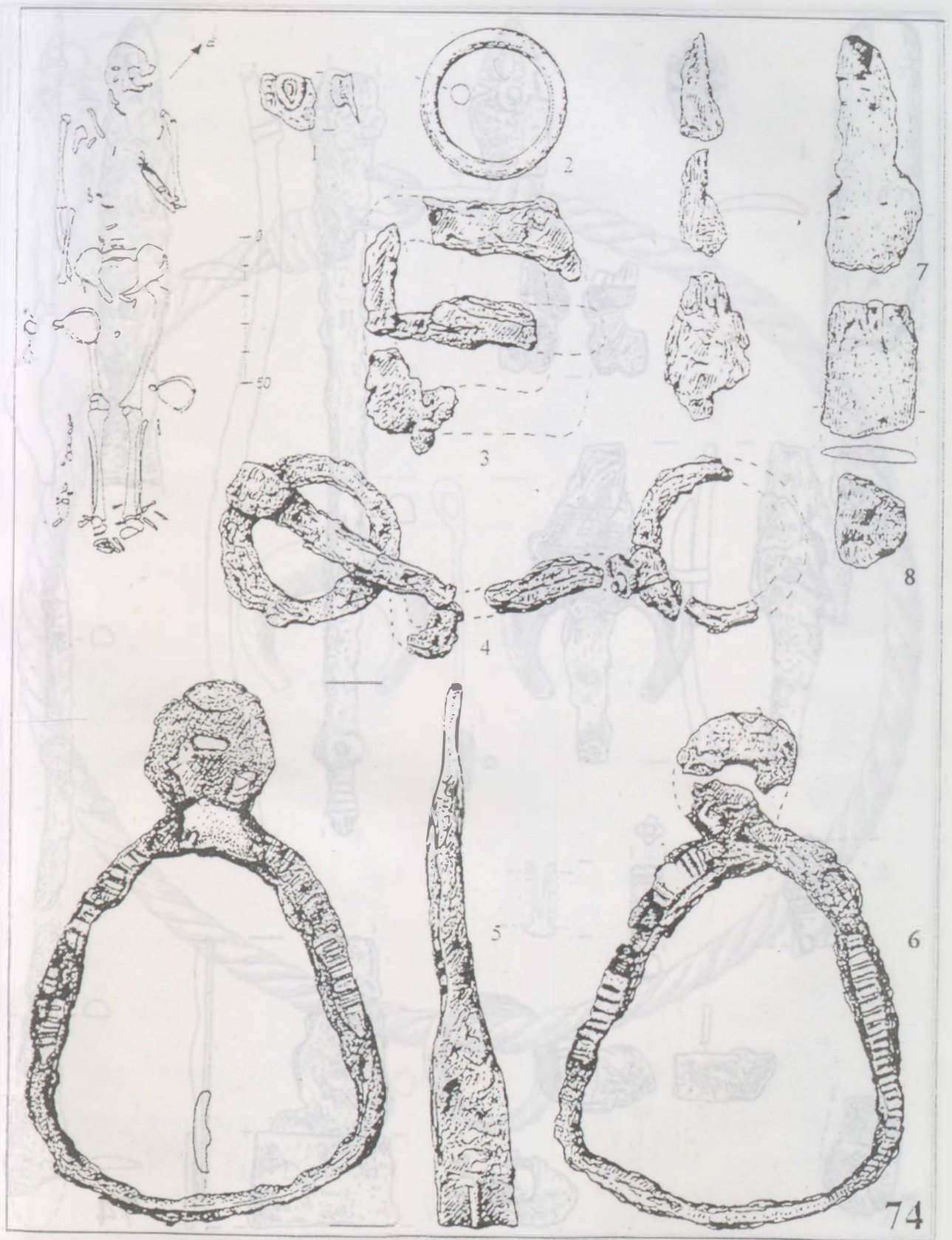

35. tábla: Hajdúszoboszló-Árkoshalom. 74.: sír (1-3, 7-8. 1:1; 4-6. 1:2)

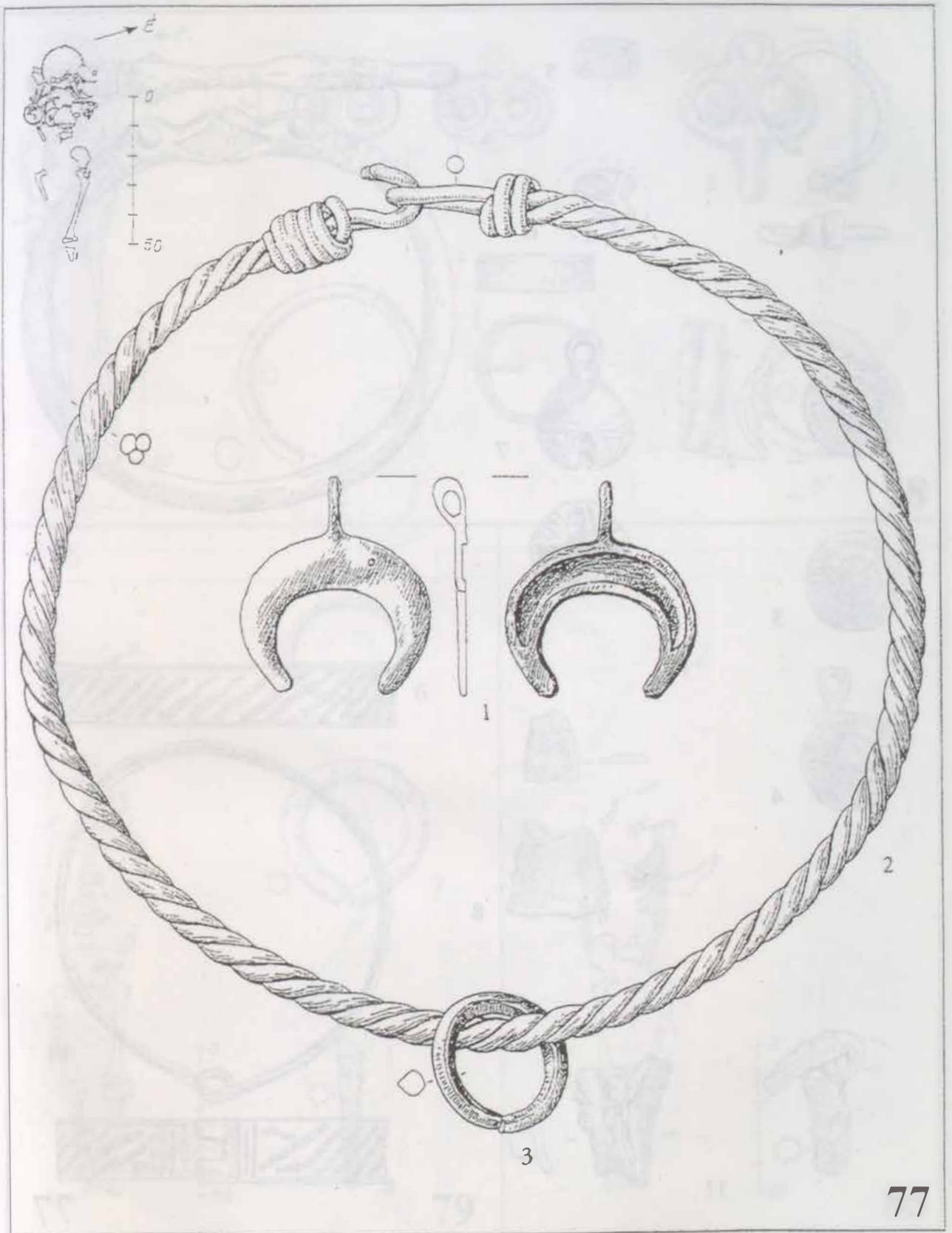

37. tábla: Hajdúszoboszló-Árkoshalom. 77. sír (1:1)

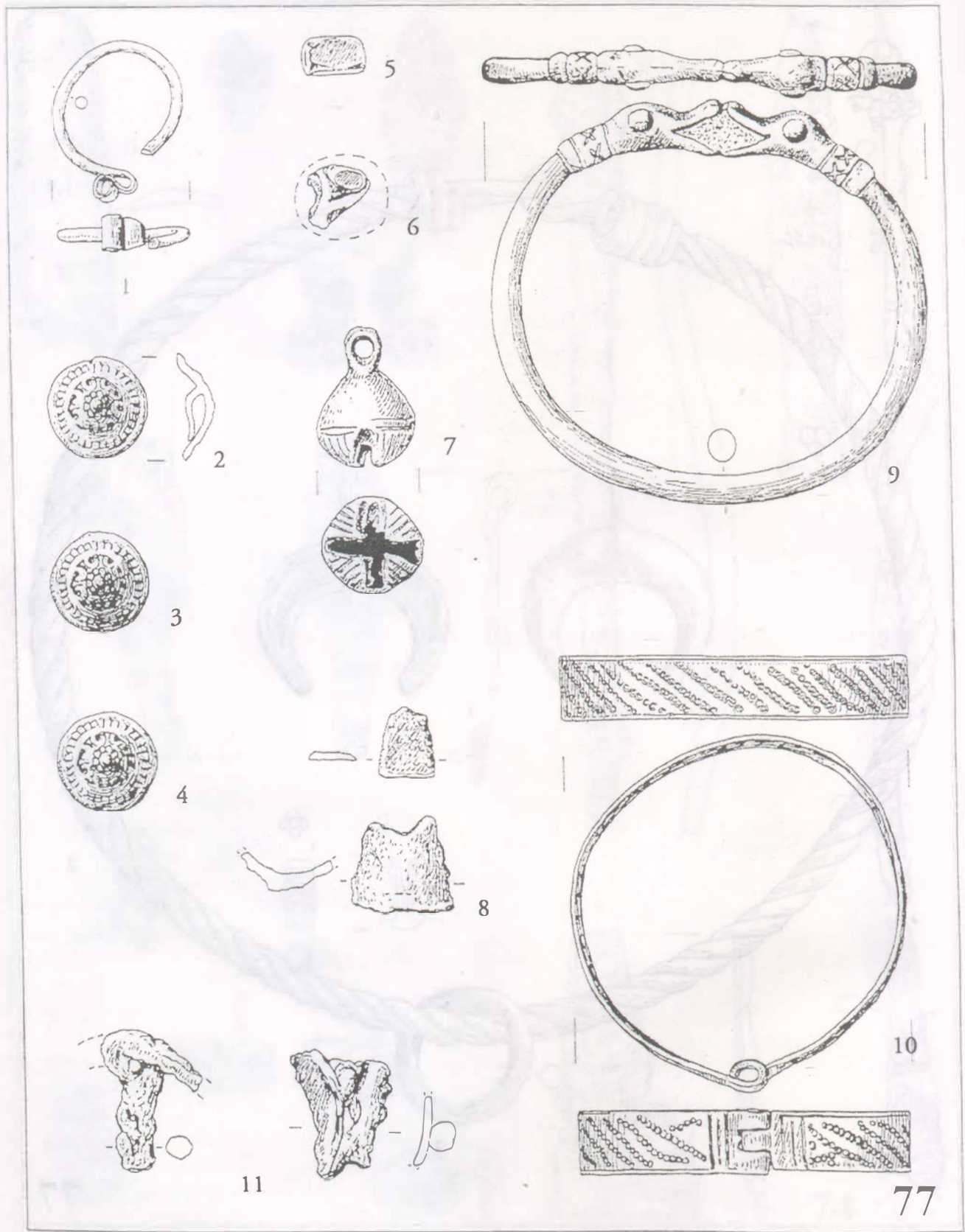

38. tábla: Hajdúszoboszló-Árkoshalom. 77. sír (1:1)

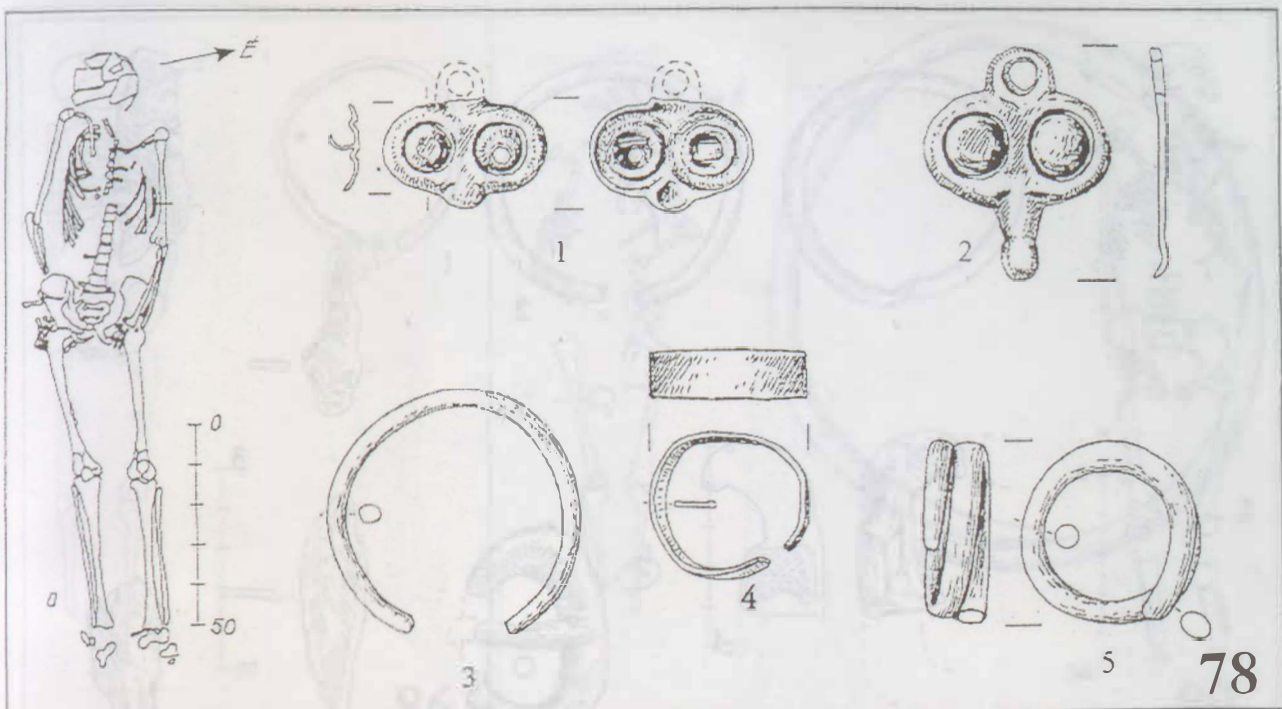

78

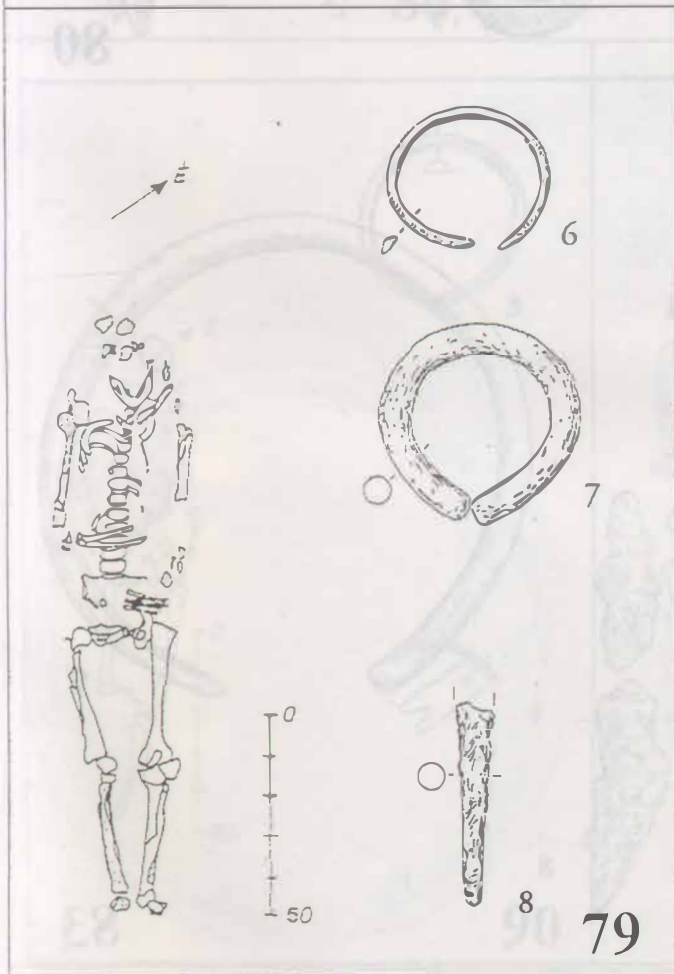

79

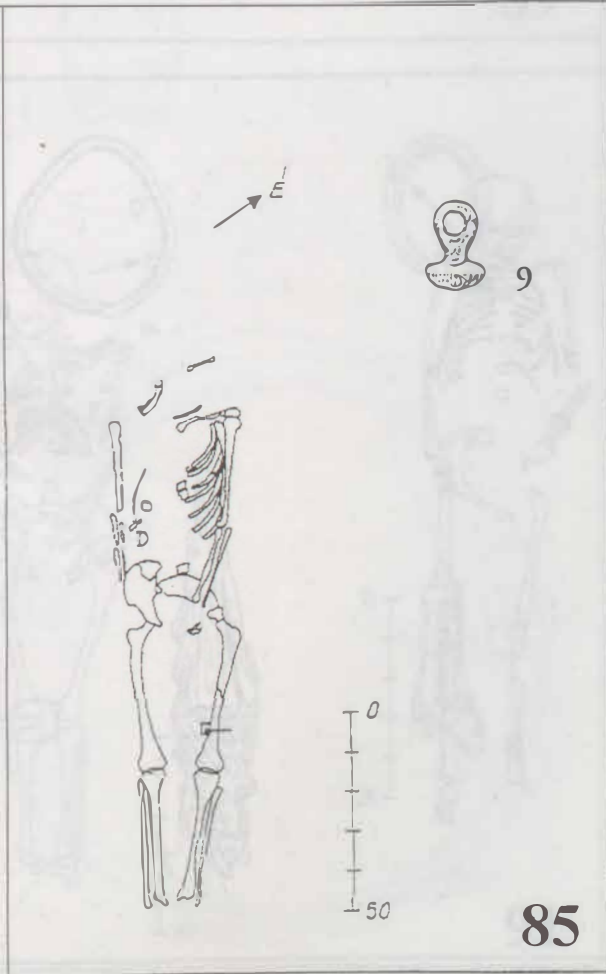

85

39. tábla: Hajdúszoboszló-Árkoshalom. 78-79., 85. sír (1:1)

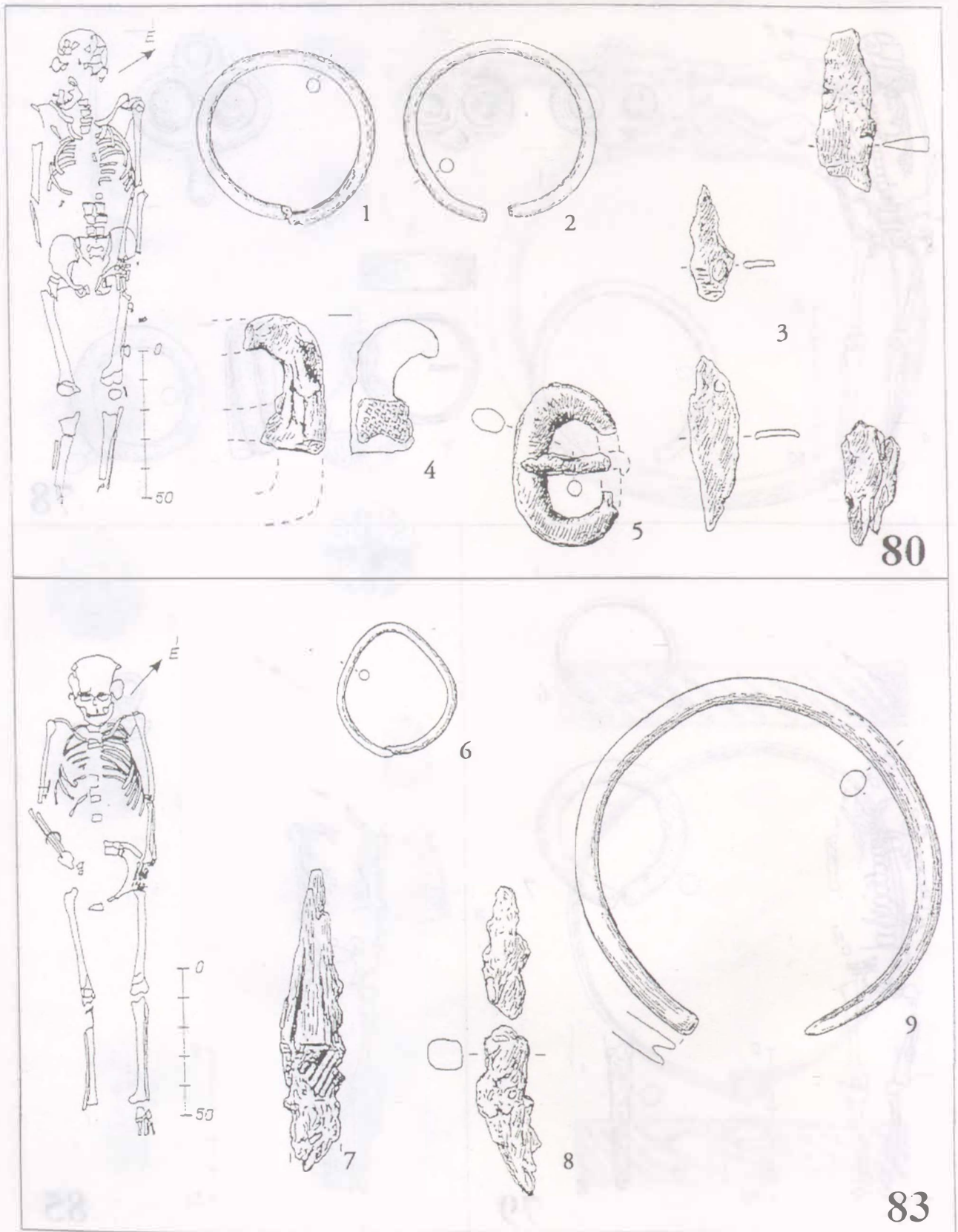

40. tábla: Hajdúszoboszló-Árkoshalom. 80., 83. sír (1:1)

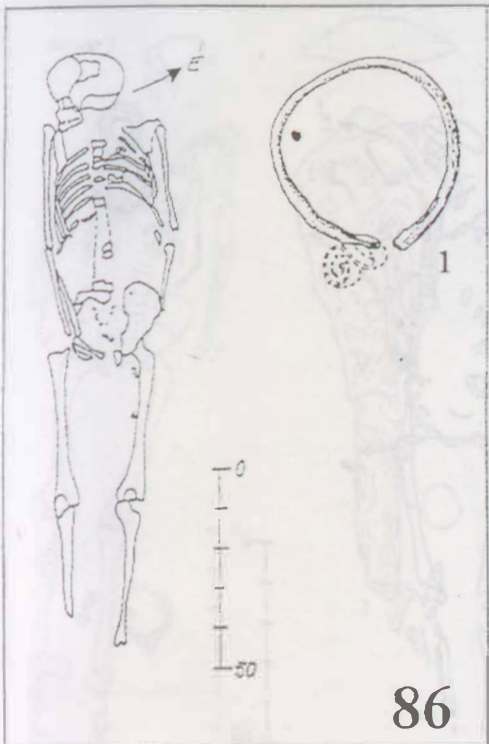

86

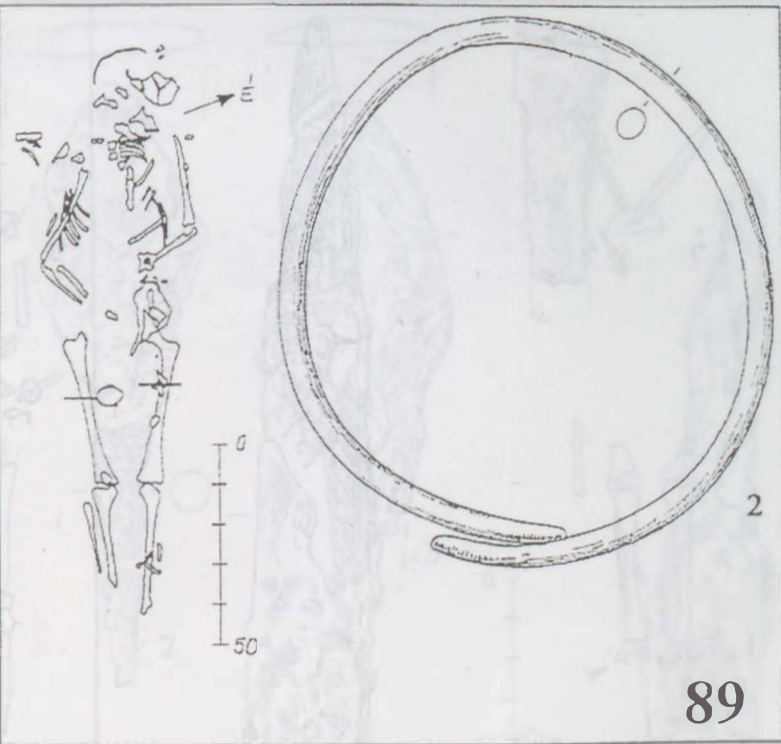

89

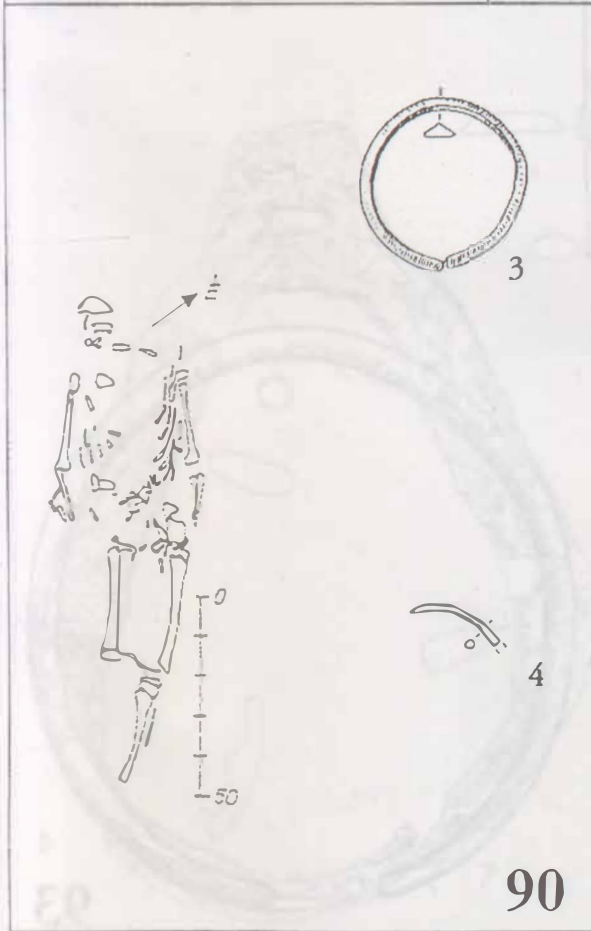

90

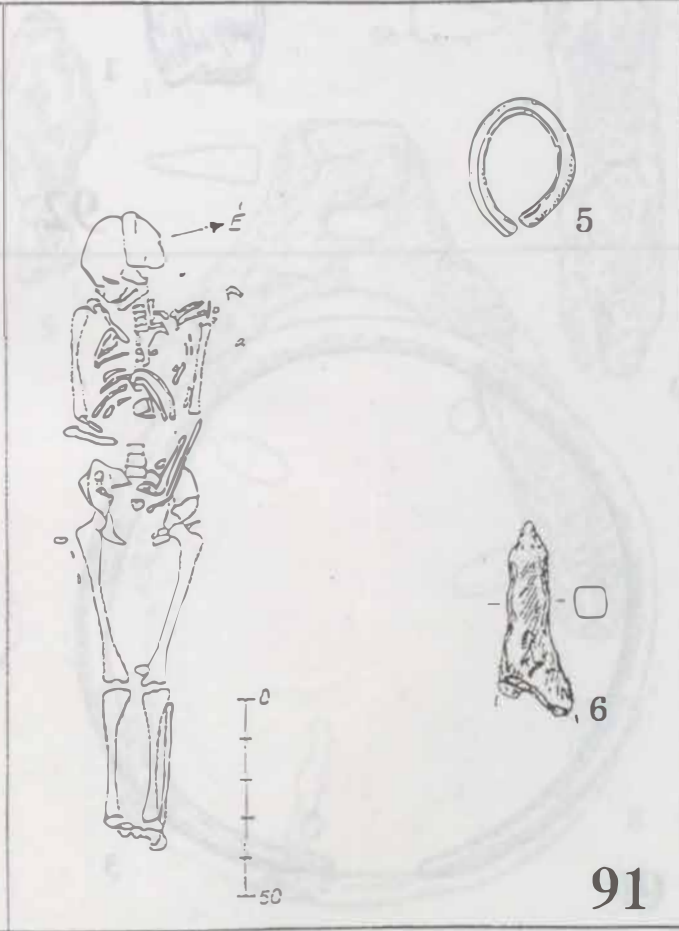

91

41. tábla: Hajdúszoboszló-Árkoshalom. 86., 89–91. sír (1:1)

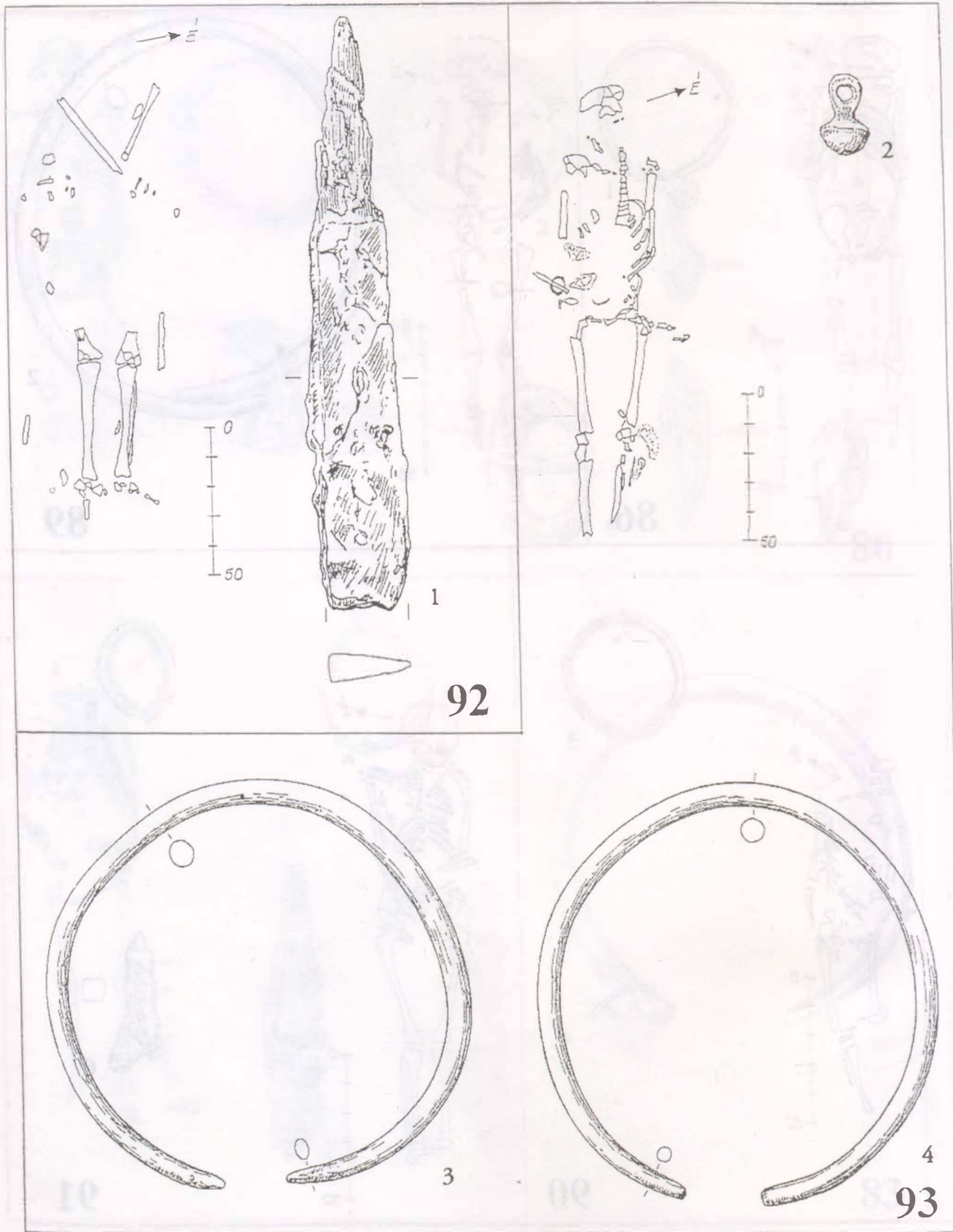

42. tábla: Hajdúszoboszló-Árkoshalom. 92.-93. sír (1:1)

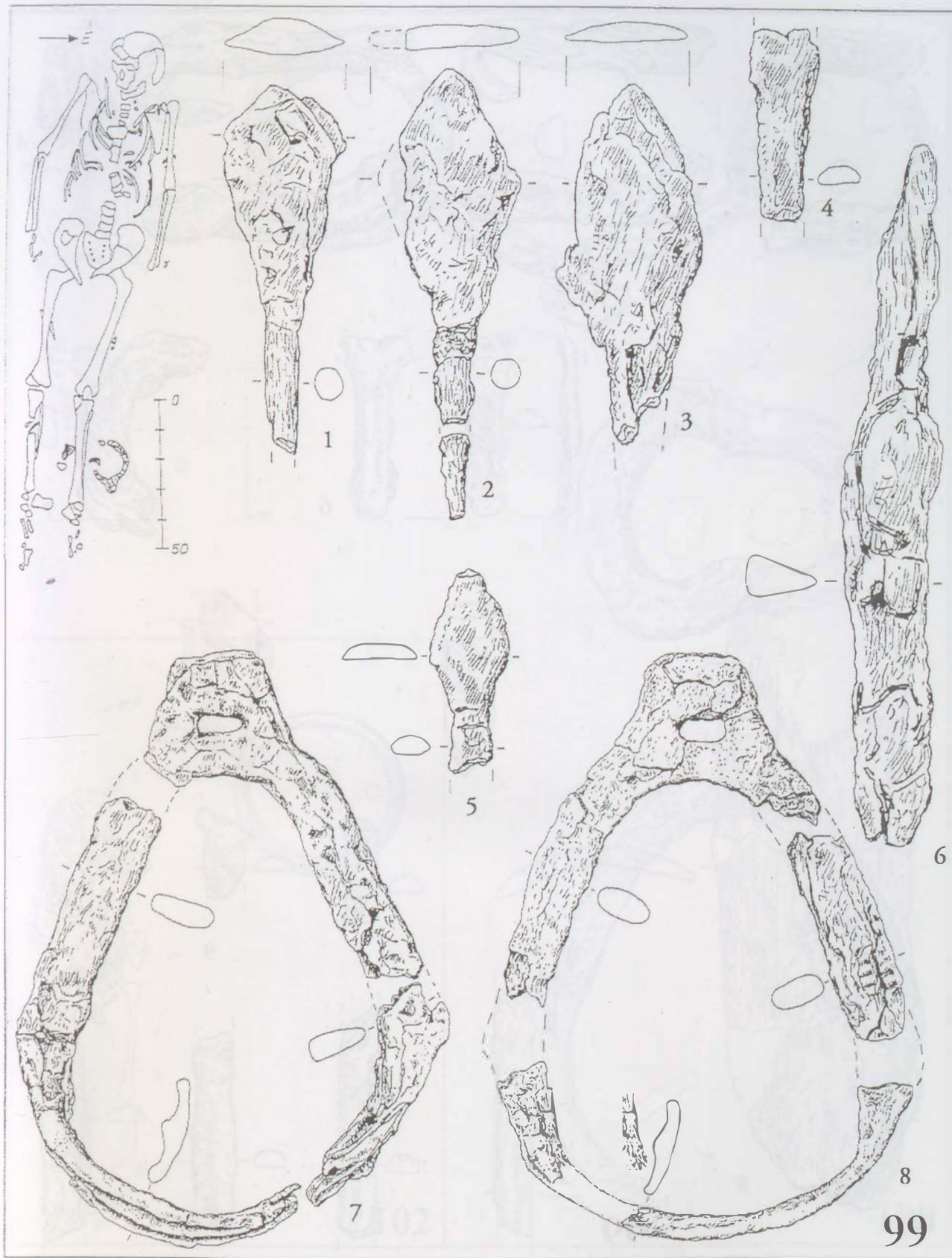

43. tábla: Hajdúszoboszló-Árkoshalom. 99. sír (1-6. 1:1; 7-8. 1:2)

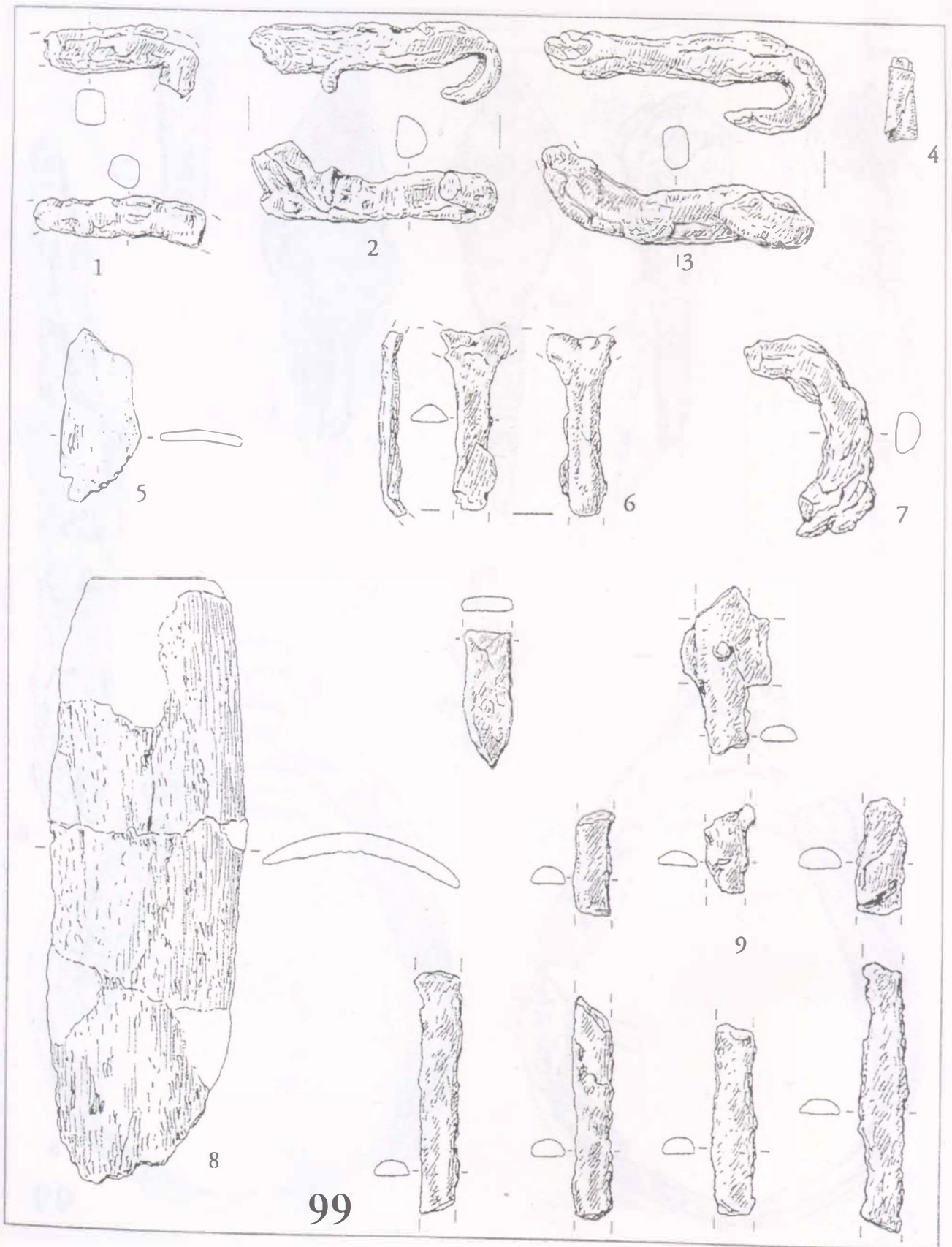

44. tábla: Hajdúszoboszló-Árkoshalom. 99. sír (1:1)

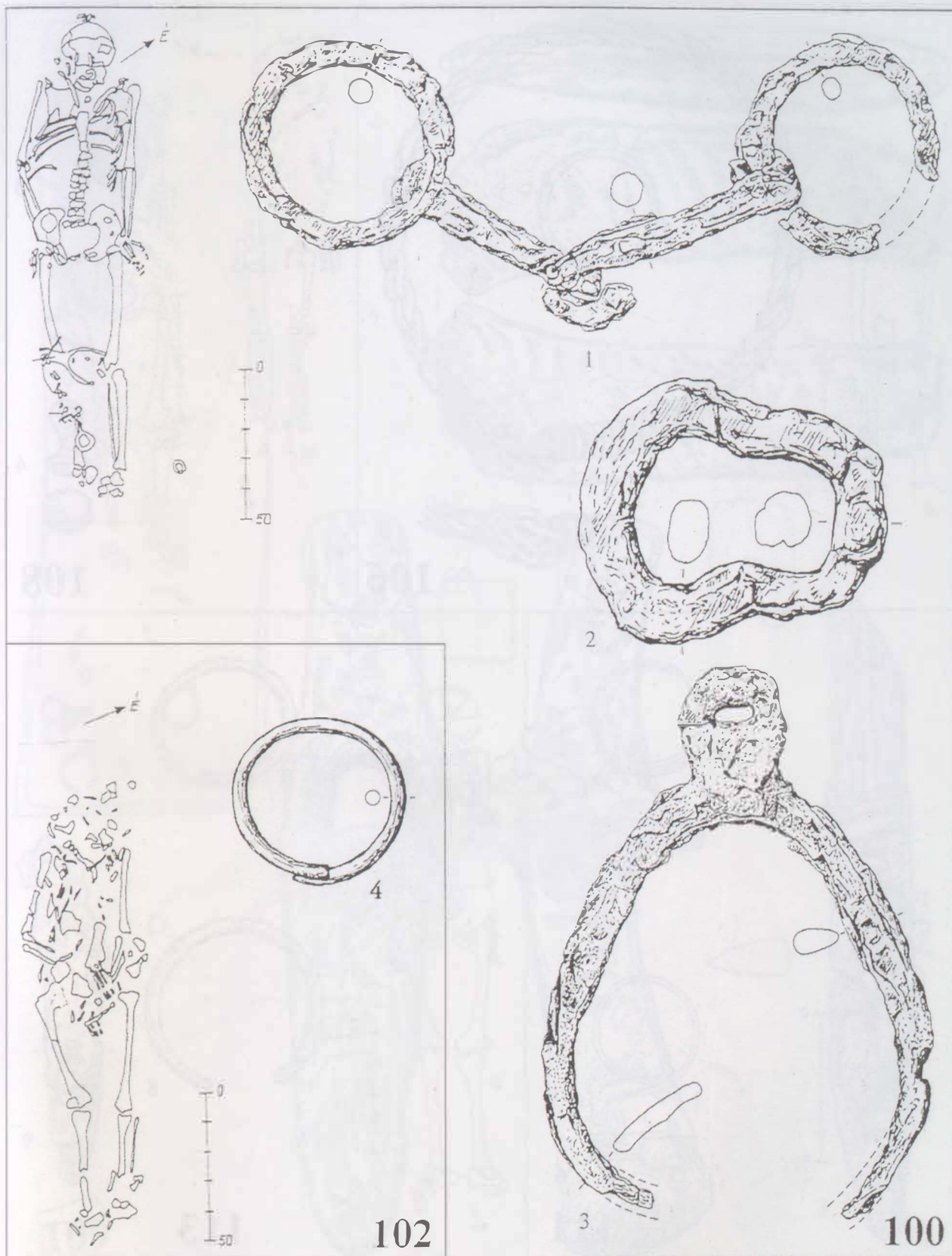

45. tábla: Hajdúszoboszló-Árkoshalom. 100. sír (1., 3. 1:2; 2. 1:1) 102. sír (1:1)

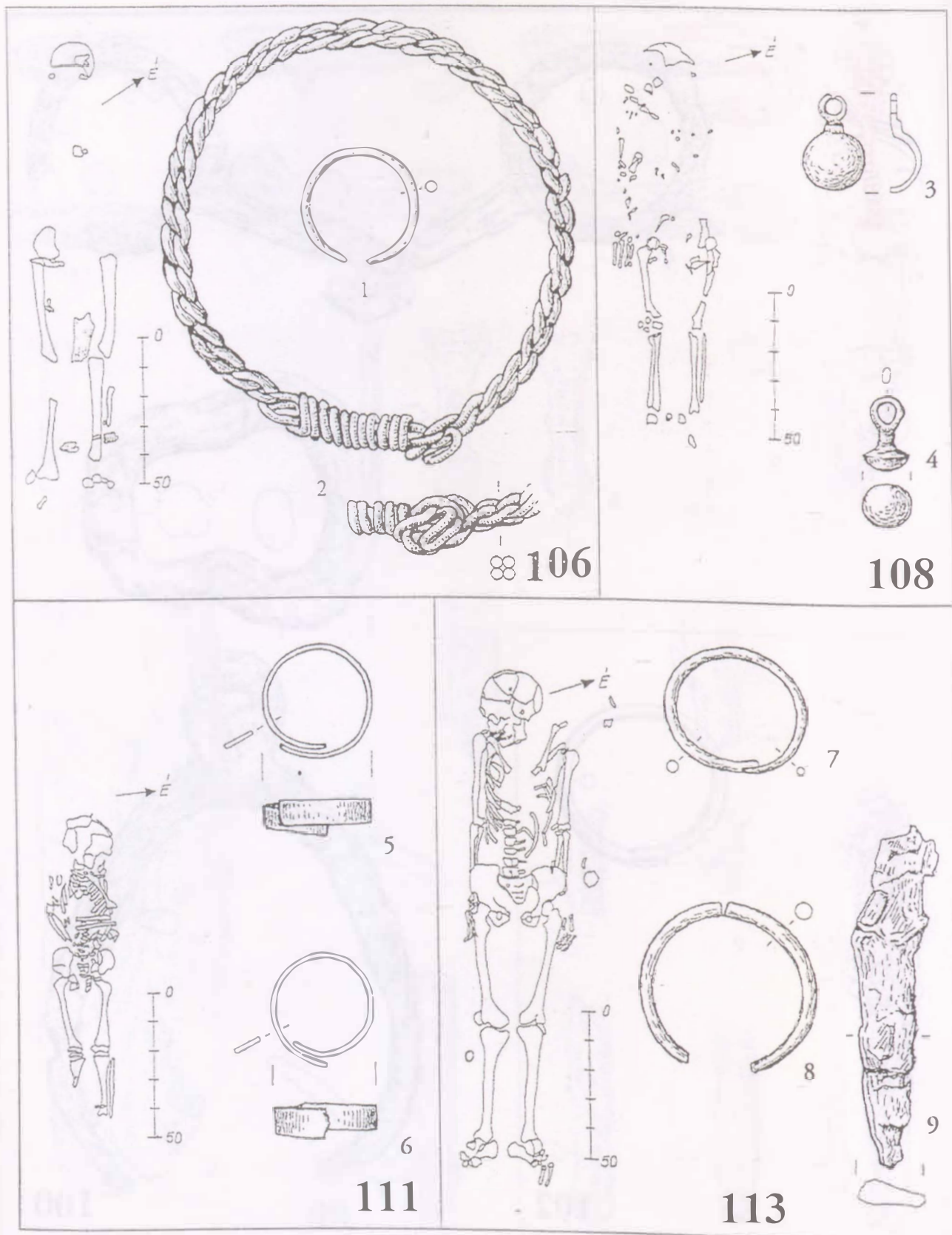

46. tábla: Hajdúszoboszló-Árkoshalom. 106., 108., 111., 113. sír (1:1)

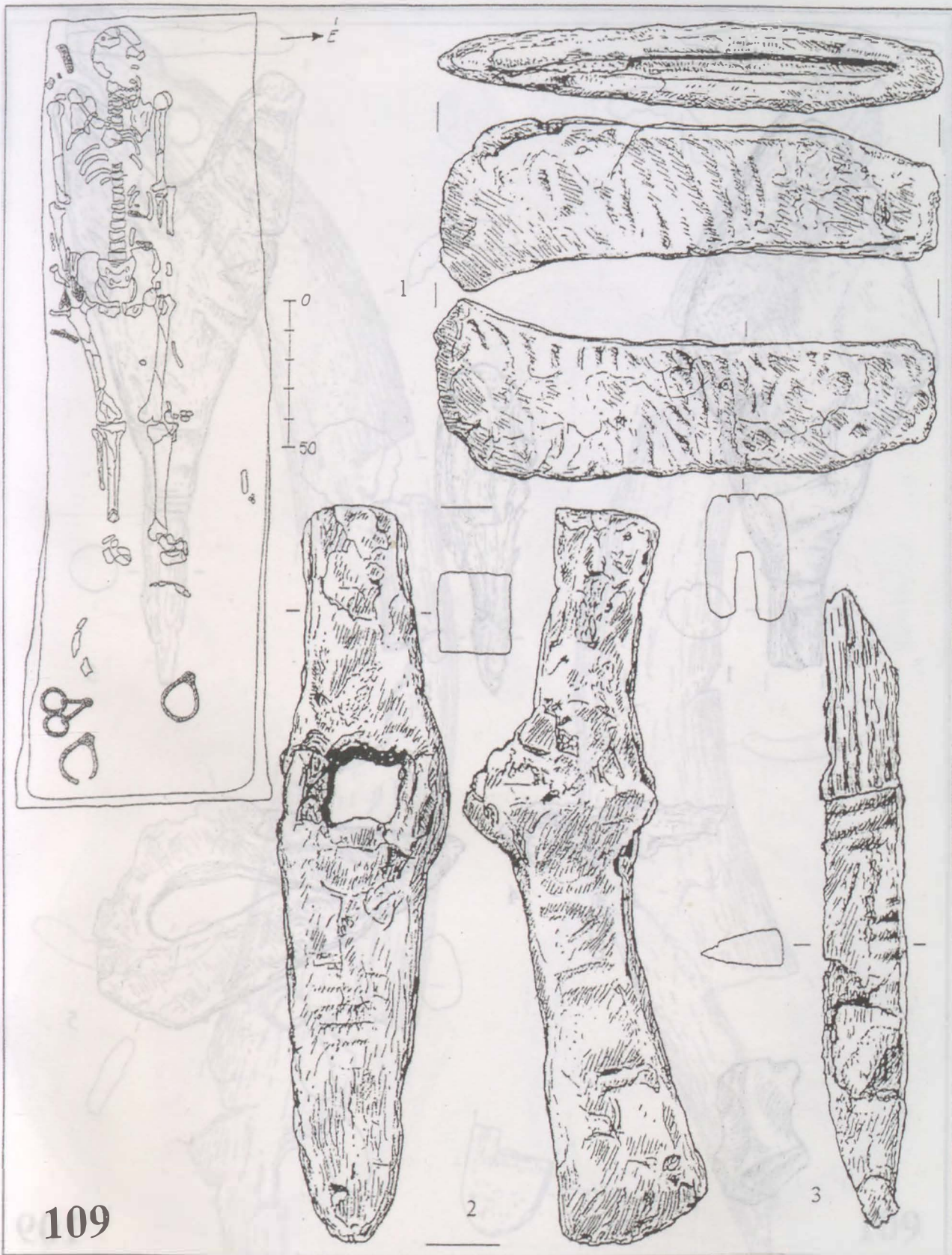

47. tábla: Hajdúszoboszló-Árkoshalom: 109. sír (1:1)

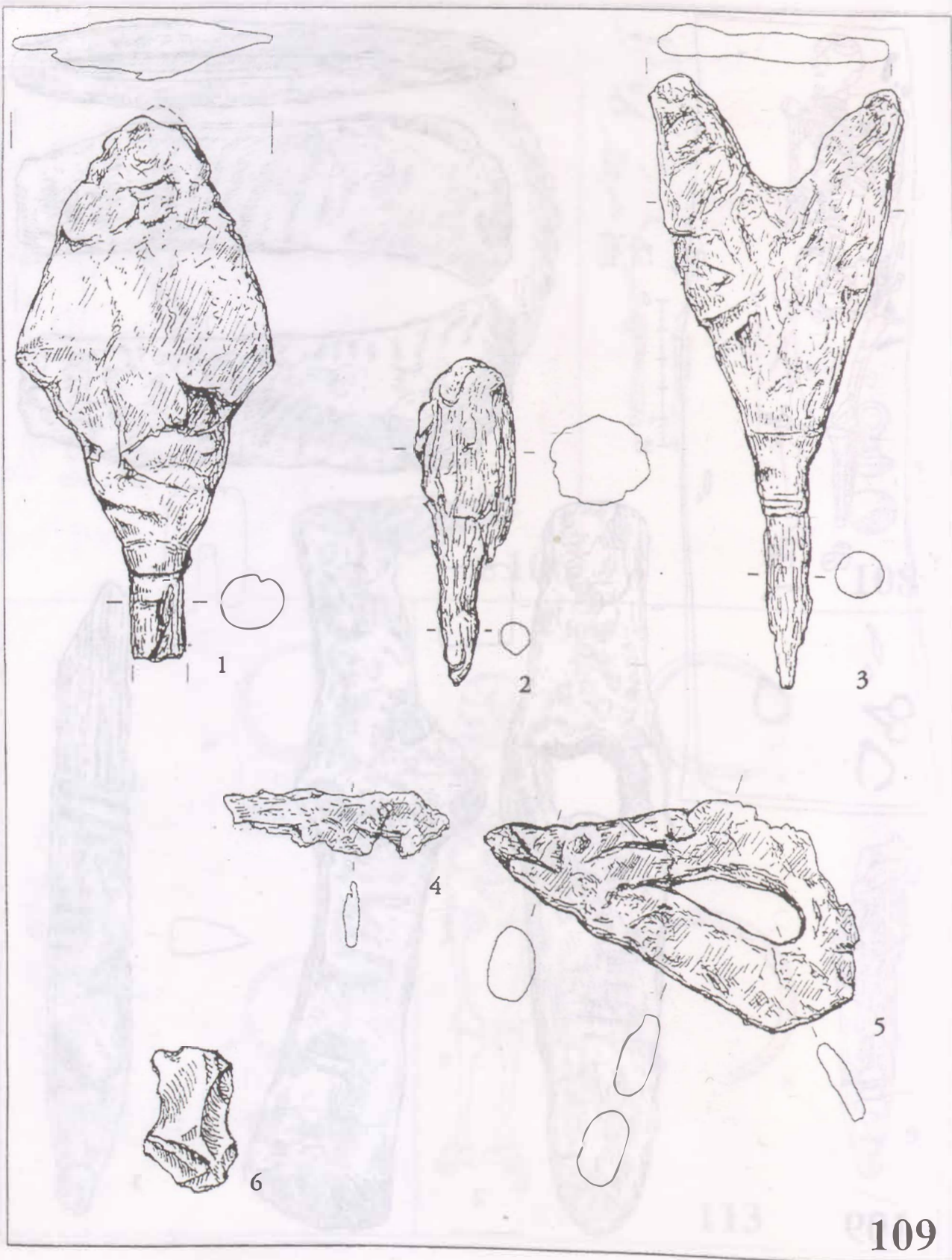

109

48. tábla: Hajdúszoboszló-Árkoshalom. 109. sír (1:1)



49. tábla: Hajdúszoboszló-Árkoshalom. 109. sír (1:1)

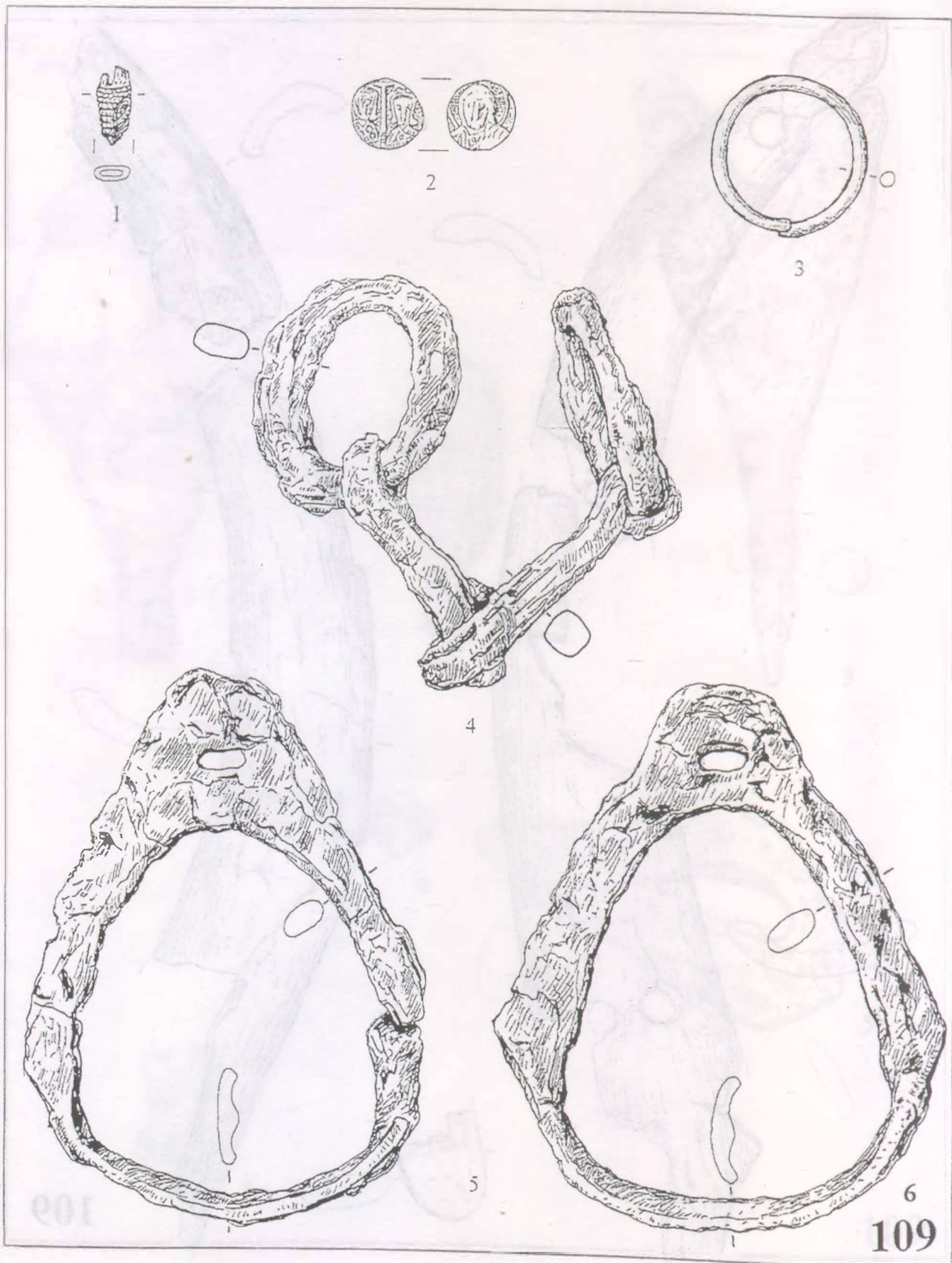

50. tábla: Hajdúszoboszló-Árkoshalom. 109. sír (1-3. 1:1; 4-6. 1:2)

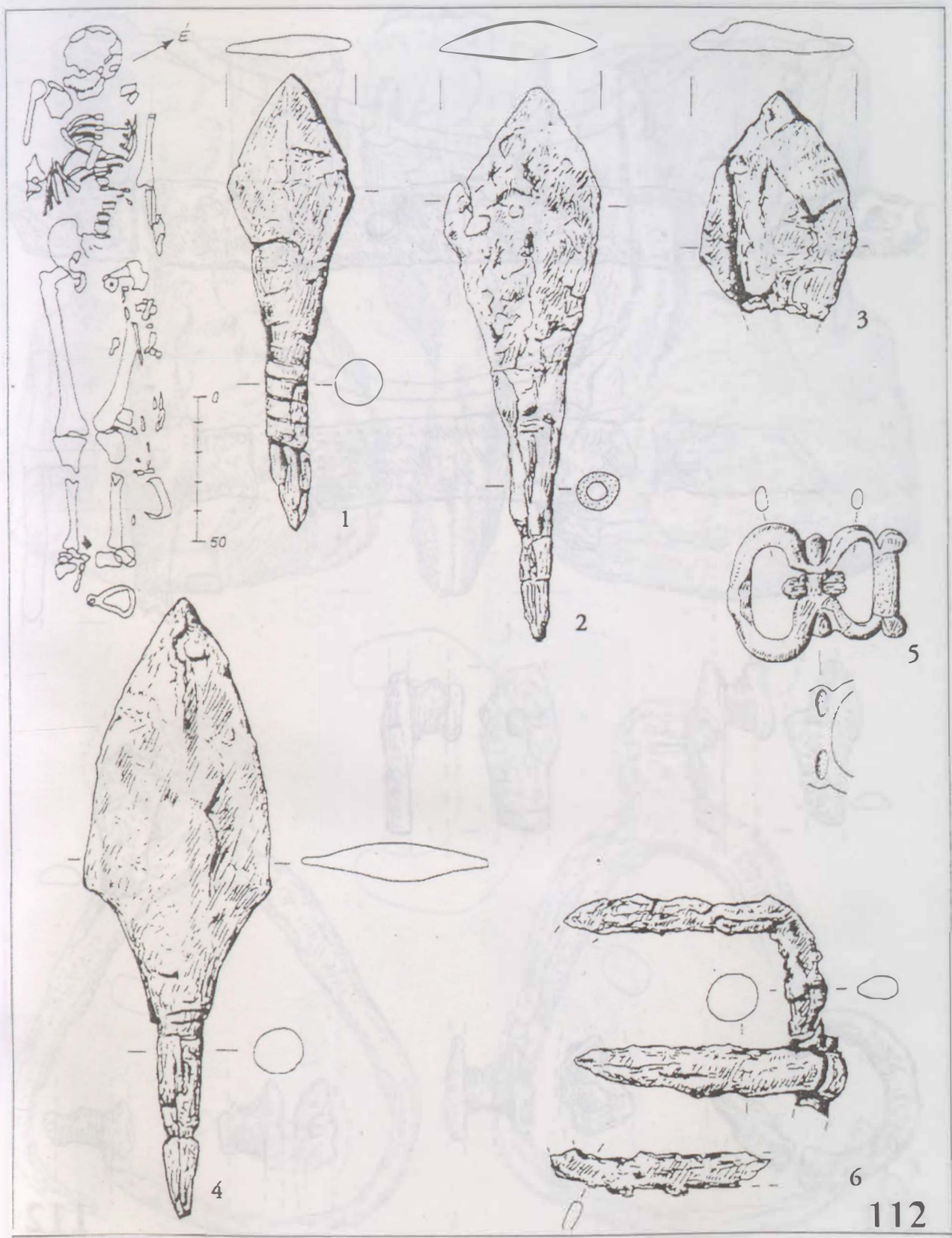

51. tábla: Hajdúszoboszló-Árkoshalom. 112. sír (1:1)

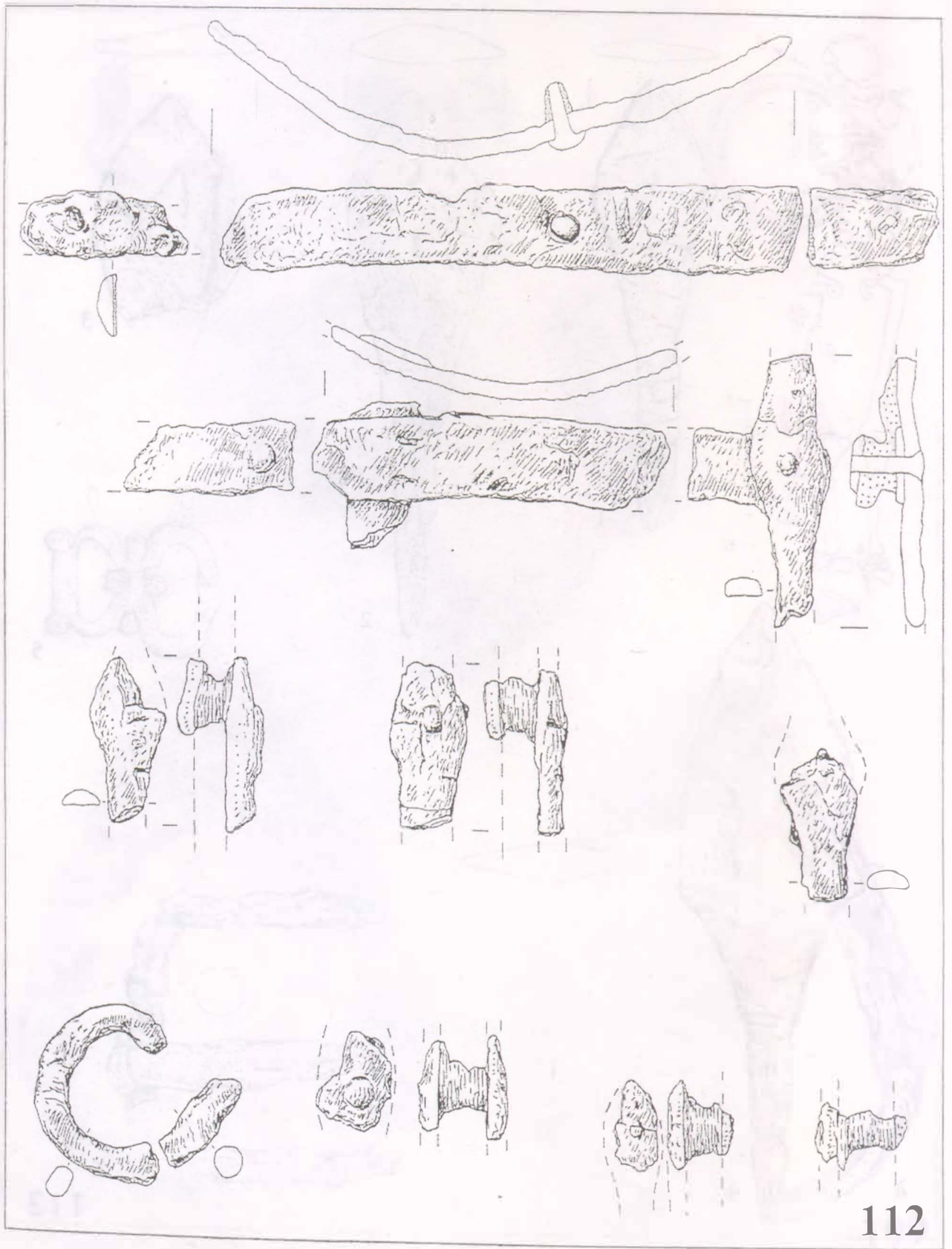

112

52. tábla: Hajdúszoboszló-Árkoshalom. 112. sír (1:1)

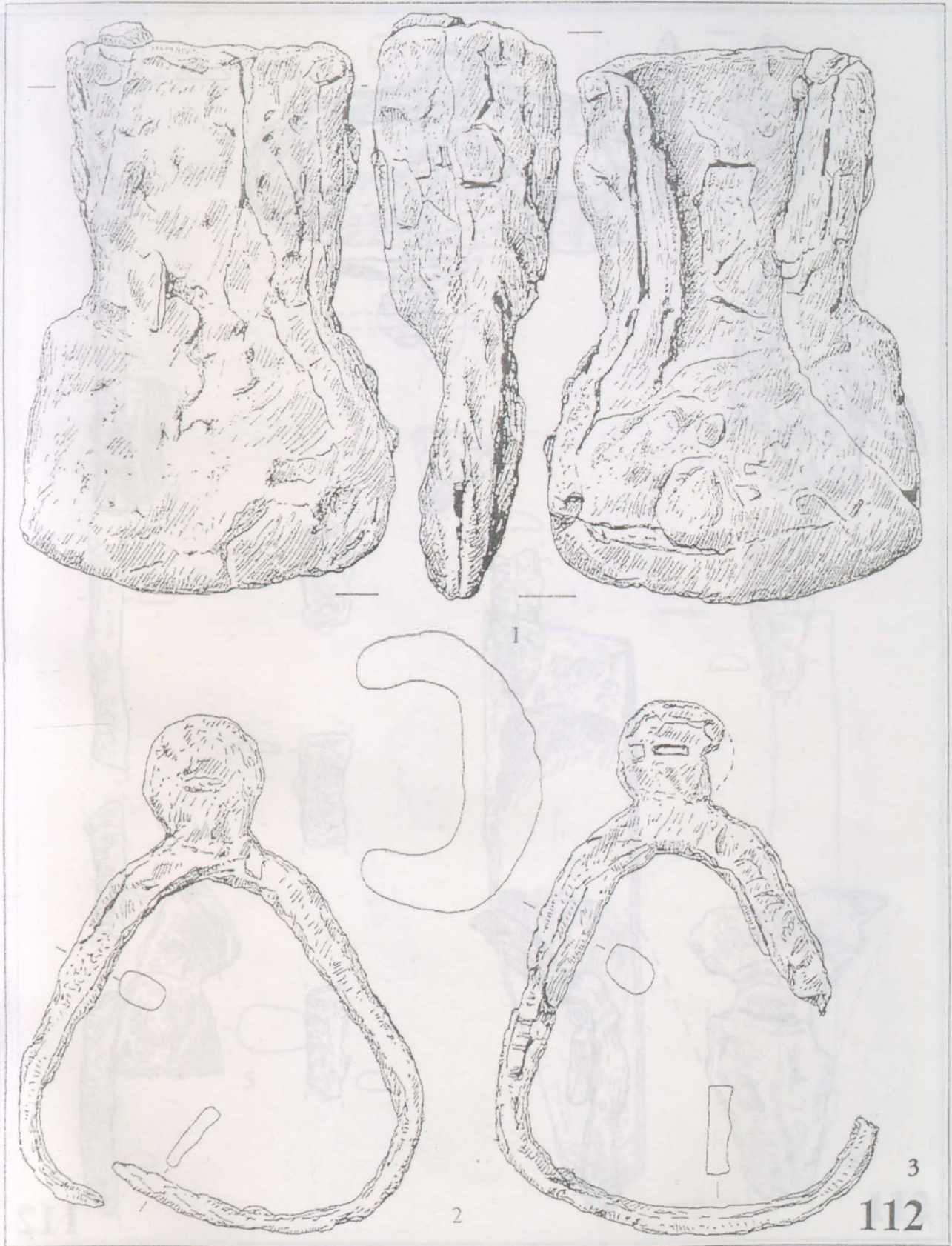

53. tábla: Hajdúszoboszló-Árkoshalom. 112. sír (1. 1:1; 2-3. 1:2)

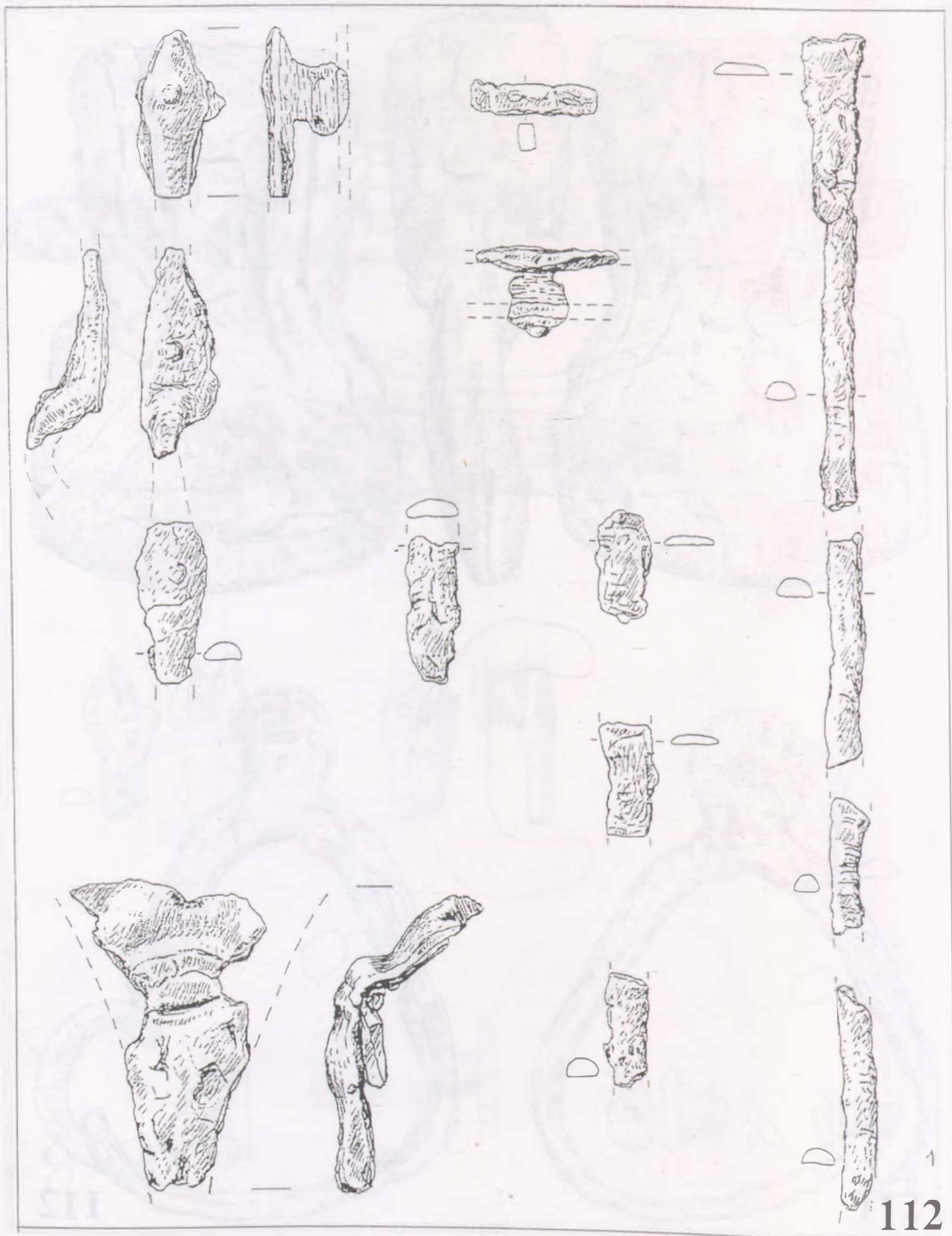

54. tábla: Hajdúszoboszló-Árkoshalom. 112. sír (1:1)

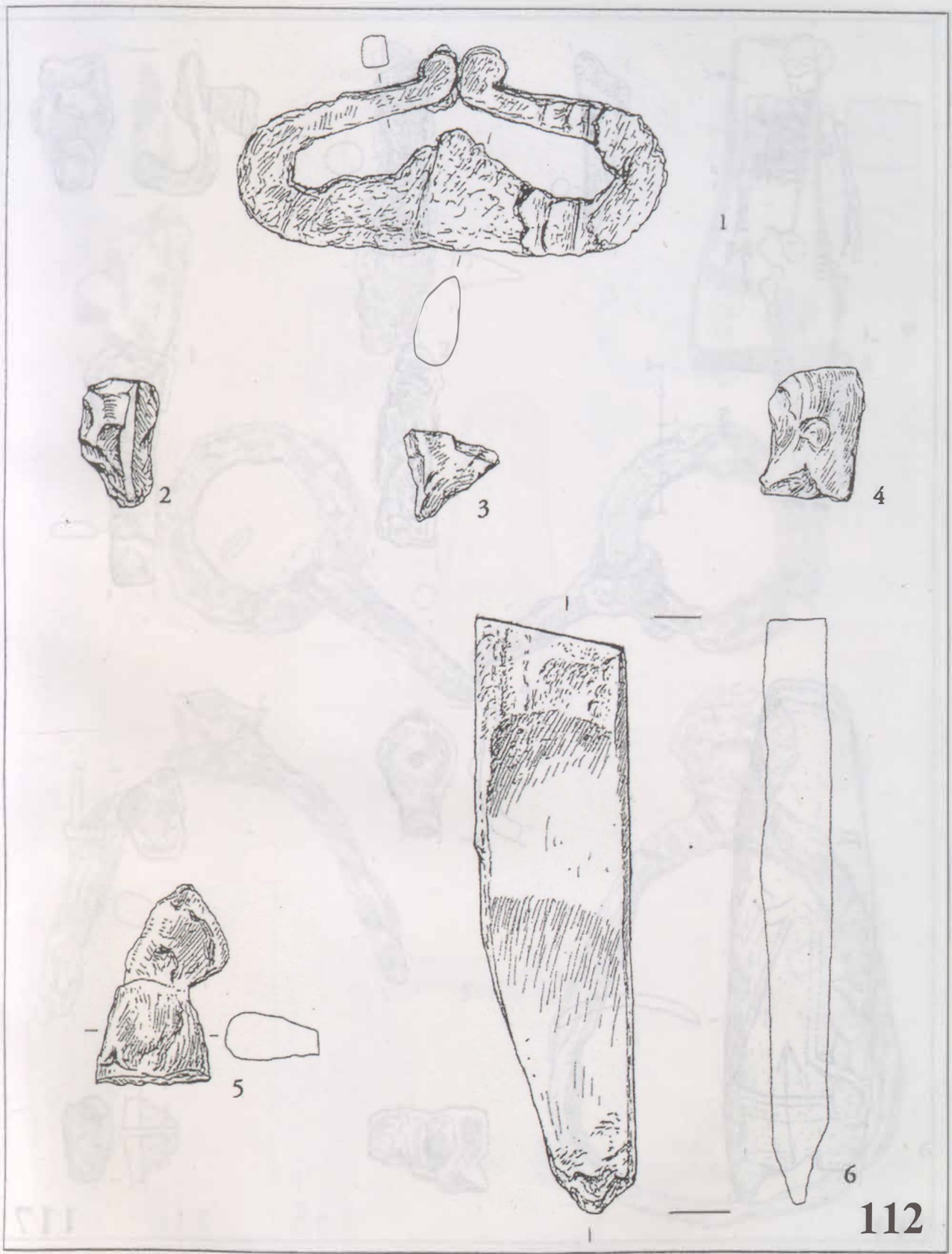

112

55. tábla: Hajdúszoboszló-Árkoshalom. 112. sír (1:1)

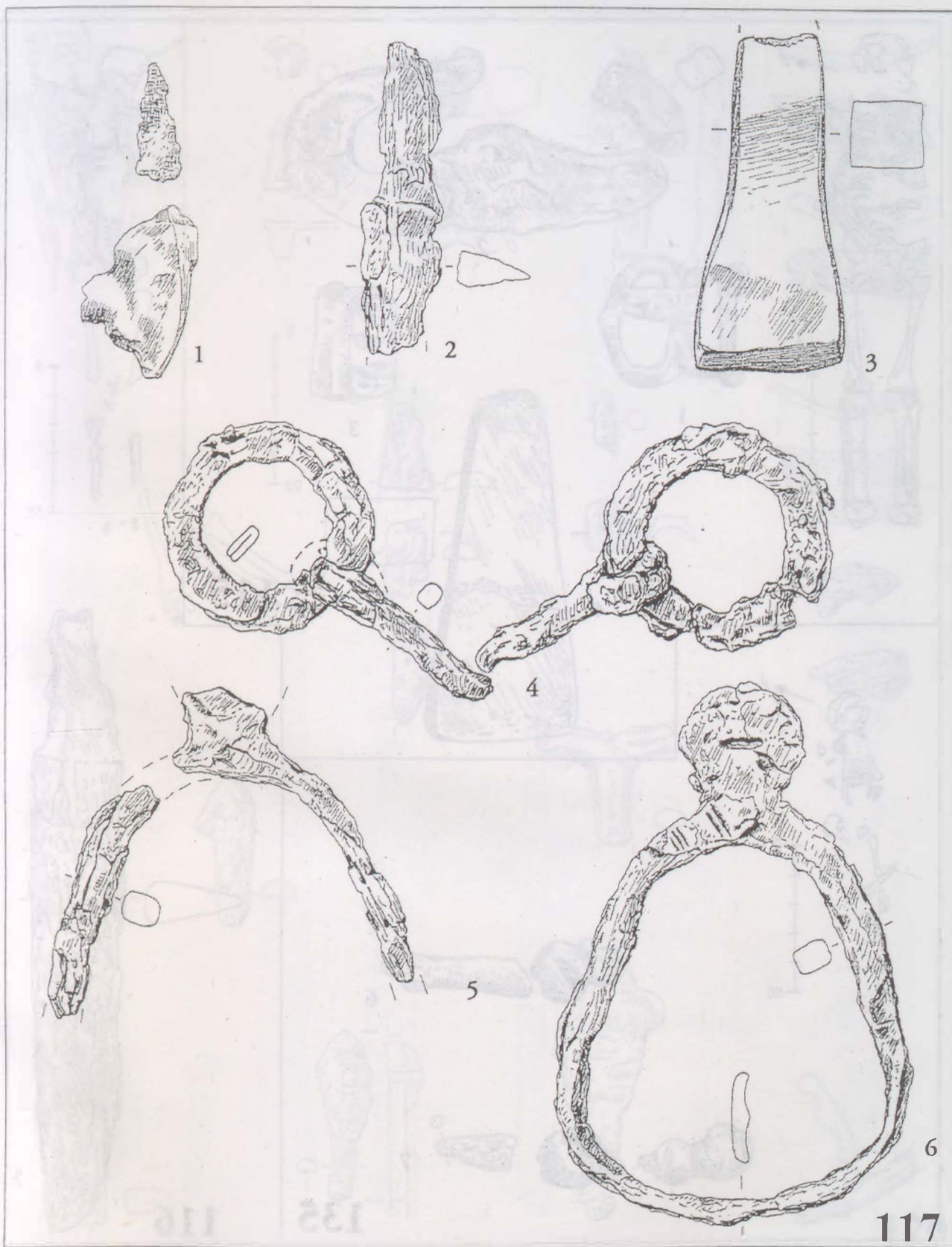

57. tábla: Hajdúszoboszló-Árkoshalom. 117. sír (1-3. 1:1; 4-6. 1:2)

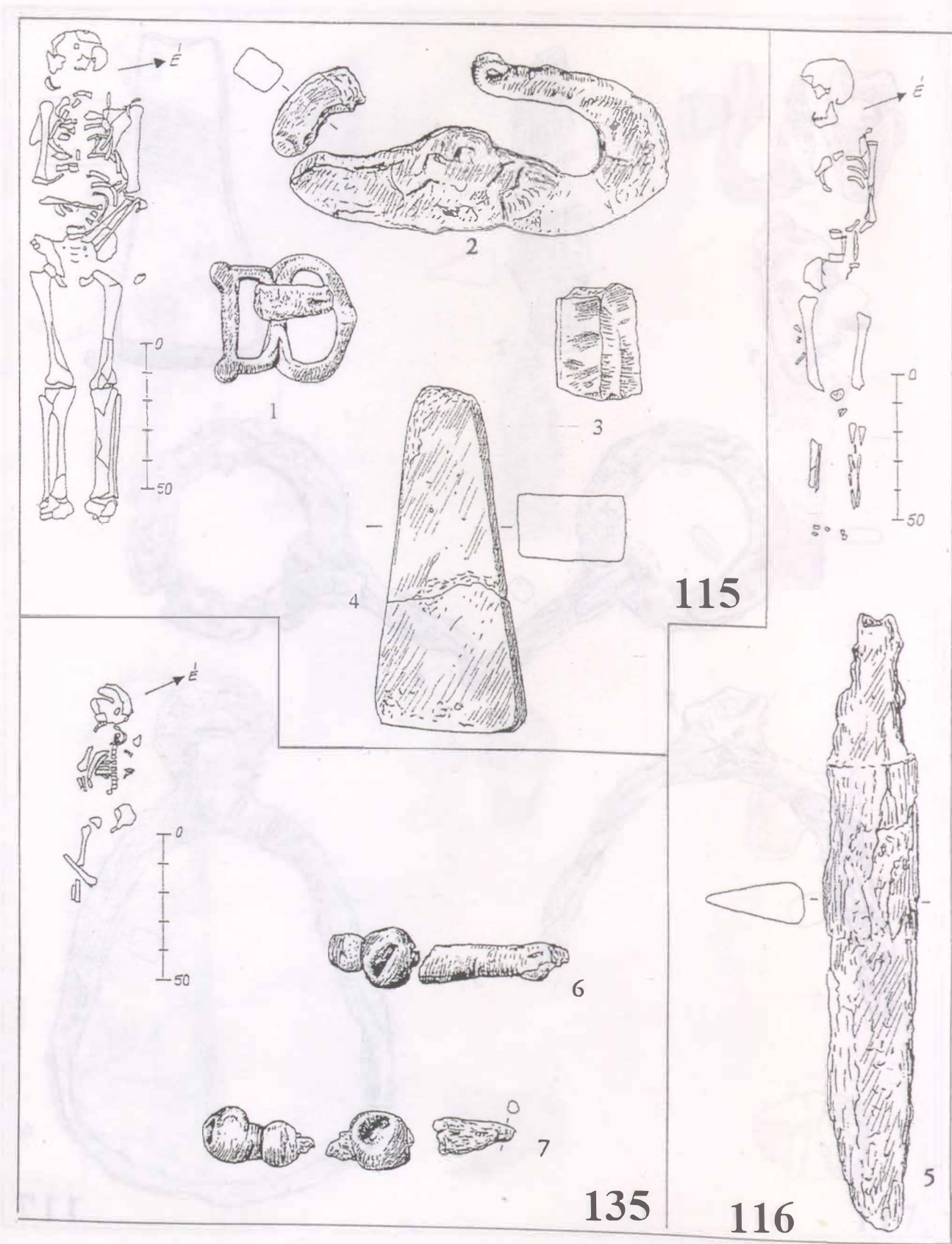

58. tábla: Hajdúszoboszló-Árkoshalom. 115–116., 135. sír (1:1)

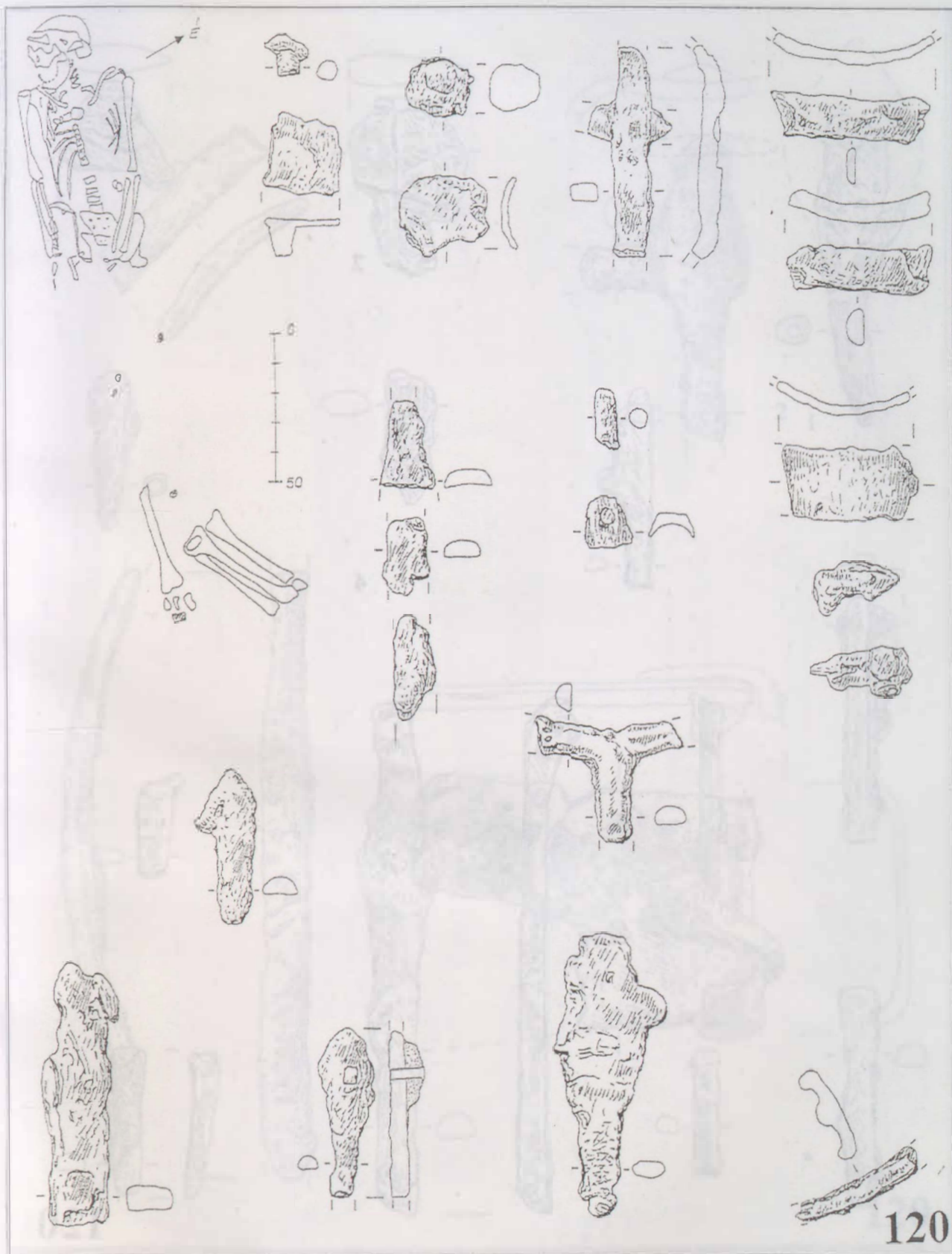

59. tábla: Hajdúszoboszló-Árkoshalom. 120. sír (1:1)

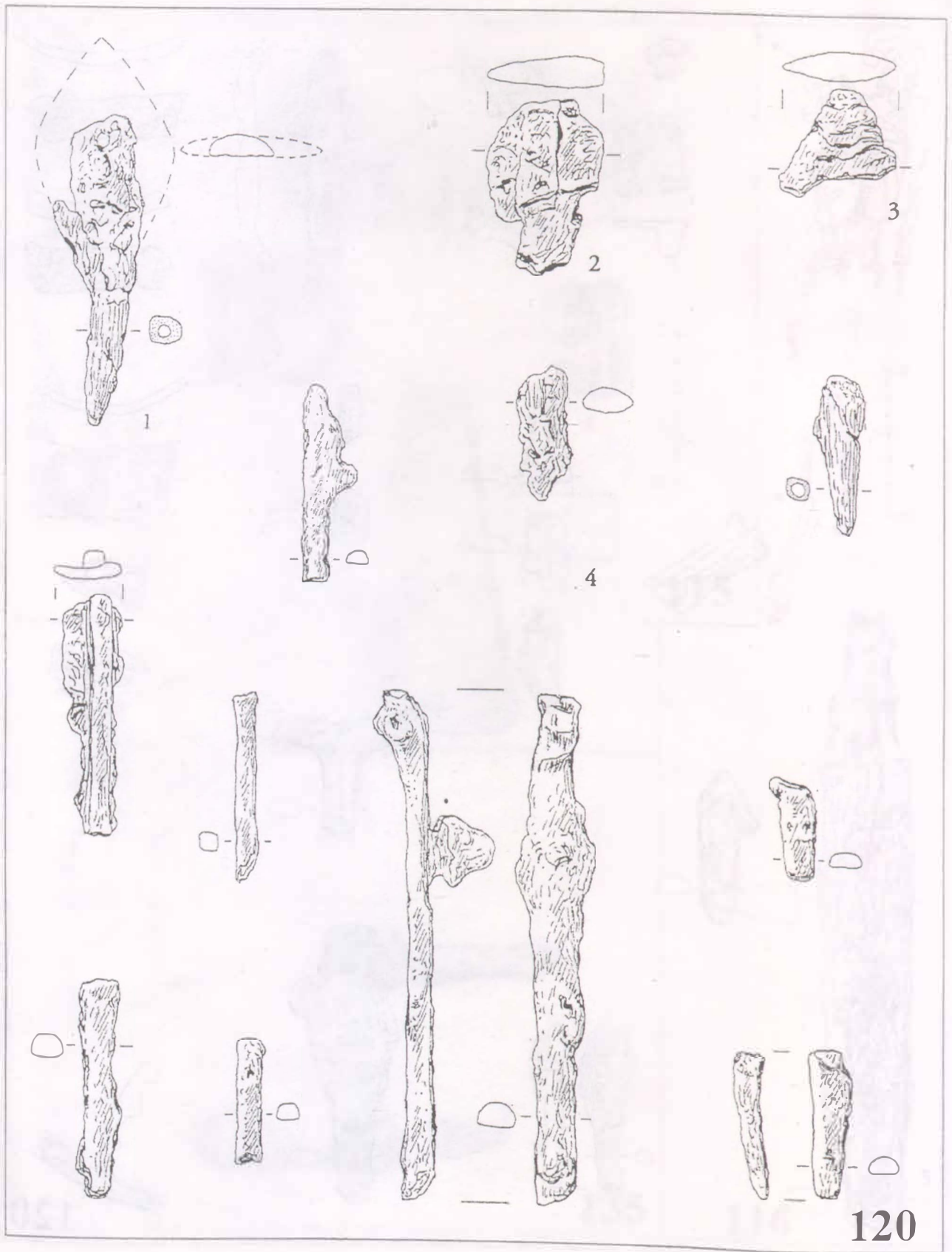

120

60. tábla: Hajdúszoboszló-Árkoshalom. 120. sír (1:1)

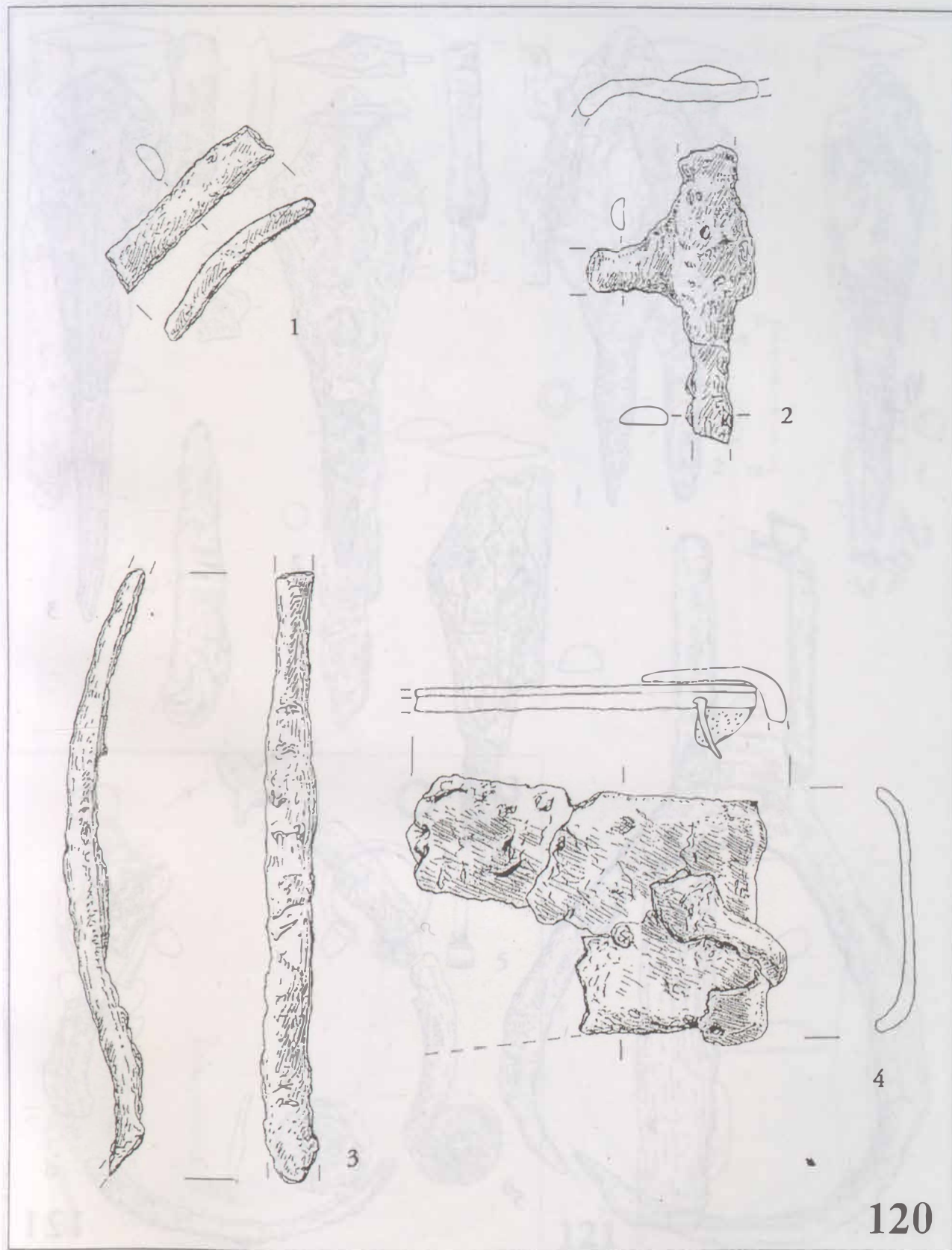

61. tábla: Hajdúszoboszló-Árkoshalom. 120. sír (1:1)

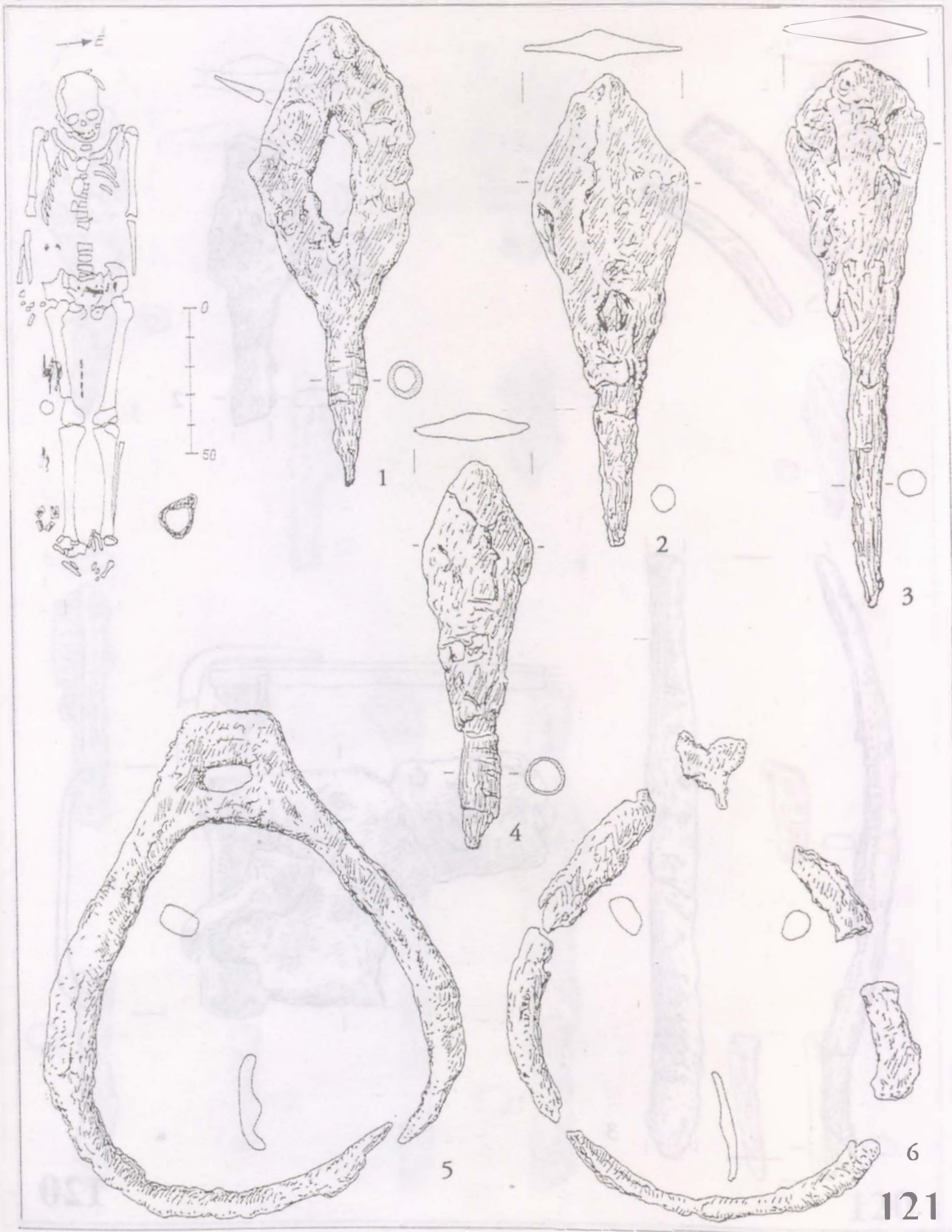

62. tábla: Hajdúszoboszló-Árkoshalom. 121. sír (1-4. 1:1; 5-6. 1:2)

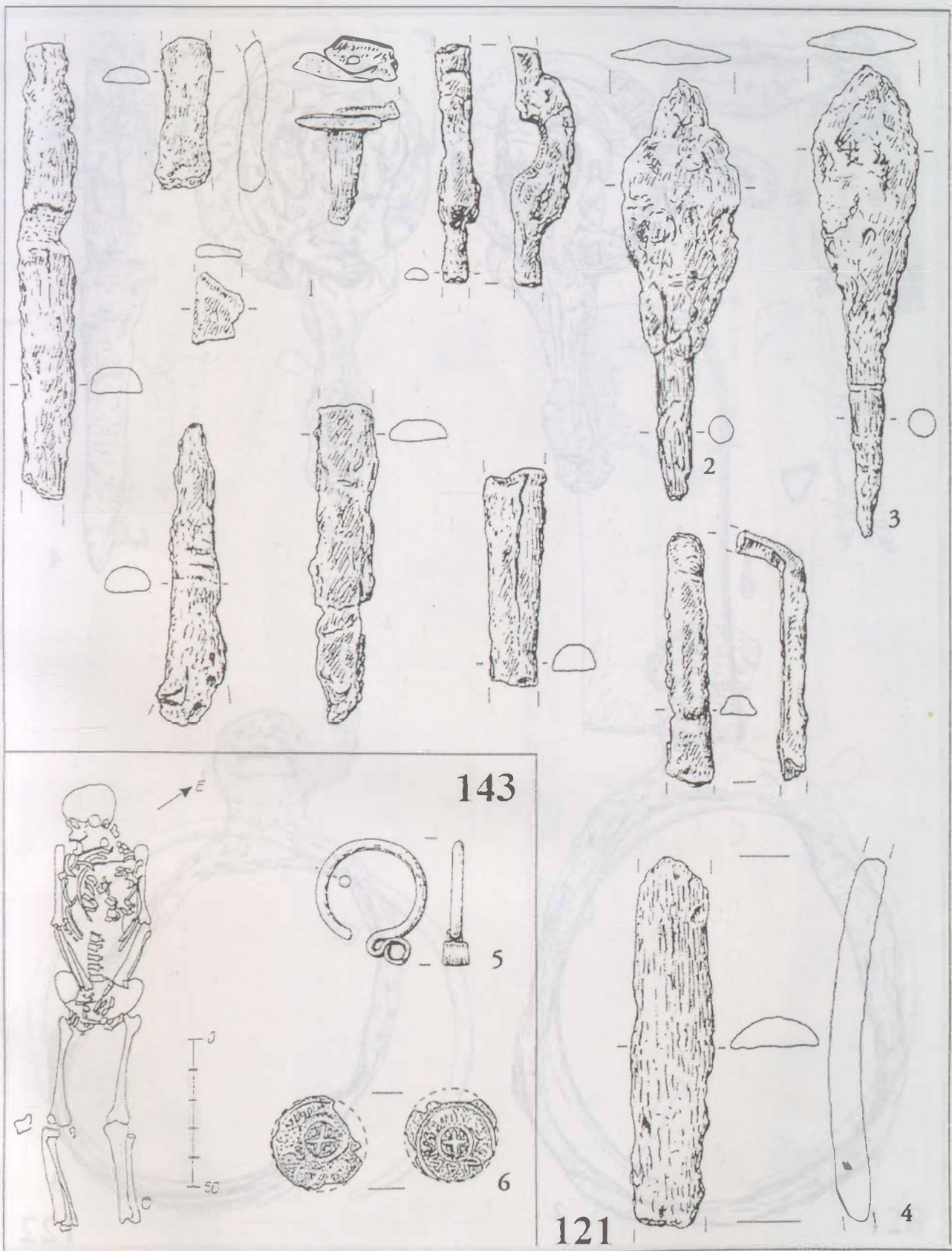

63. tábla: Hajdúszoboszló-Árkoshalom. 121., 143. sír (1:1)

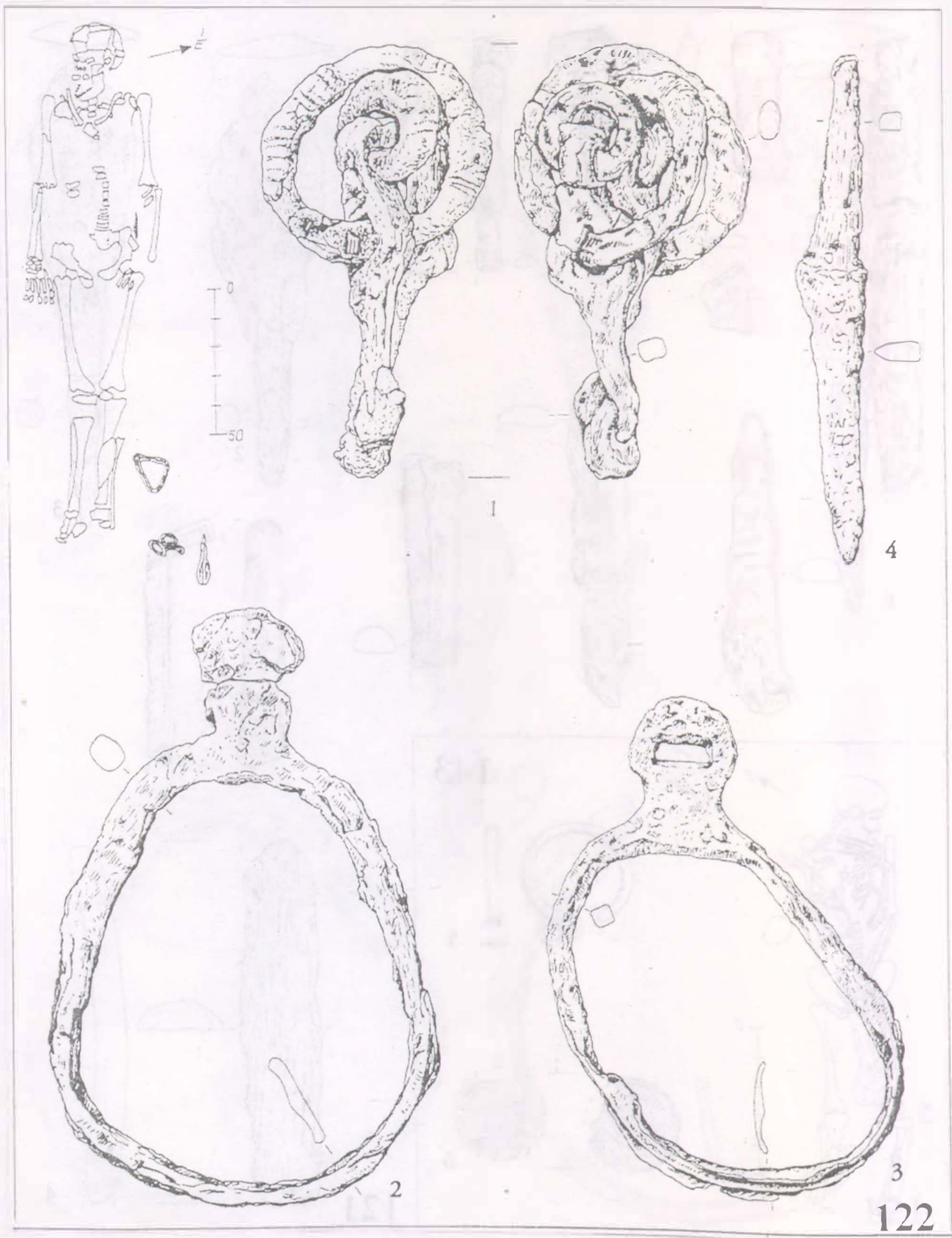

64. tábla: Hajdúszoboszló-Árkoshalom. 122. sír (3. 1:1; 1-2. 1:2)

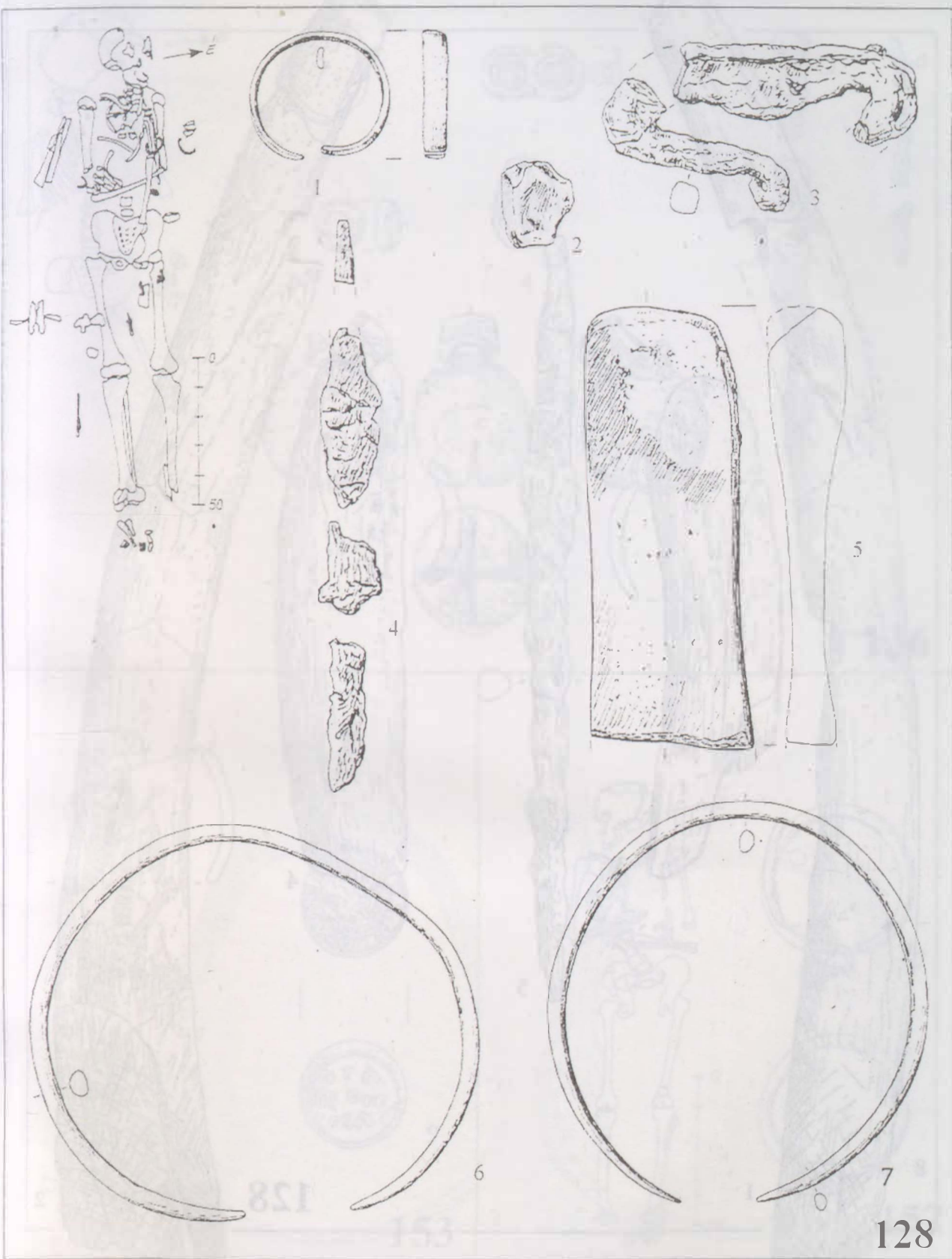

65. tábla: Hajdúszoboszló-Árkoshalom. 128. sír (1:1)

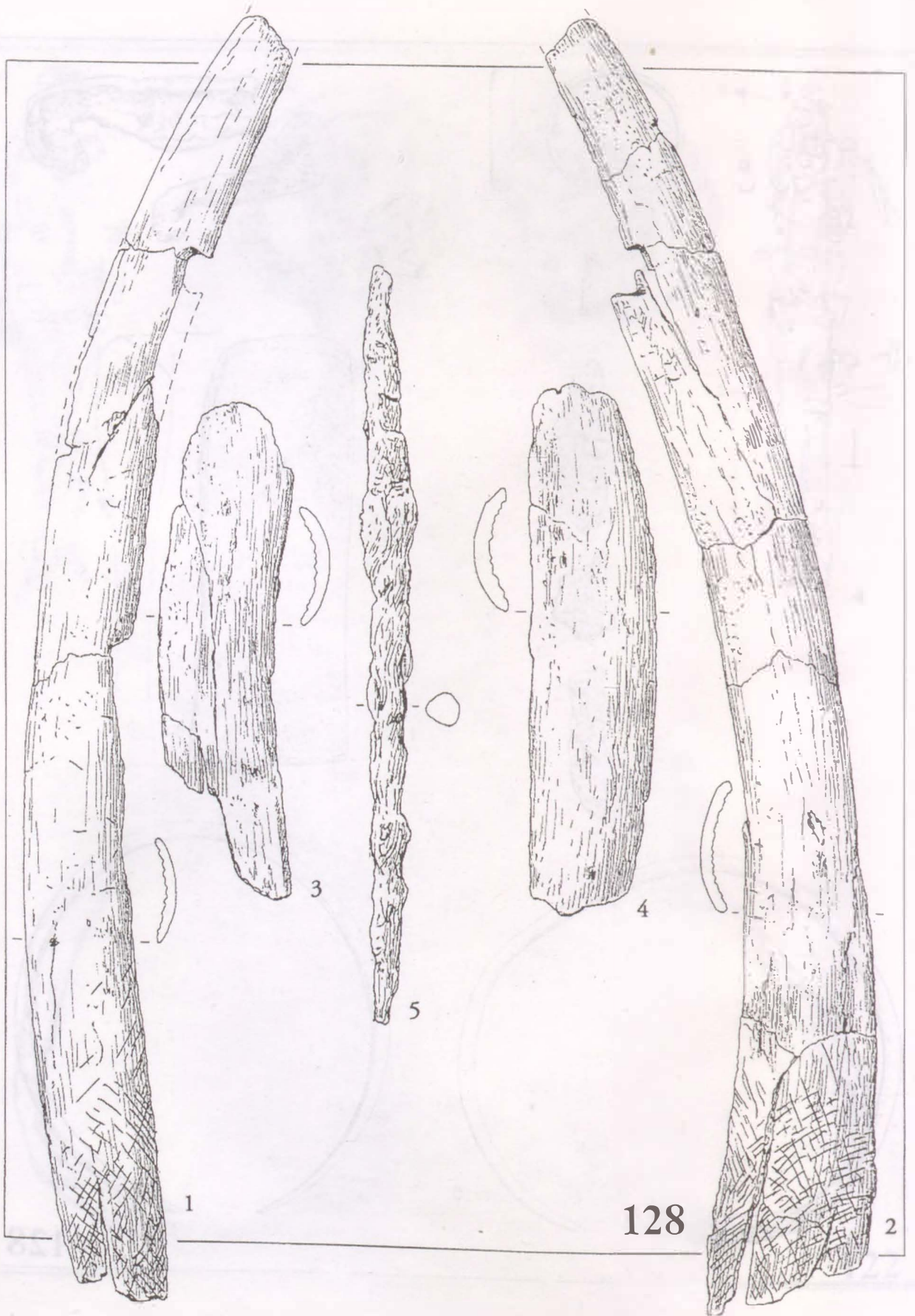

66. tábla: Hajdúszoboszló-Árkoshalom. 128. sír (1:1)

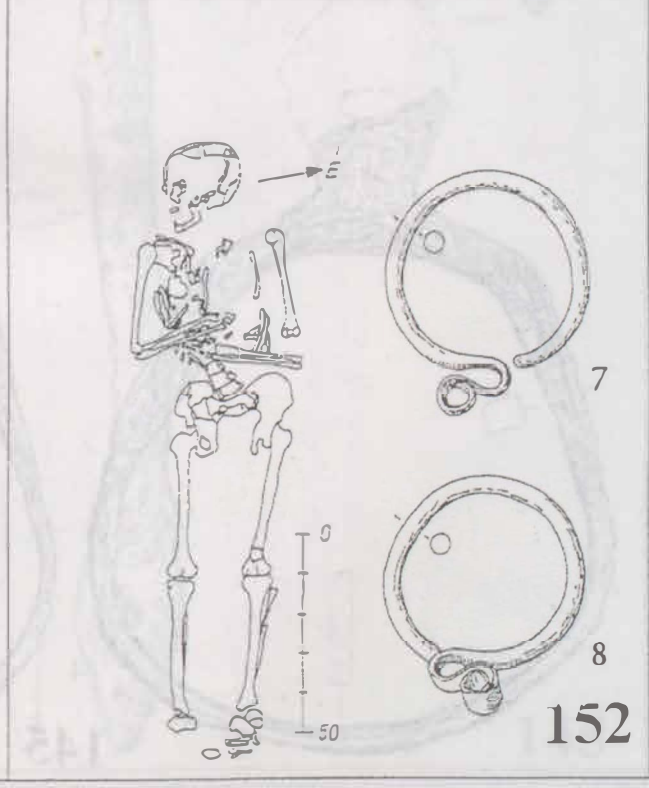
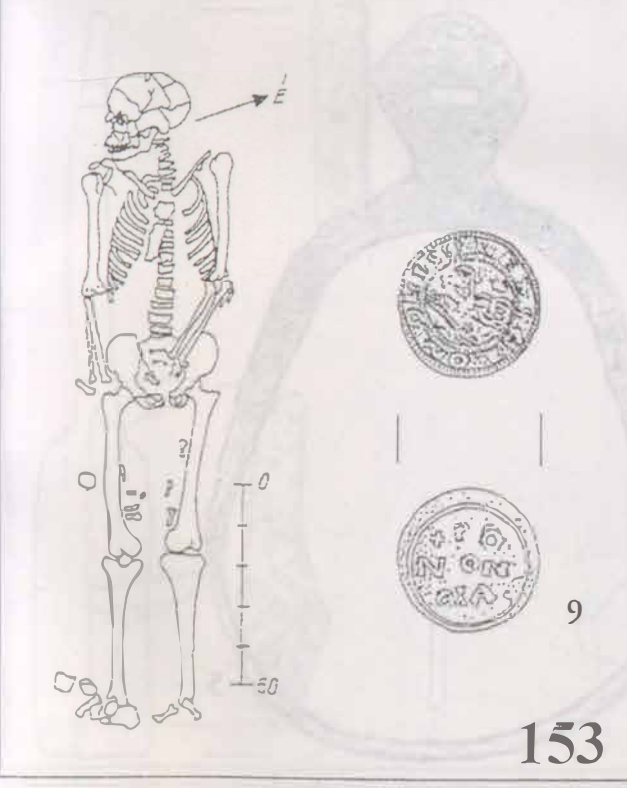
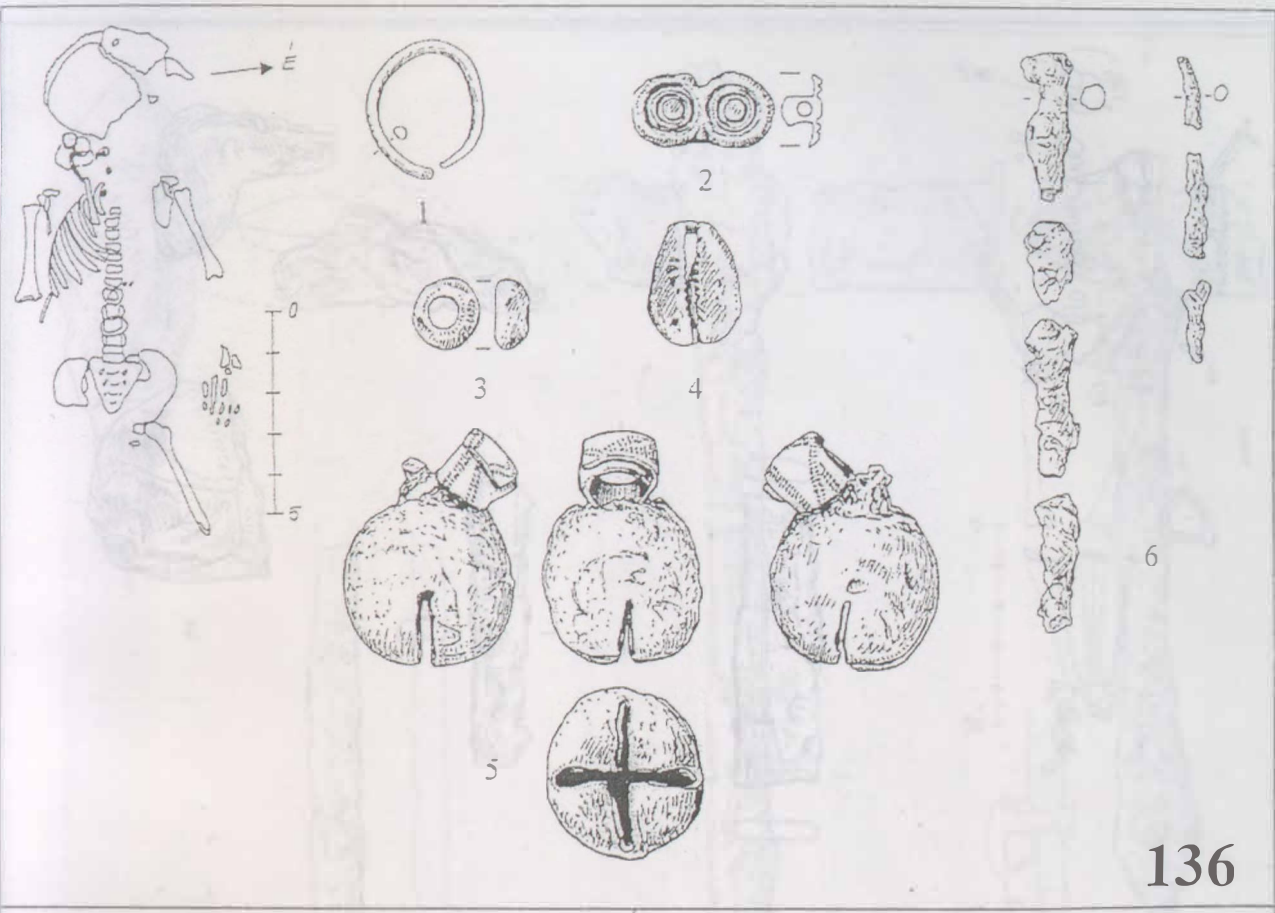

67. tábla: Hajdúszoboszló-Árkoshalom. 136., 152., 153. sír (1:1)

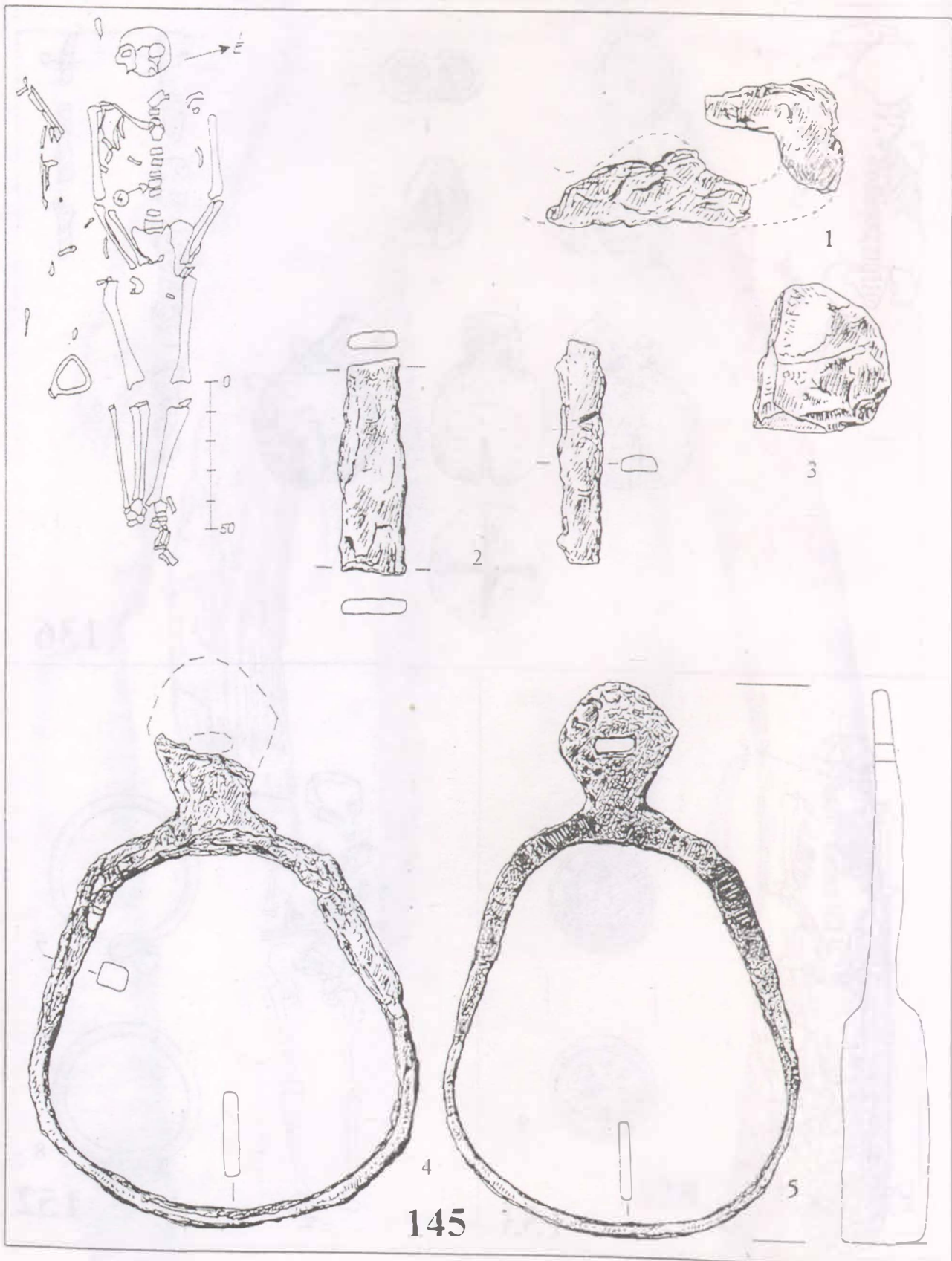

68. tábla: Hajdúszoboszló-Árkoshalom. 145. sír (1-3. 1:1; 4-5. 1:2)

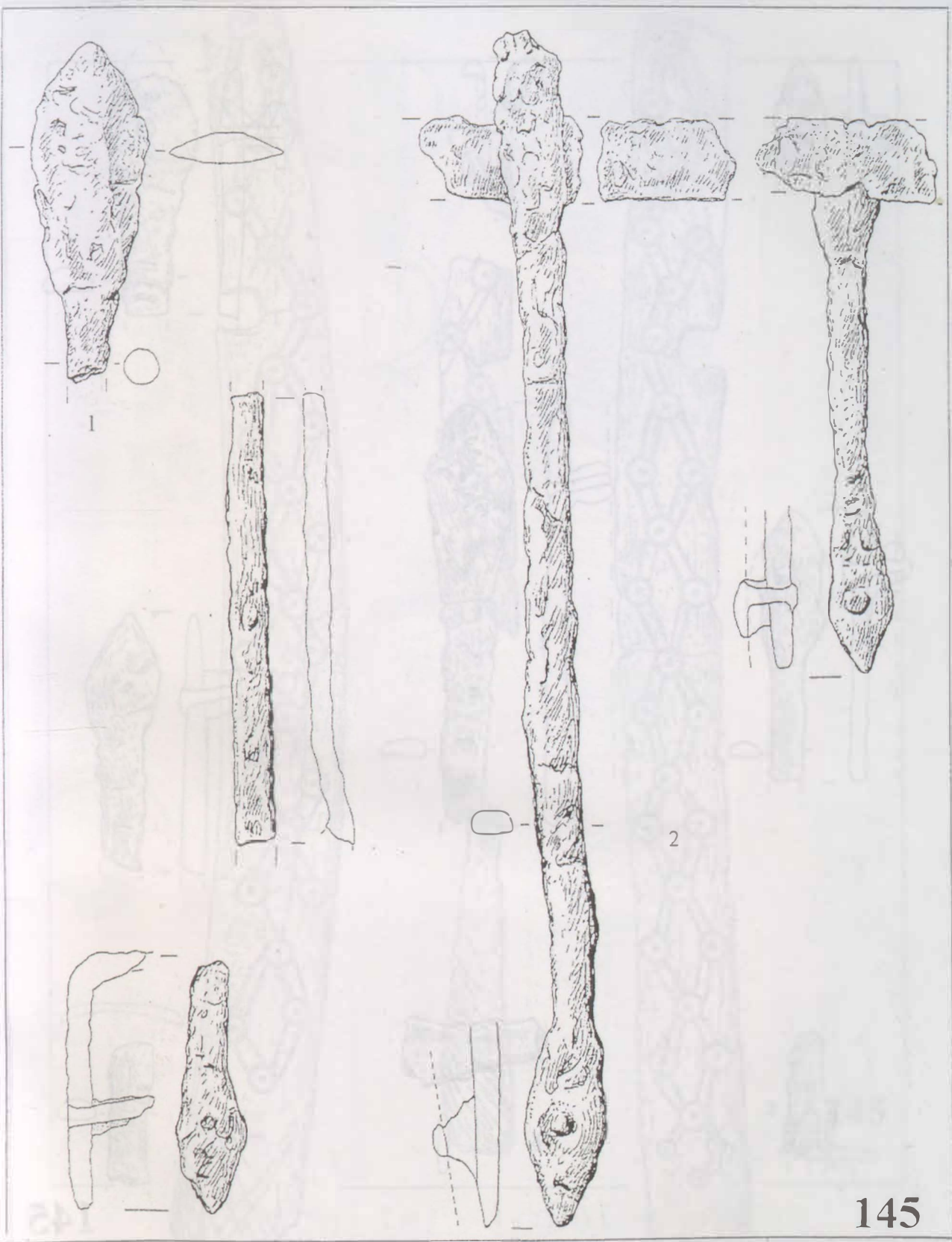

69. tábla: Hajdúszoboszló-Árkoshalom. 145. sír (1:1)

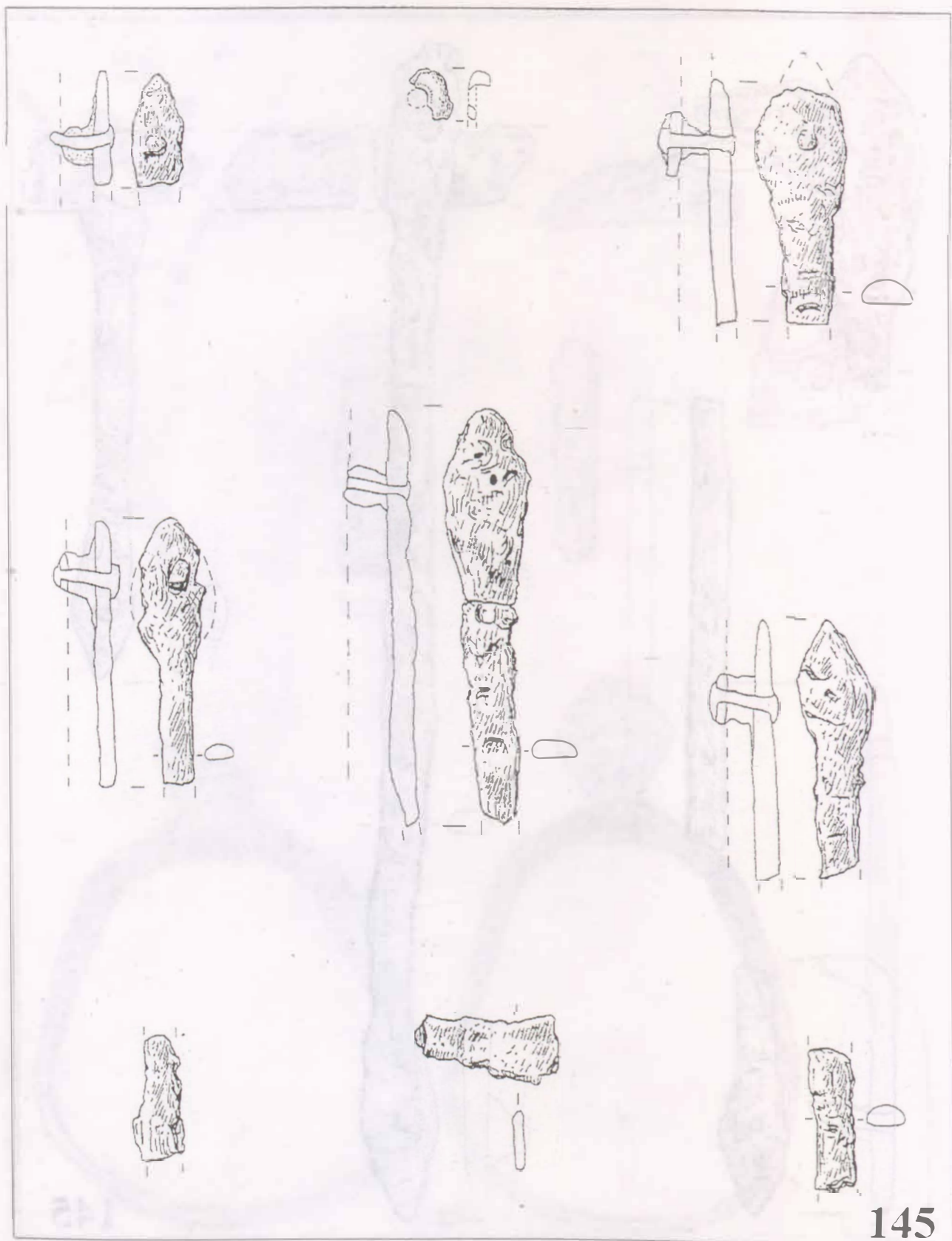

145

70. tábla: Hajdúszoboszló-Árkoshalom. 145. sír (1:1)

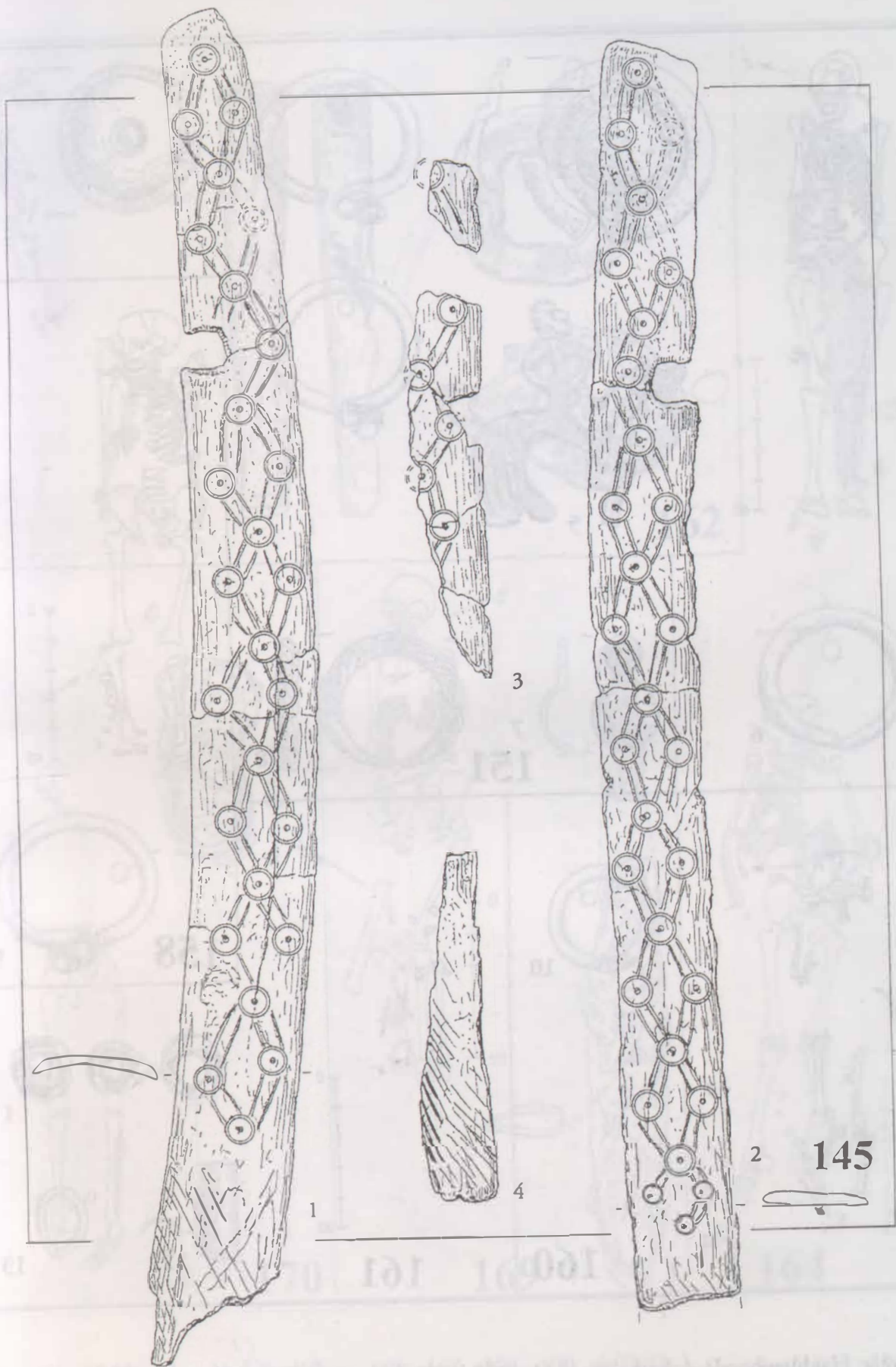

71. tábla: Hajdúszoboszló-Árkoshalom. 145. sír (1:1)

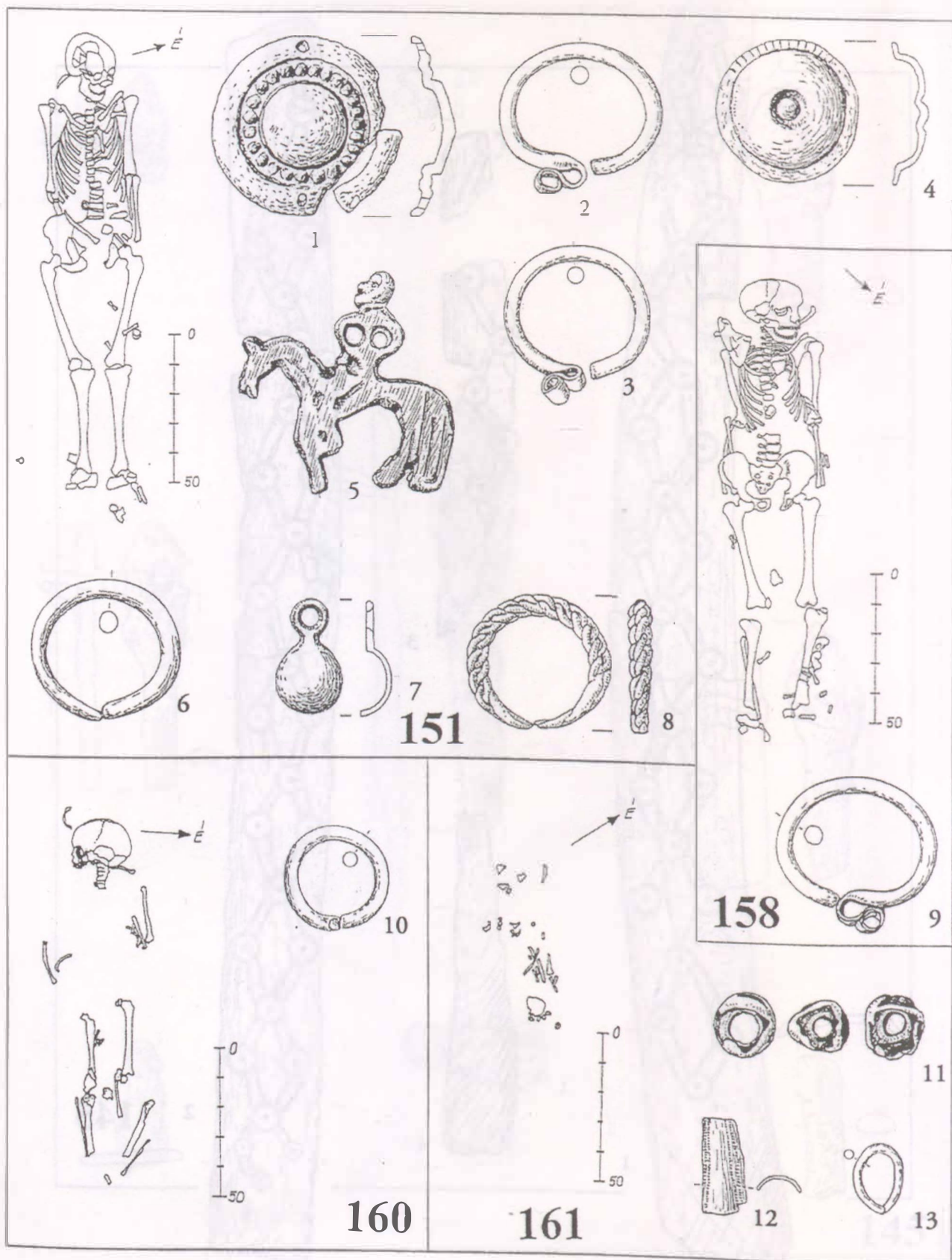

72. tábla: Hajdúszoboszló-Árkoshalom. 151., 158., 160–161. sír (1:1)

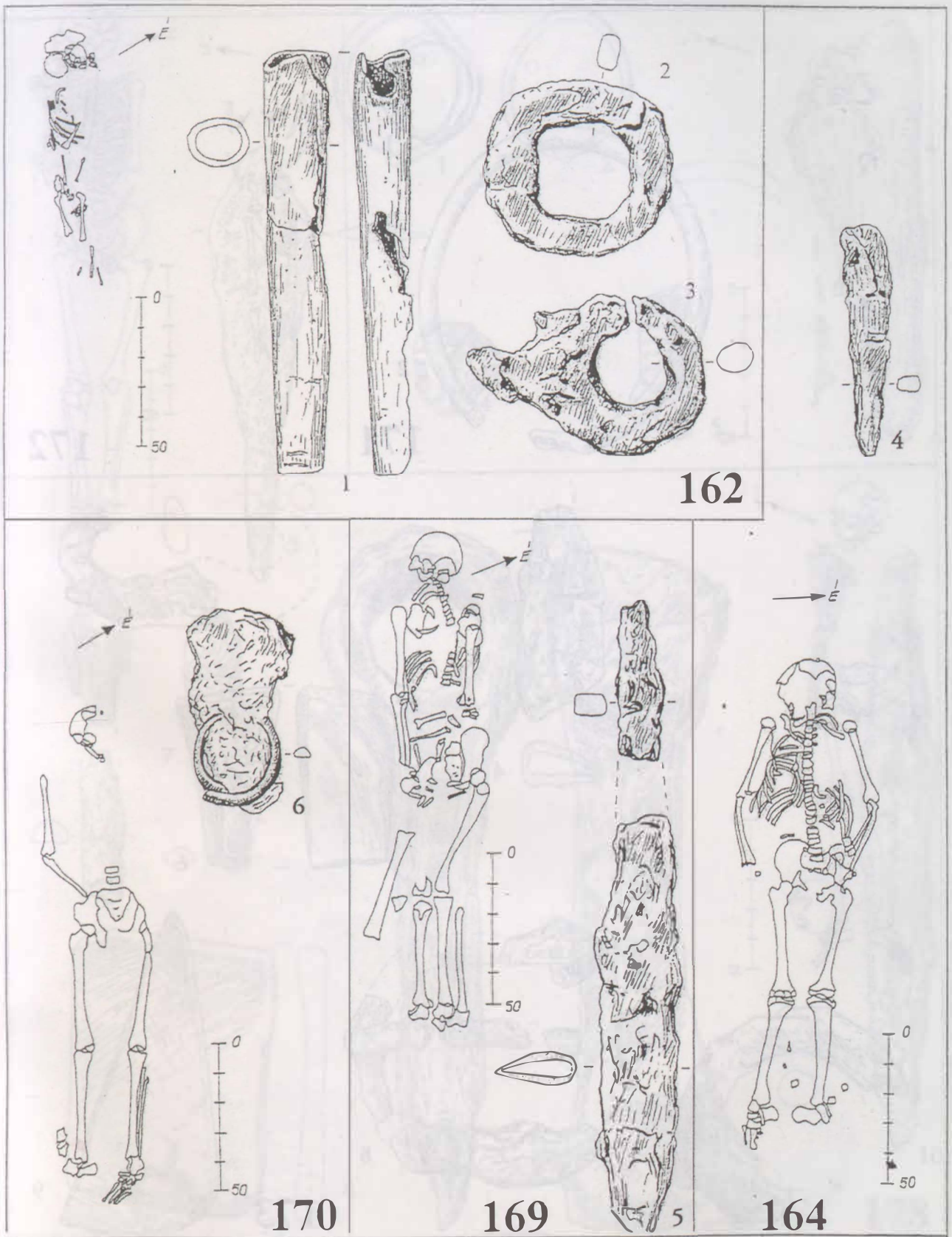

73. tábla: Hajdúszoboszló-Árkoshalom. 162., 164., 169., 170. sír (1:1)

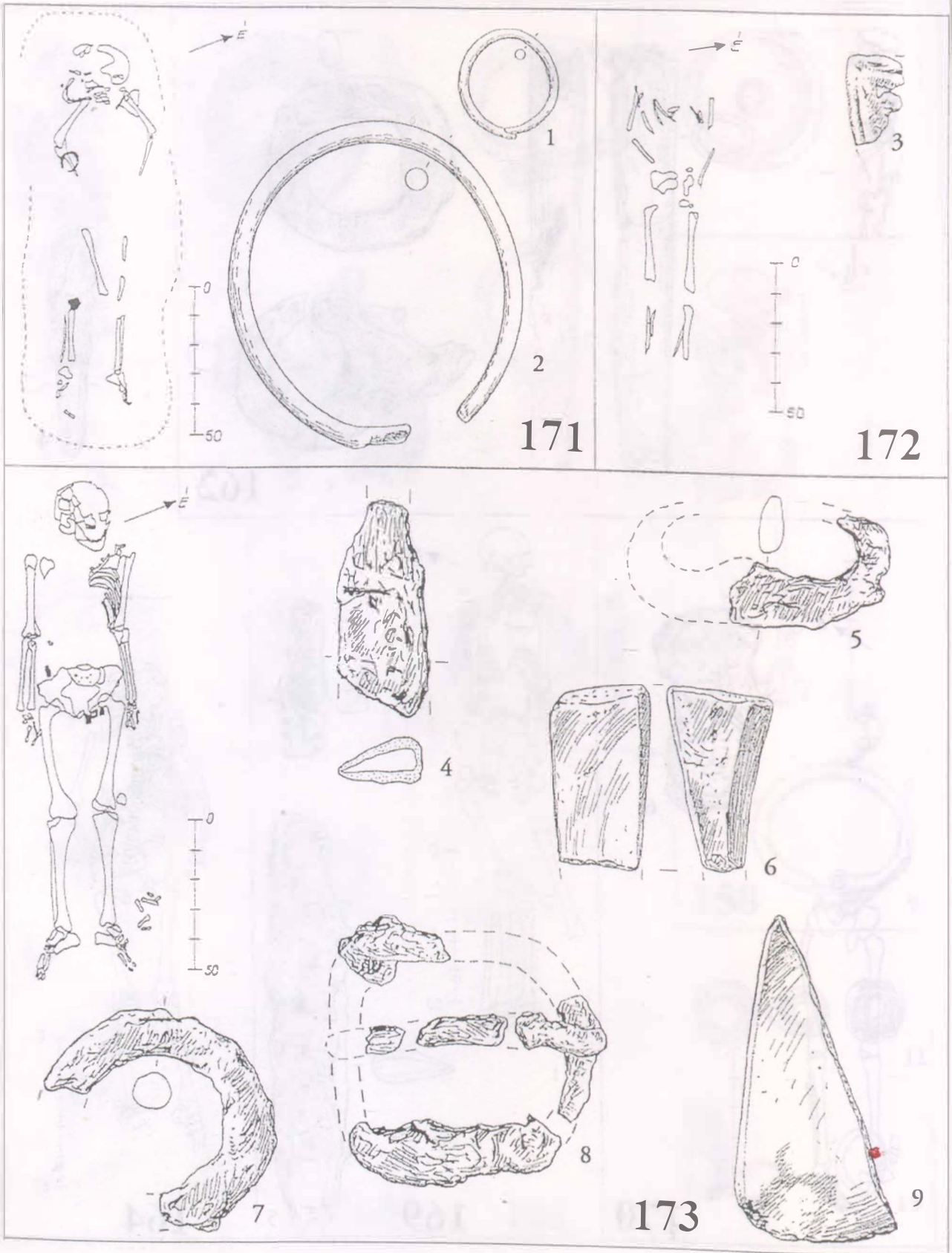

74. tábla: Hajdúszoboszló-Árkoshalom. 171-173. sír (1:1)



75. tábla: Hajdúszoboszló-Árkoshalom. 178. sír (1:1)

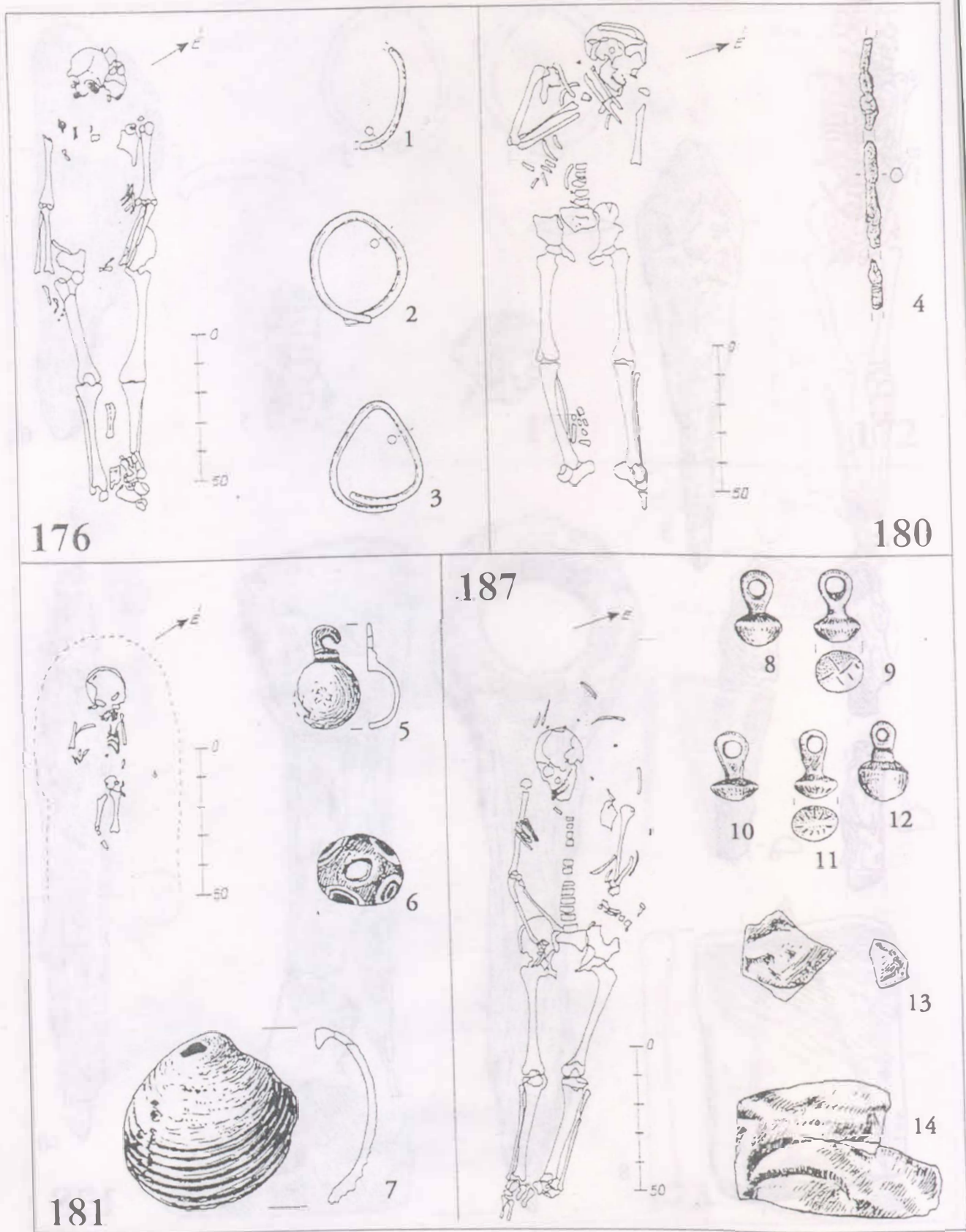

76. tábla: Hajdúszoboszló-Árkoshalom. 176., 180–181., 187. sír (1:1)

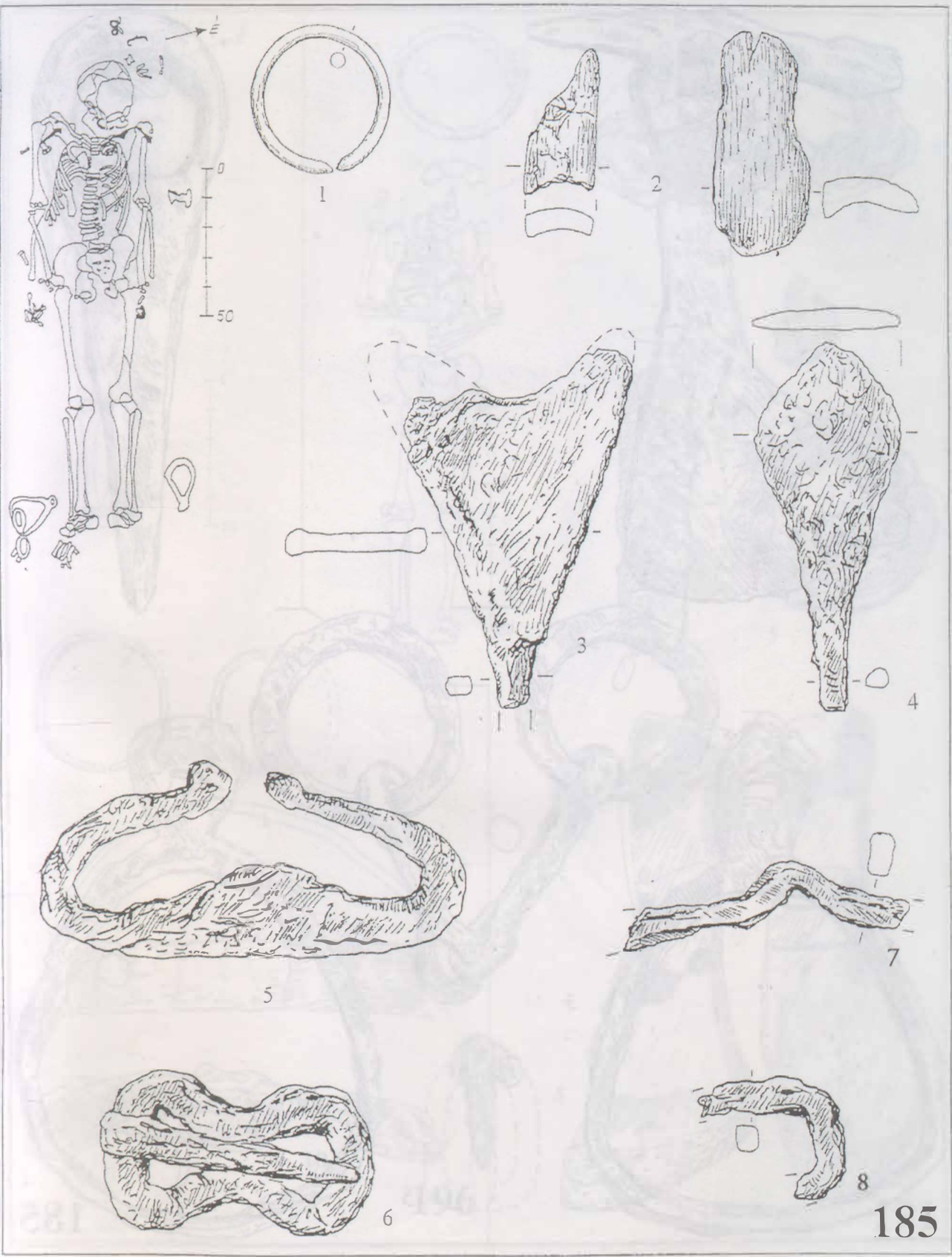

185

77. tábla: Hajdúszoboszló-Árkoshalom. 185. sír (1:1)

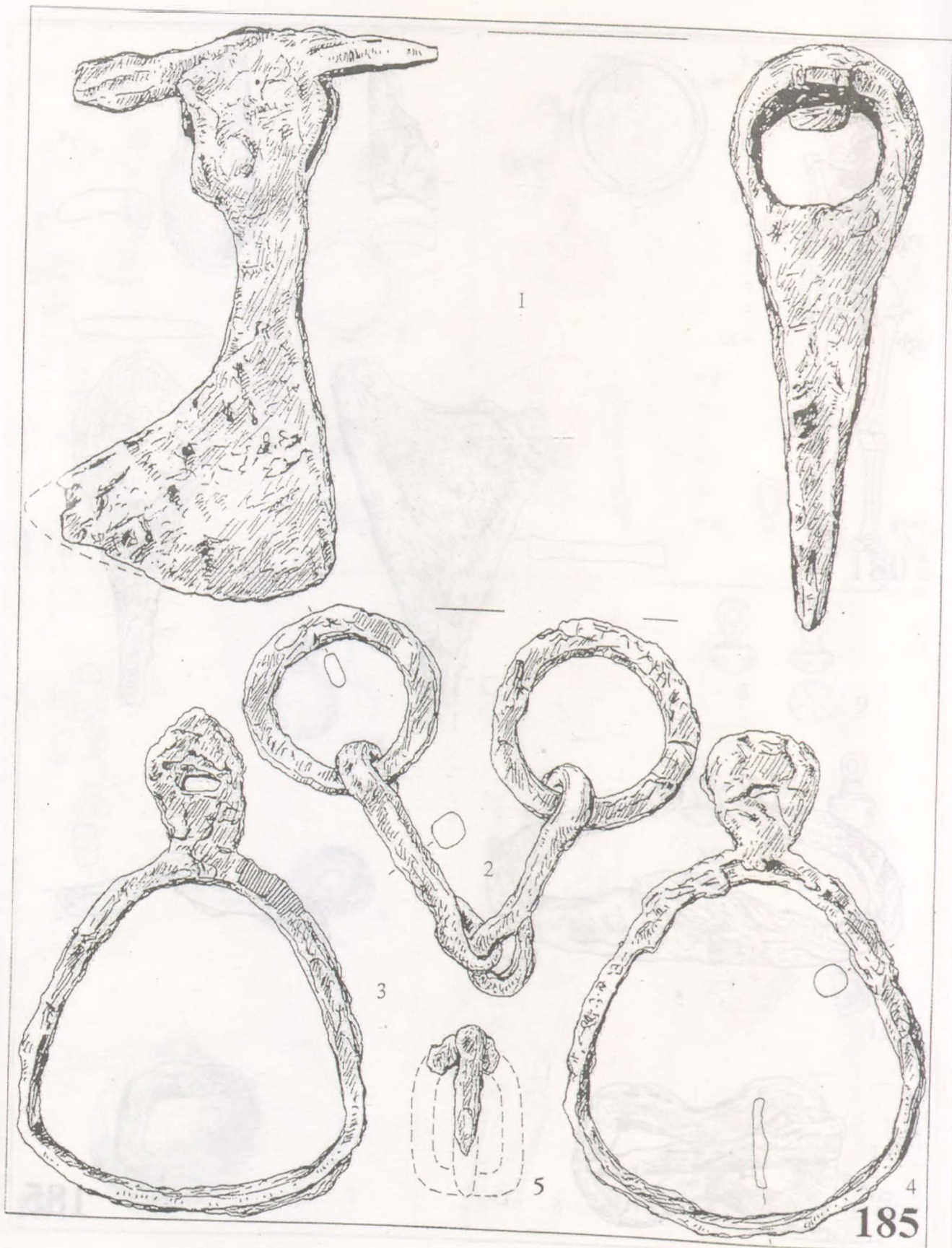

78. tábla: Hajdúszoboszló-Árkoshalom. 185. sír (1-4. 1:1; 2-3. 1:2)

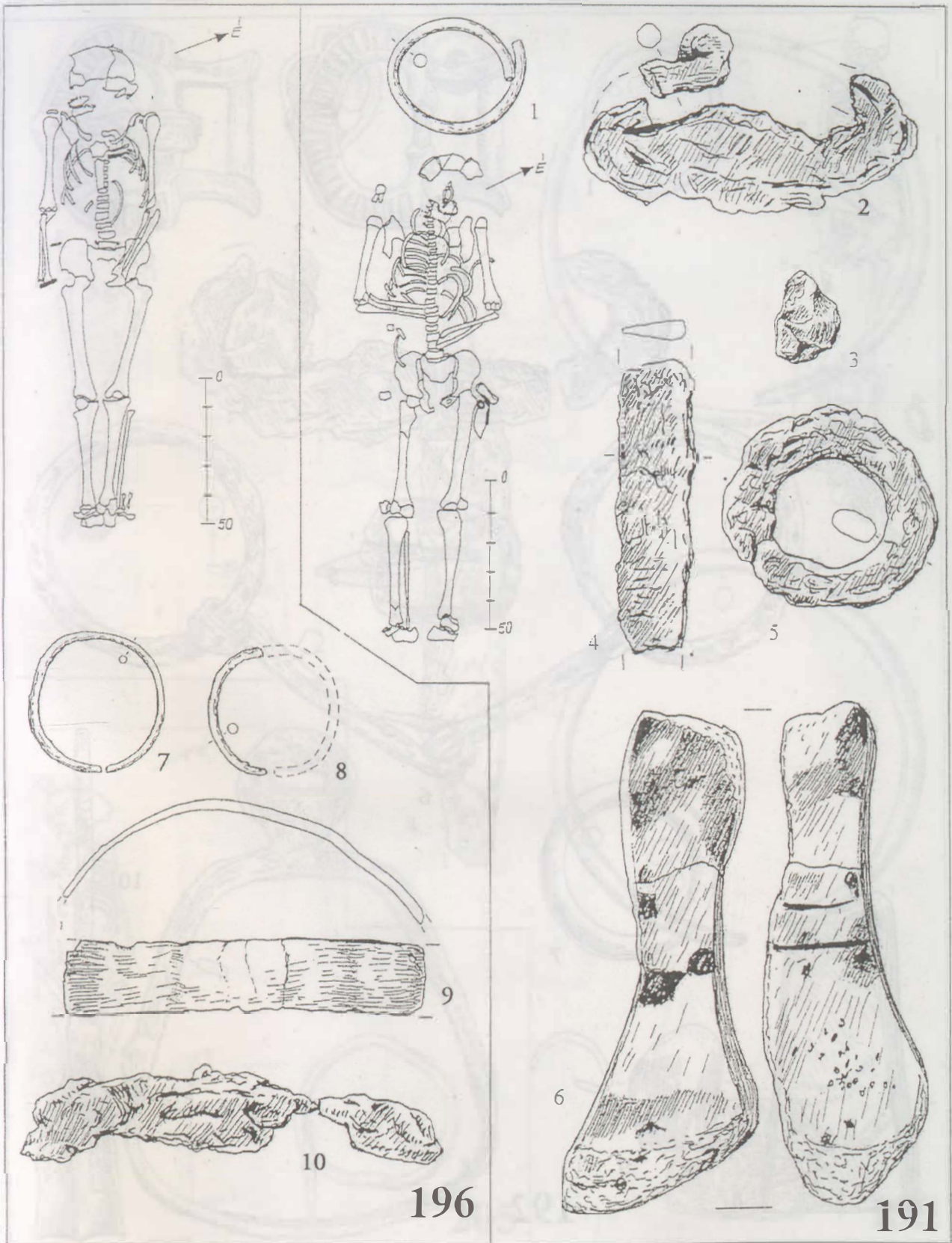

79. tábla: Hajdúszoboszló-Árkoshalom. 191., 196. sír (1:1)

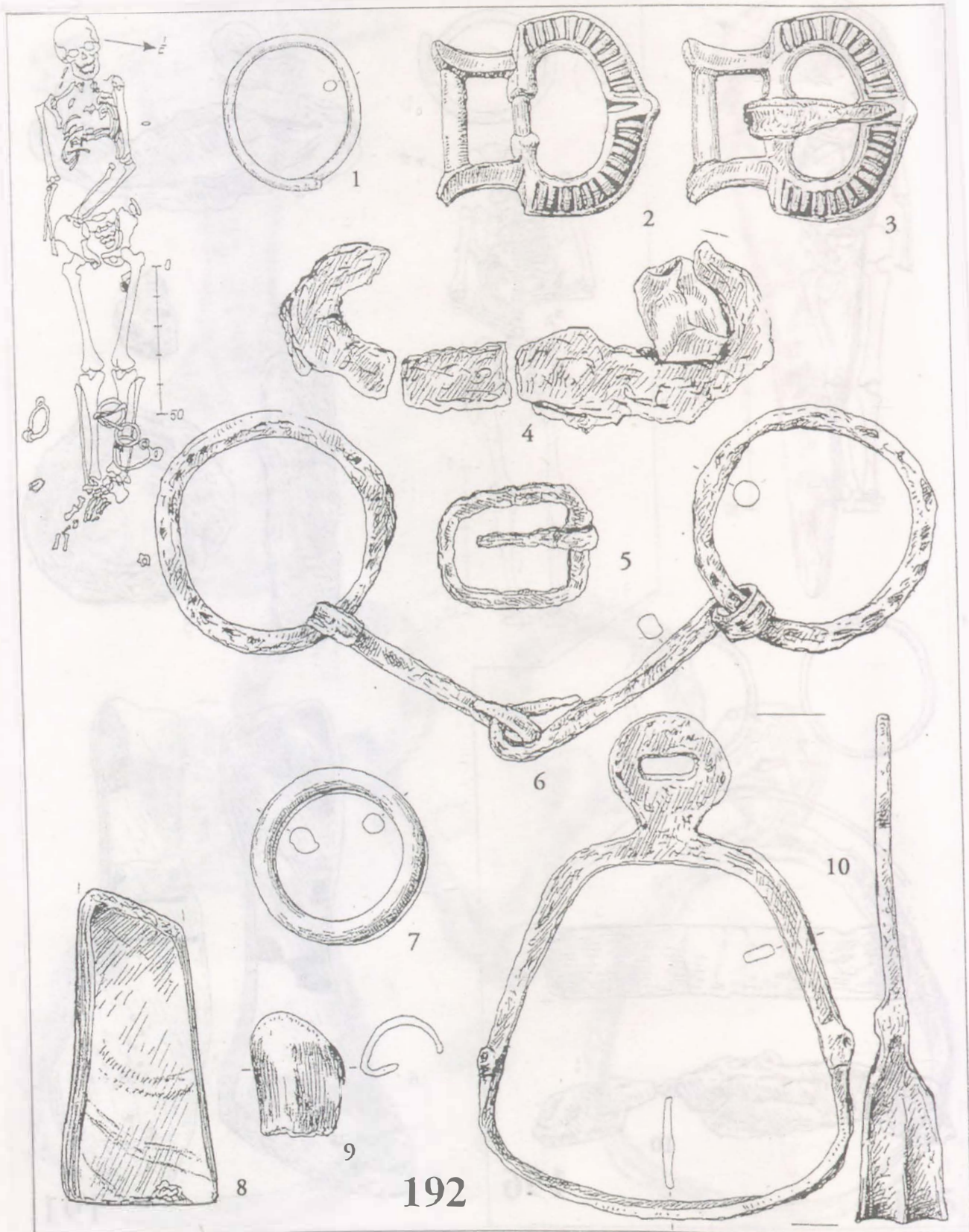

80. tábla: Hajdúszoboszló-Árkoshalom. 192. sír (1-4., 7-9. 1:1; 5-6., 10. 1:2)

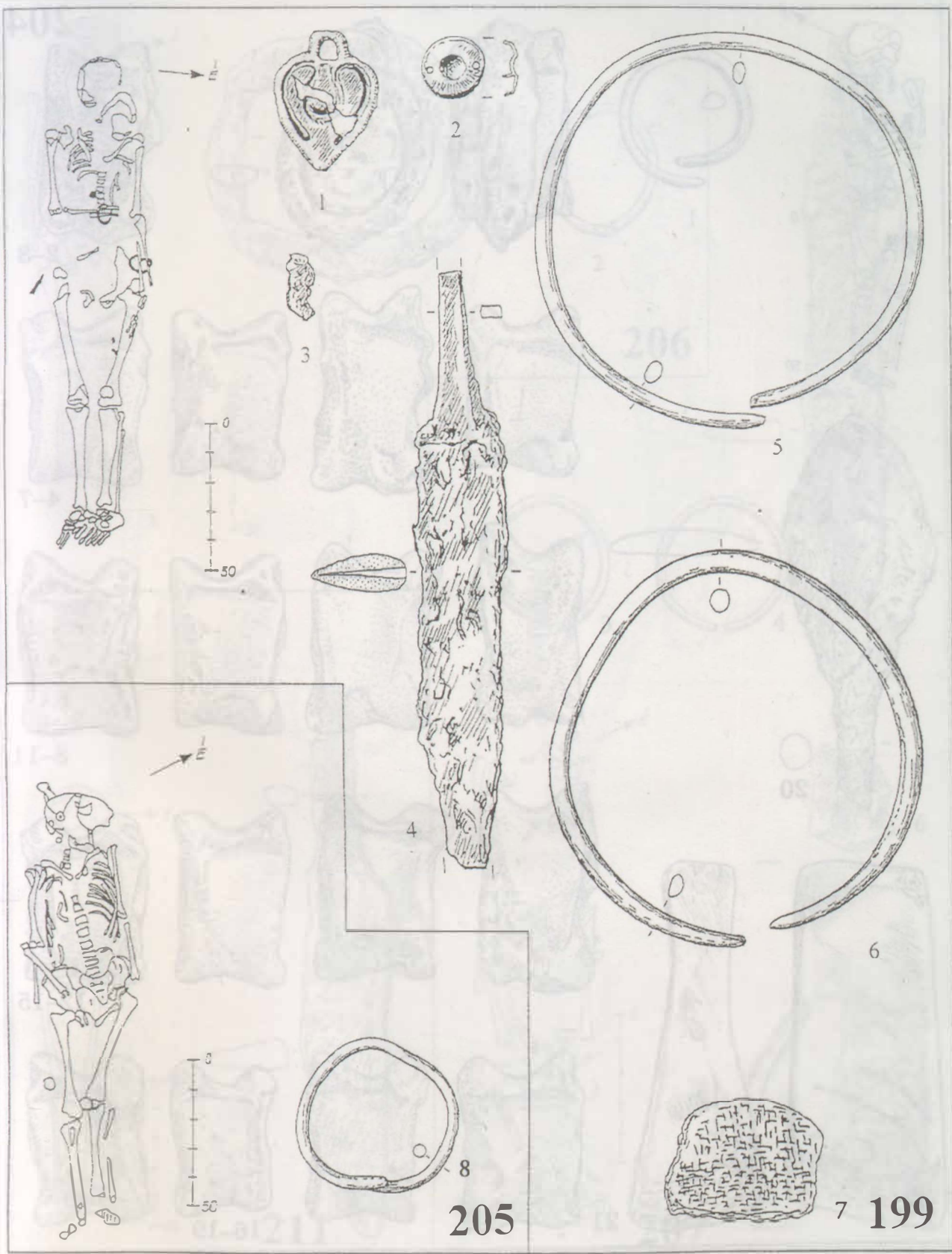

81. tábla: Hajdúszoboszló-Árkoshalom. 199., 205. sír (1:1)

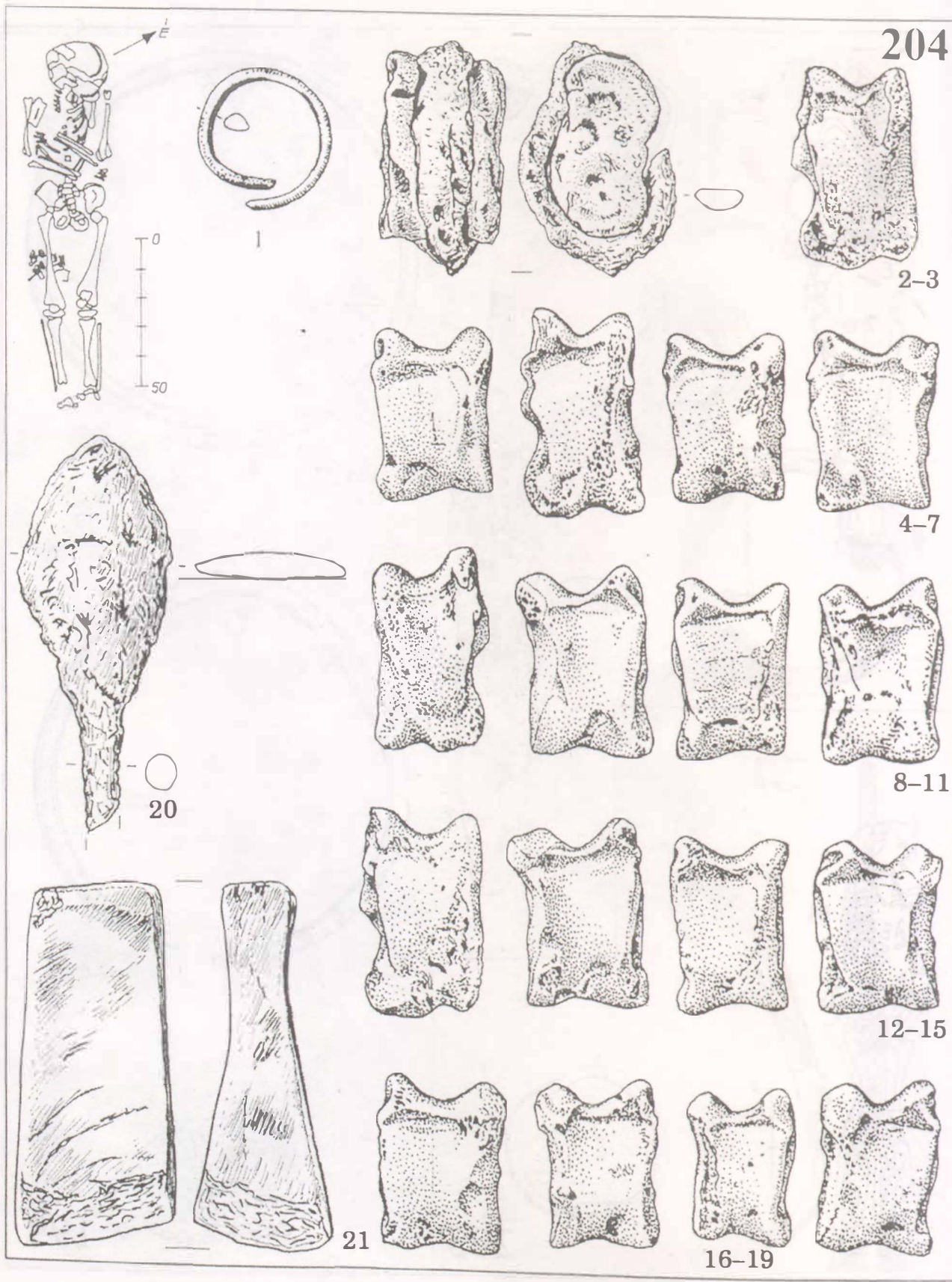

82. tábla: Hajdúszoboszló-Árkoshalom. 204. sír (1:1)

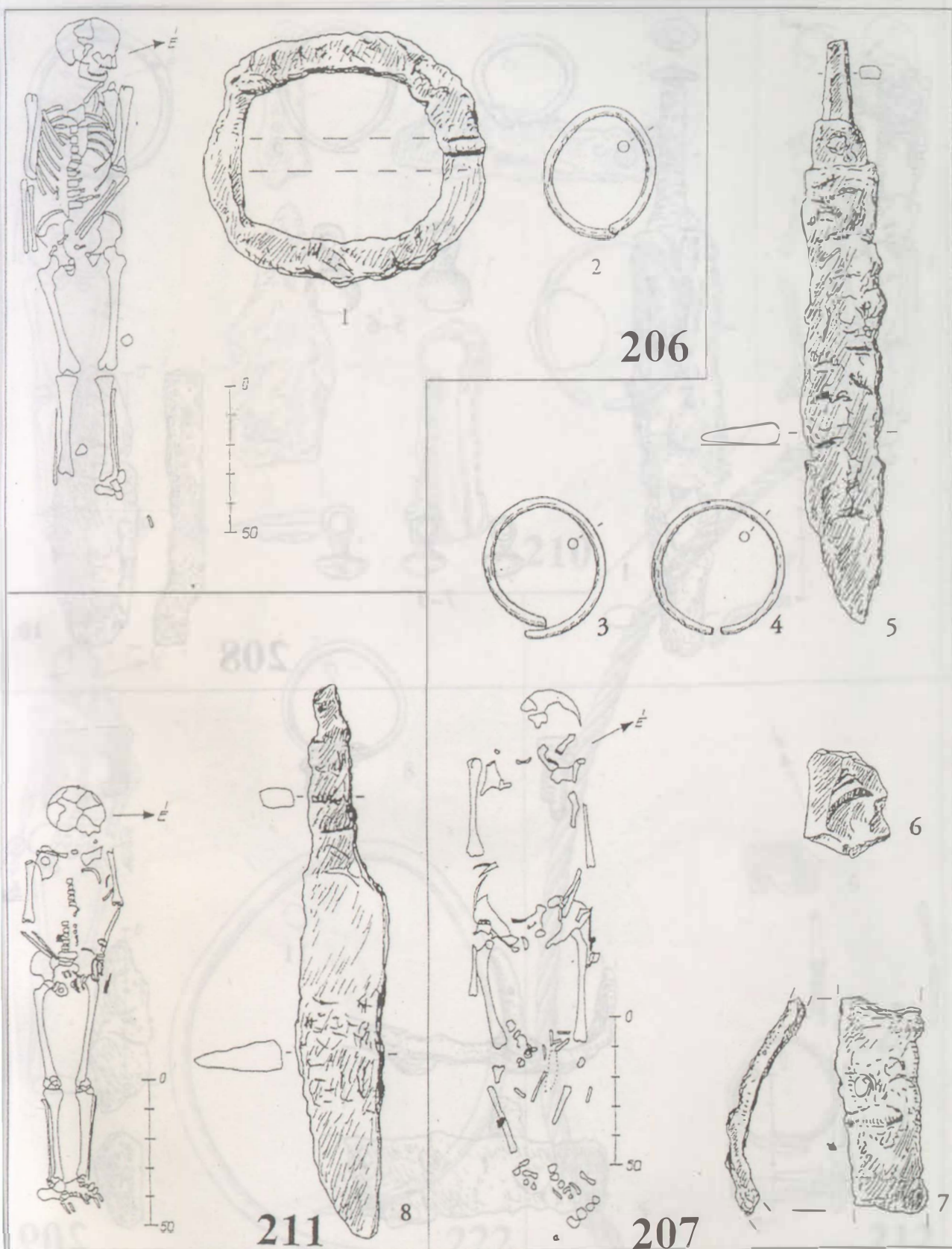

83. tábla: Hajdúszoboszló-Árkoshalom. 206–207., 211. sír (1:1)

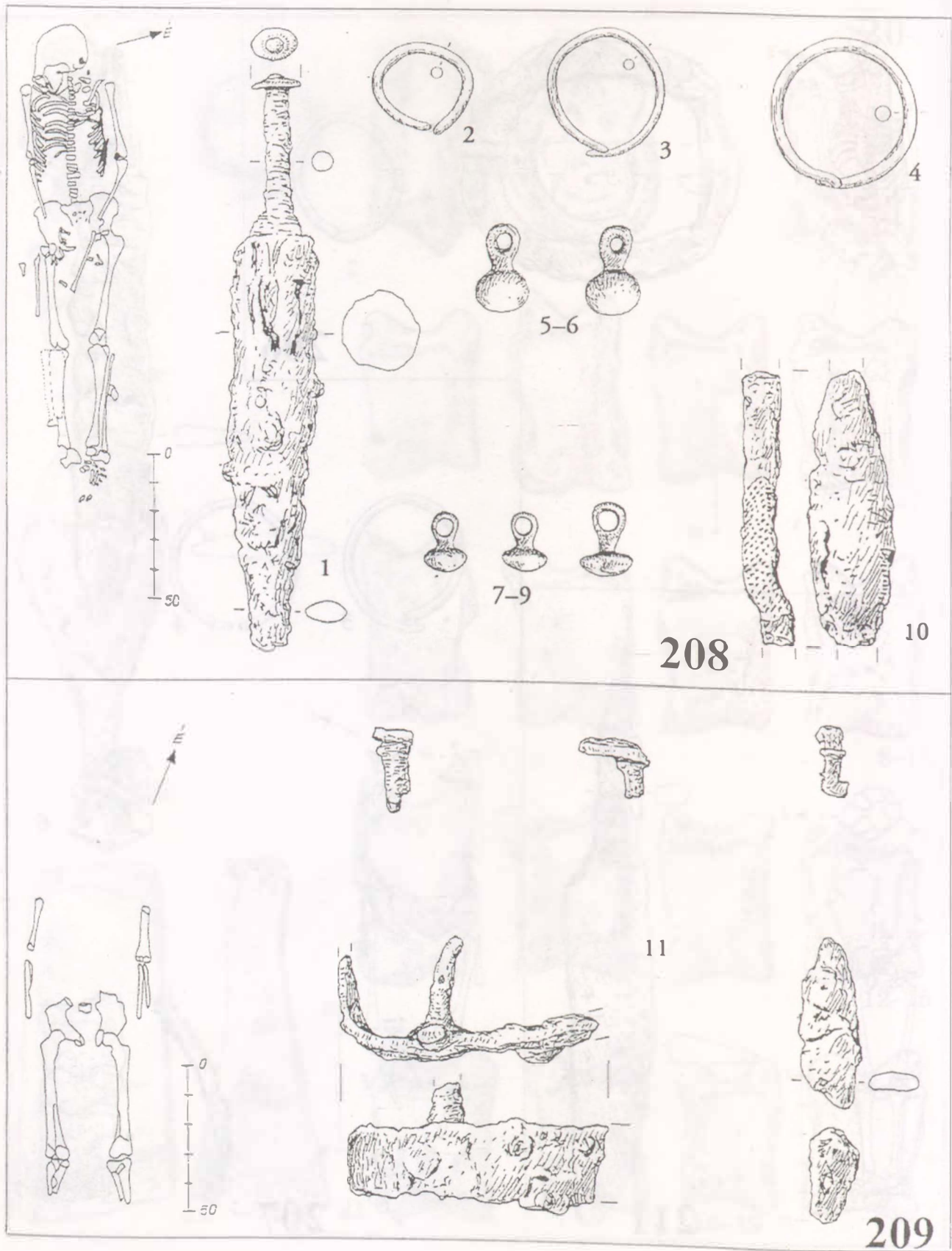

84. tábla: Hajdúszoboszló-Árkoshalom. 208–209. sír (1:1)

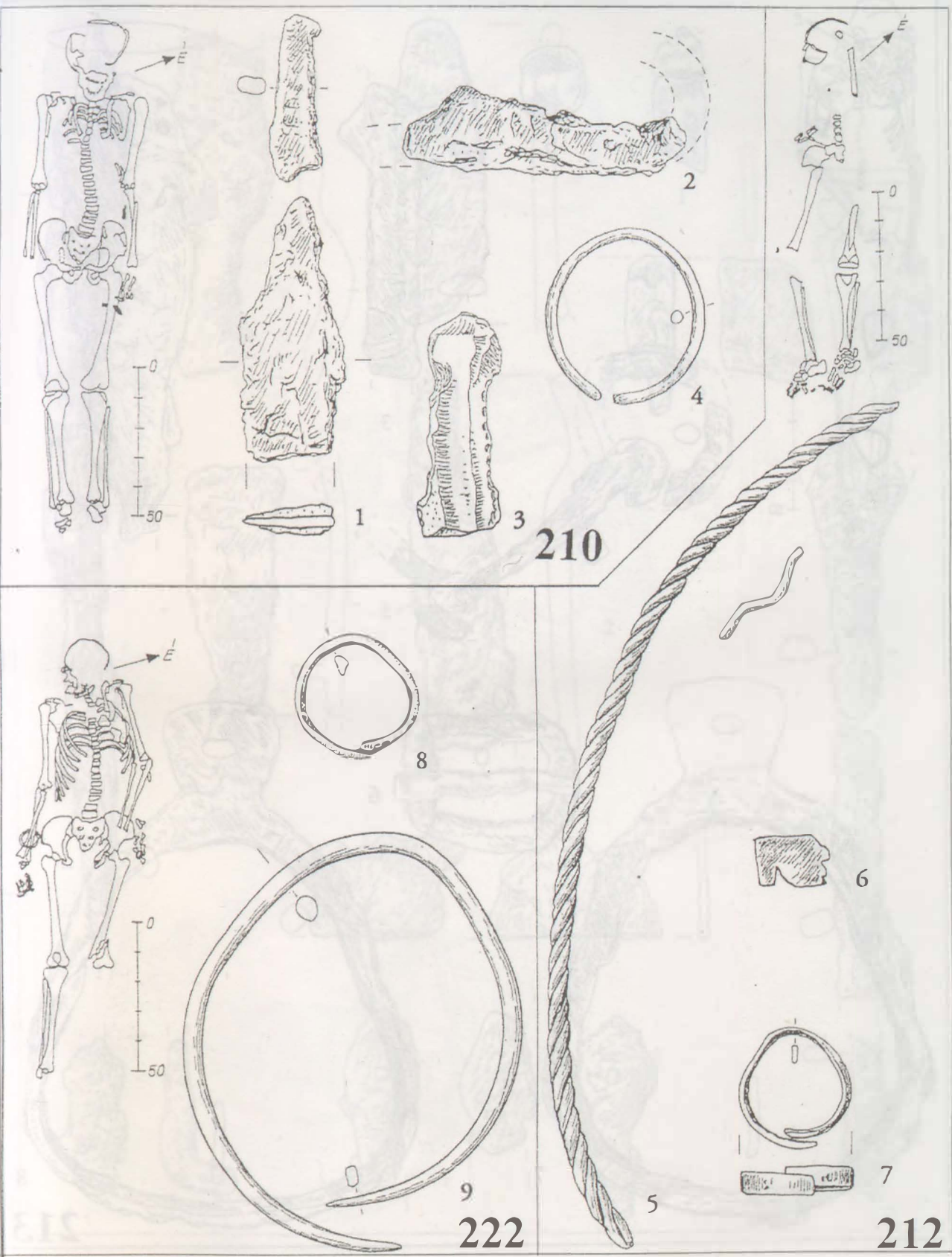

85. tábla: Hajdúszoboszló-Árkoshalom. 210., 212., 222. sír (1:1)

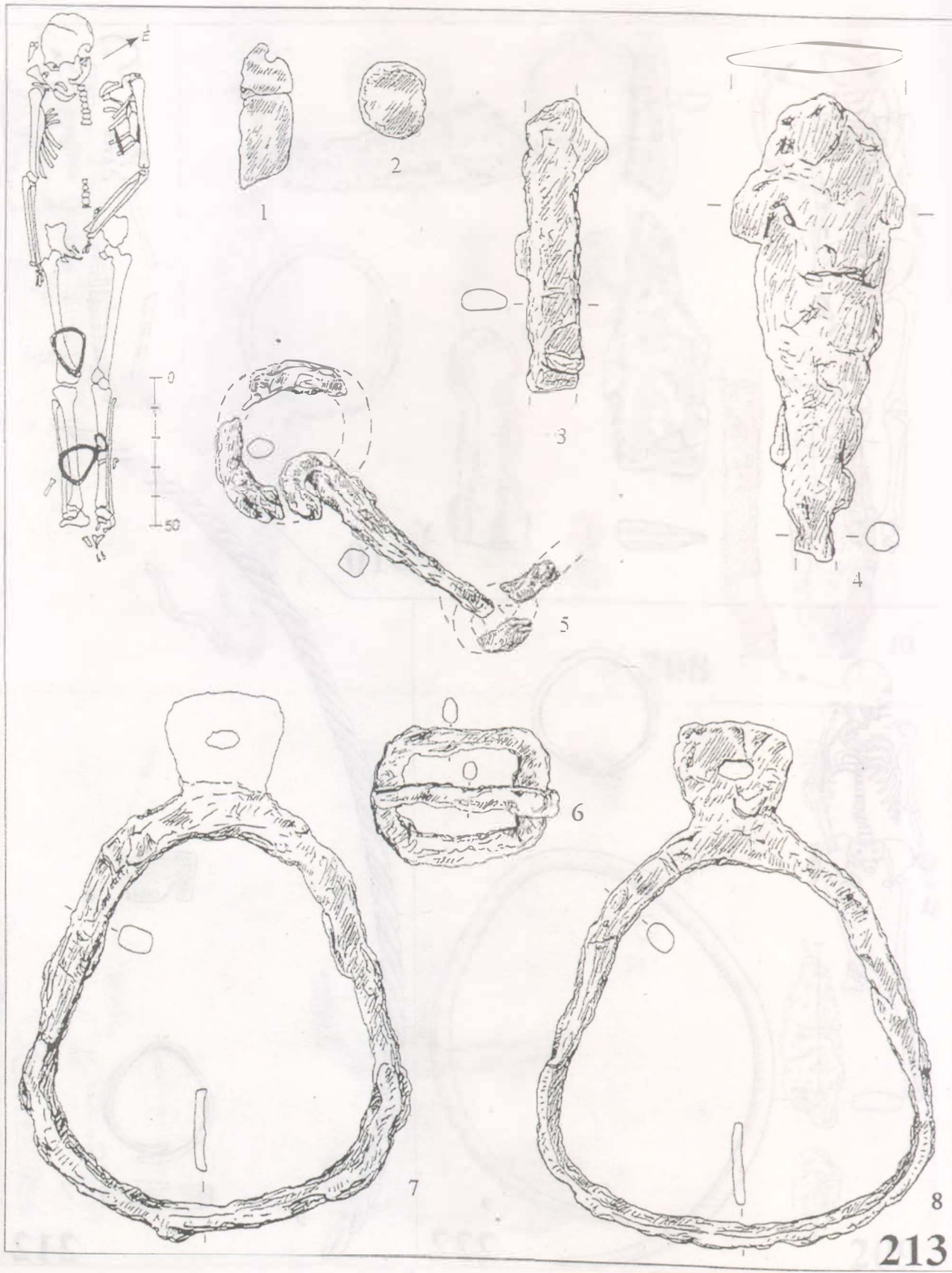

86. tábla: Hajdúszoboszló-Árkoshalom. 213. sír (1-4. 1:1; 5-8. 1:2)

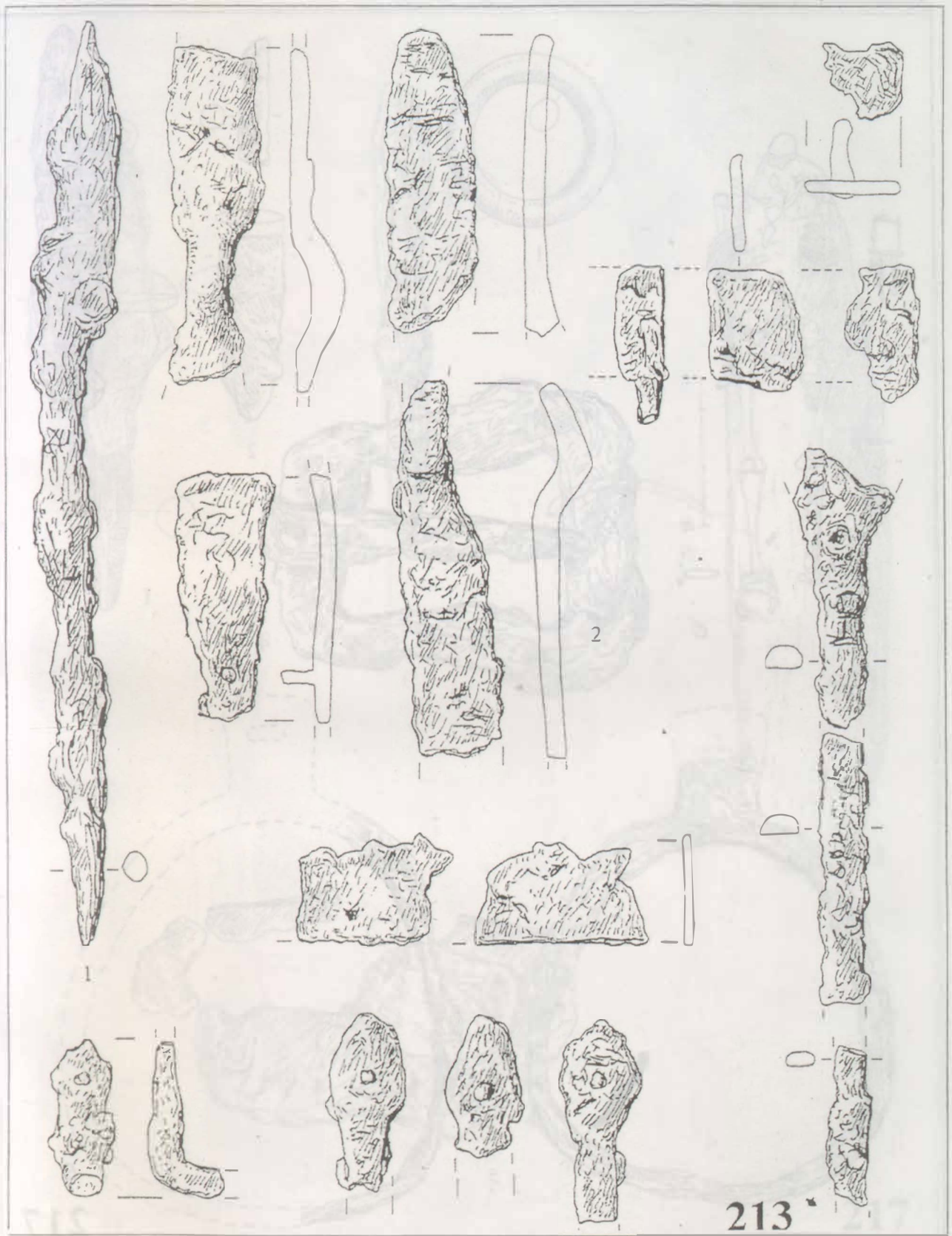

87. tábla: Hajdúszoboszló-Árkoshalom, 213. sír (1:1)

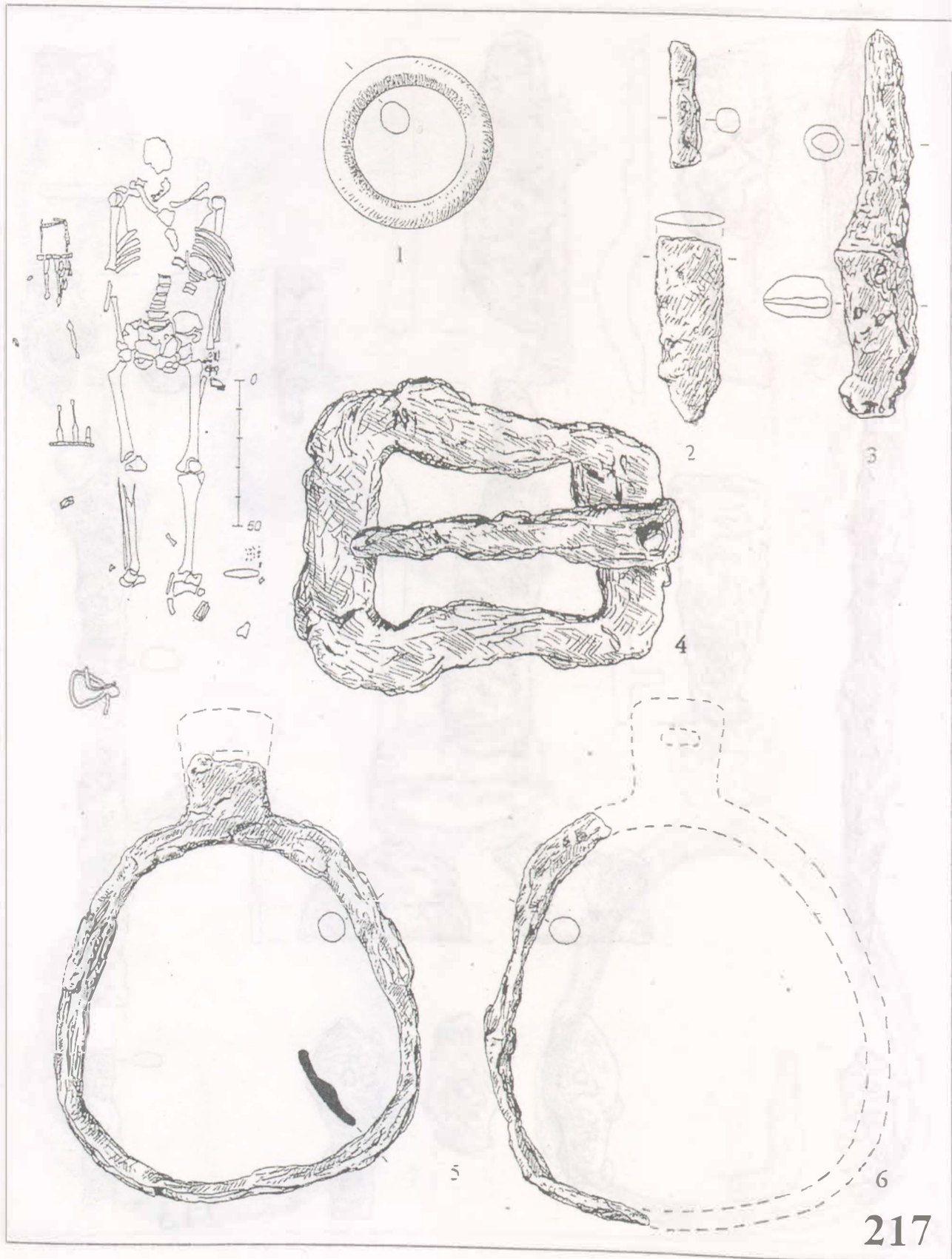

217

88. tábla: Hajdúszoboszló-Árkoshalom. 217. sír (1-4. 1:1; 5-6. 1:2)

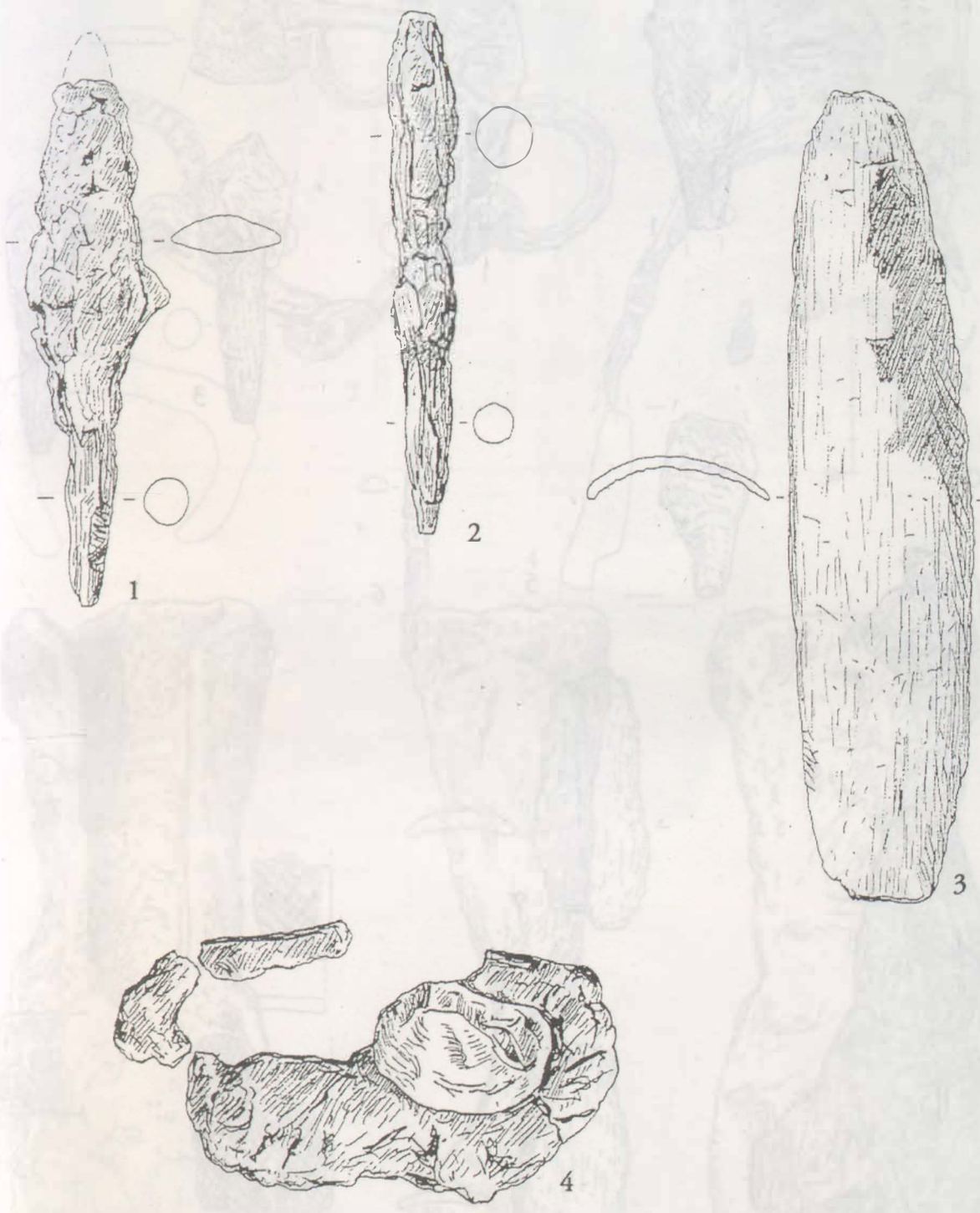

217

89. tábla: Hajdúszoboszló-Árkoshalom: 217. sír (1:1)



90. tábla: Hajdúszoboszló-Árkoshalom. 220. sír (1:1)

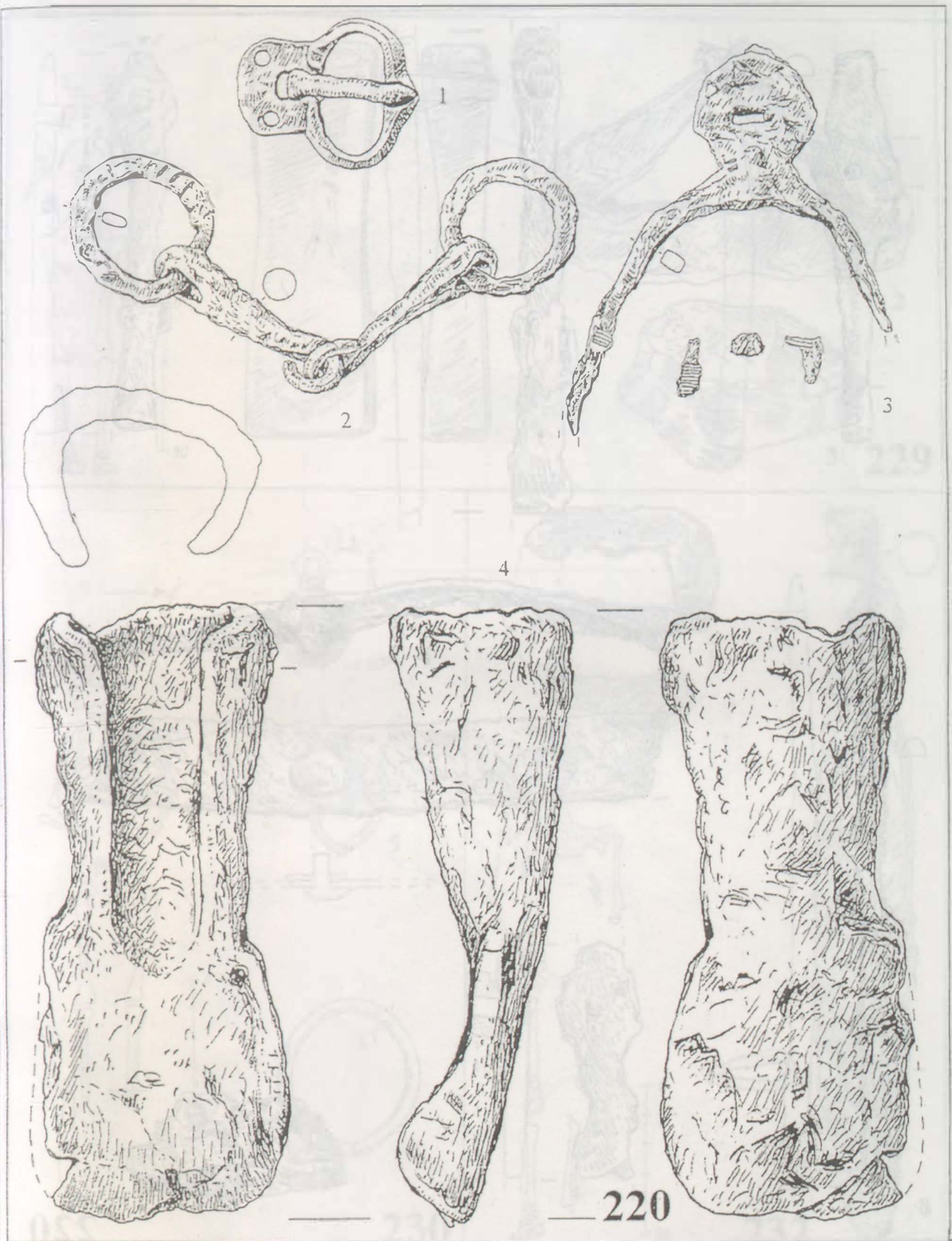

91. tábla: Hajdúszoboszló-Árkoshalom. 220. sír (1., 4. 1:1; 2-3. 1:2)

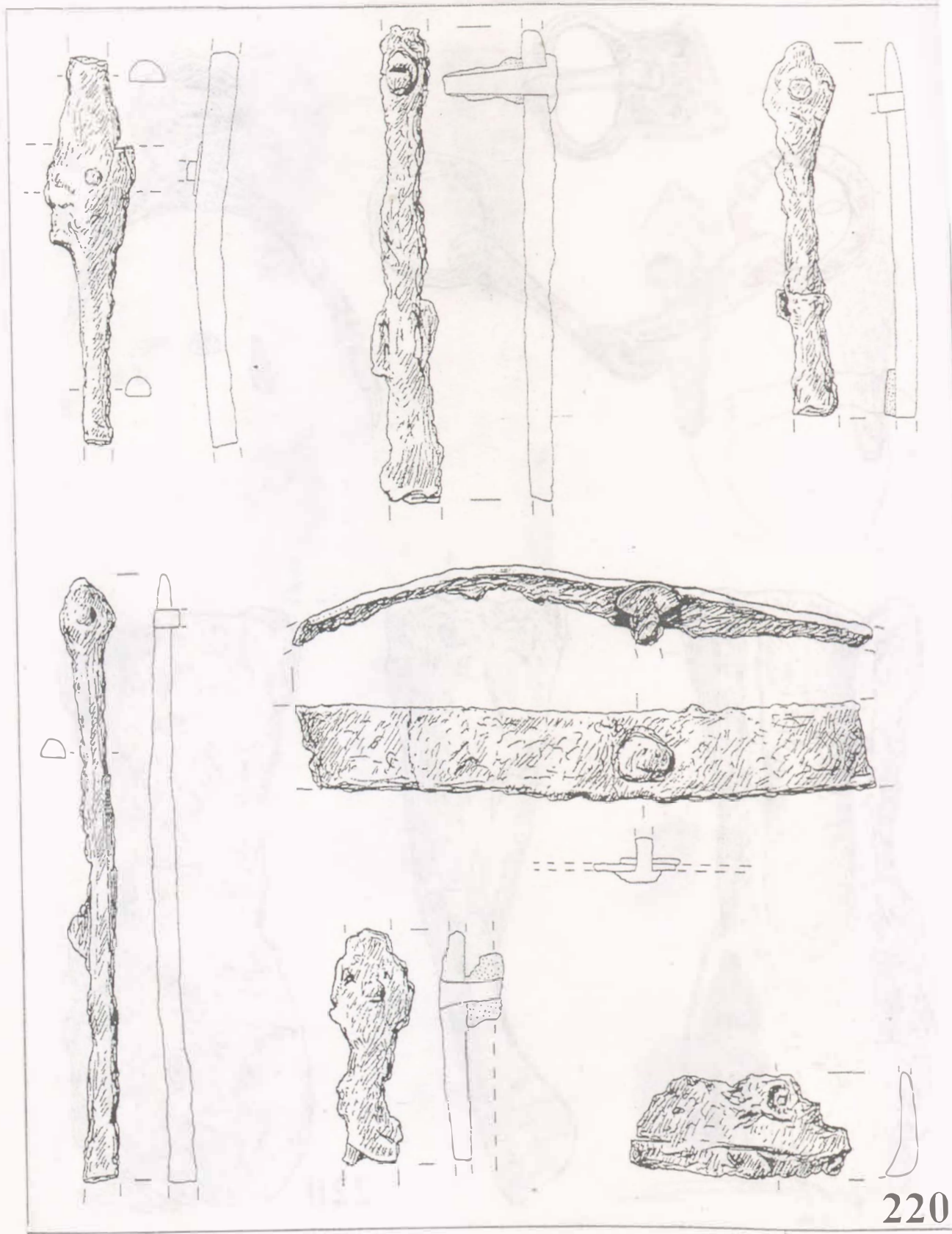

220

92. tábla: Hajdúszoboszló-Árkoshalom. 220. sír (1:1)



229

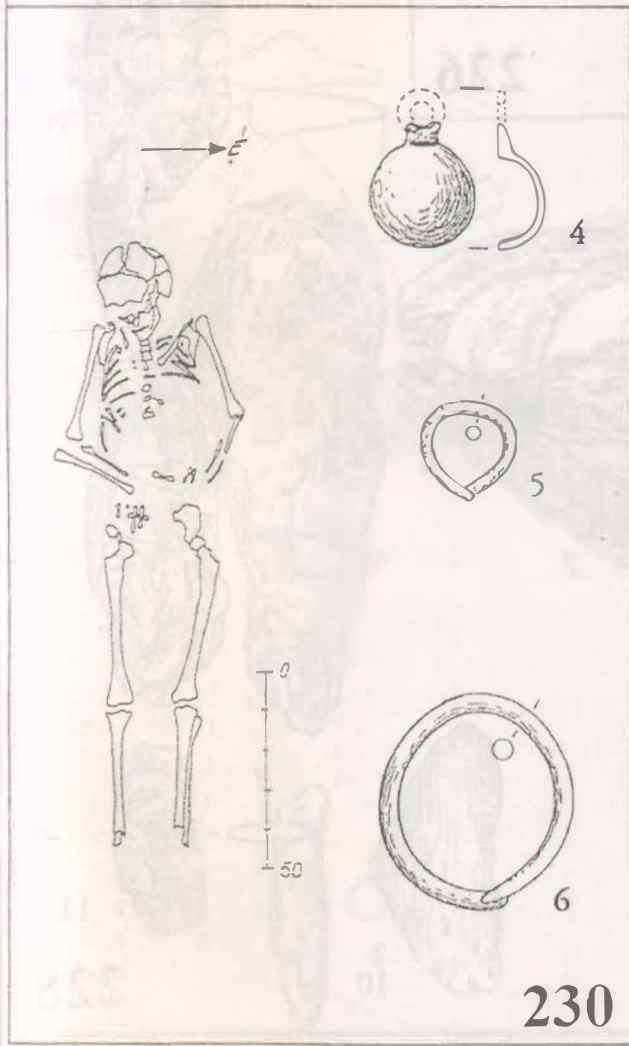

230



232

93. tábla: Hajdúszoboszló-Árkoshalom. 229–230., 232. sír (1:1)

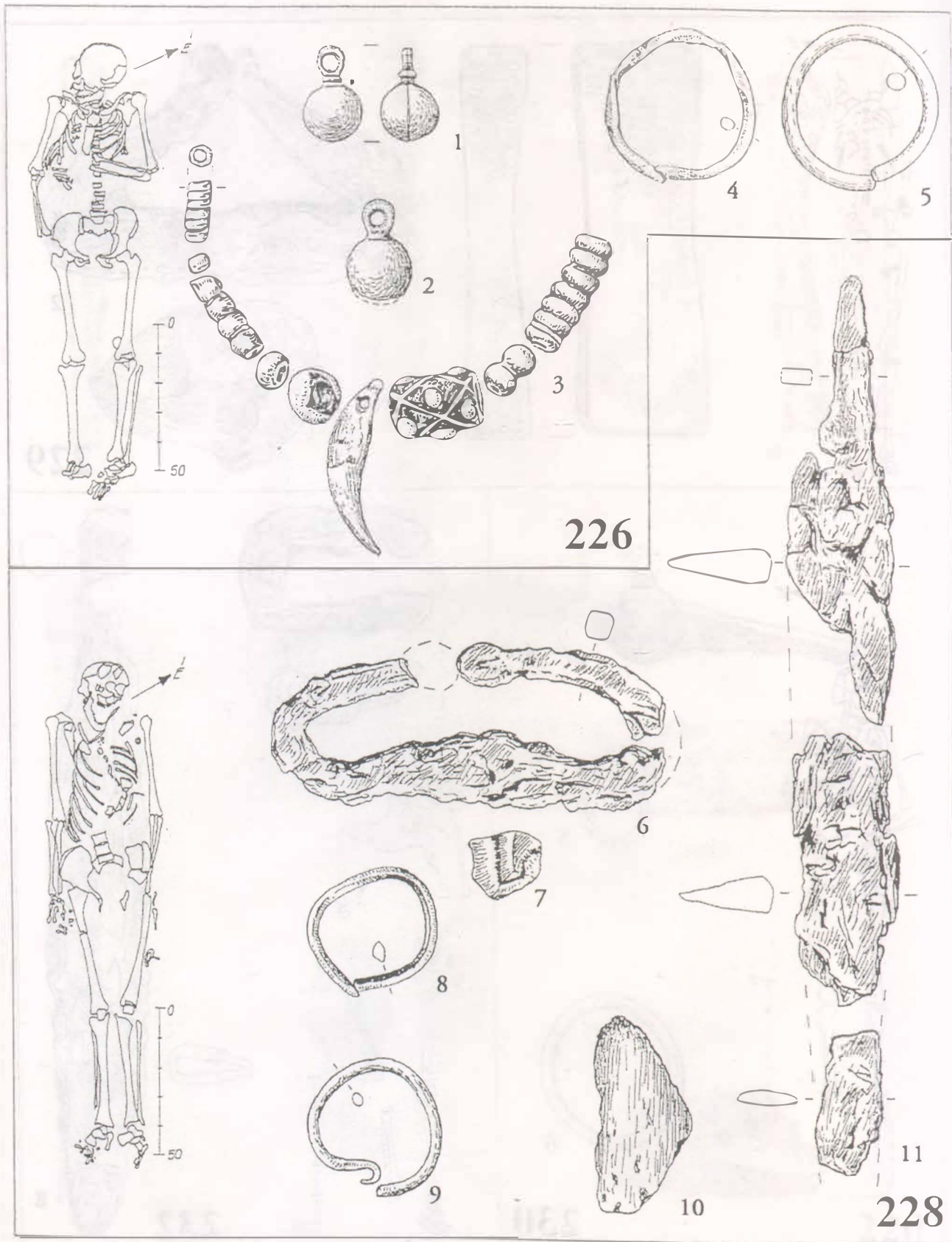

94. tábla: Hajdúszoboszló-Árkoshalom. 226., 228. sír (1:1)

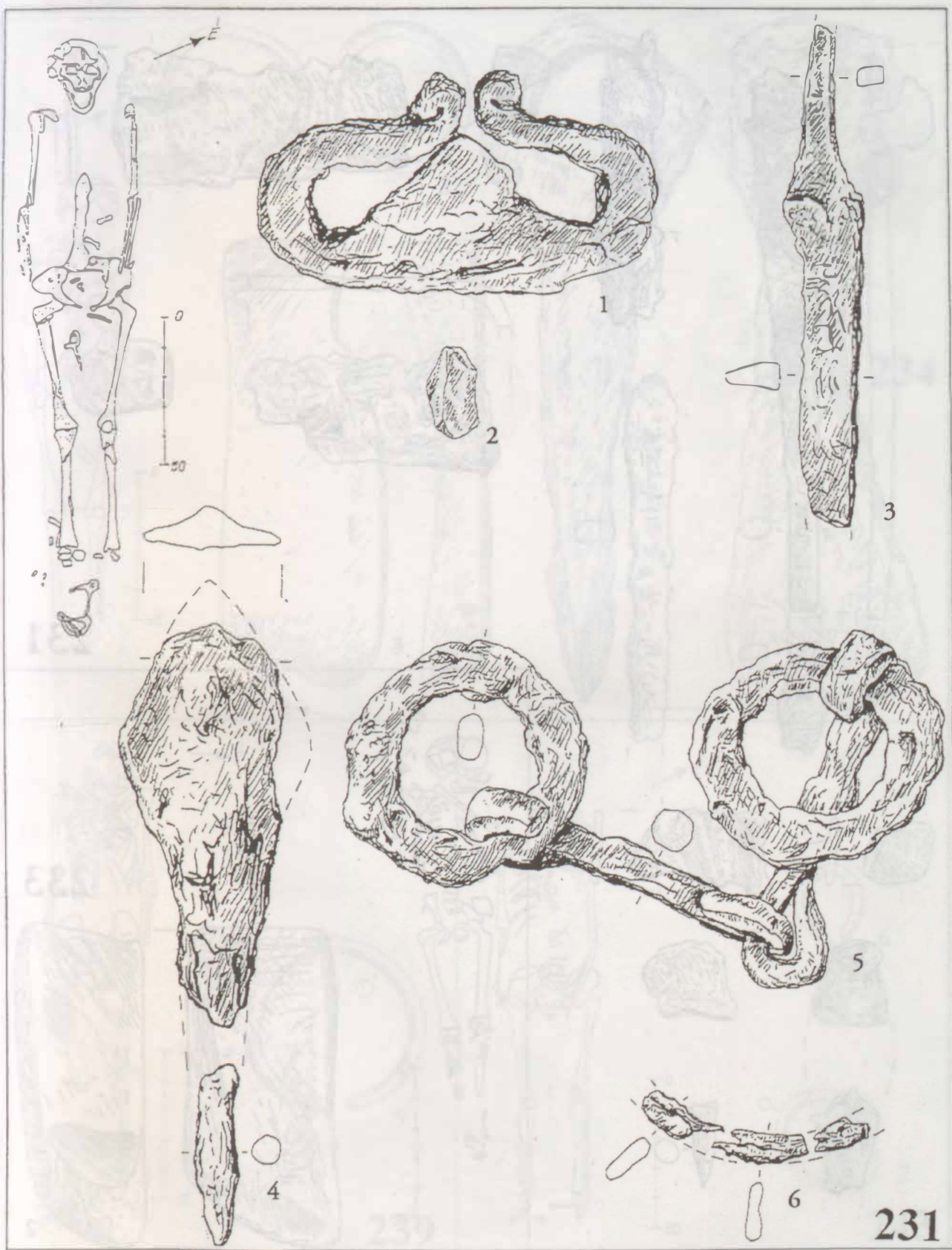

95. tábla: Hajdúszoboszló-Árkoshalom. 231. sír (1-4., 6. 1:1; 5. 1:2)

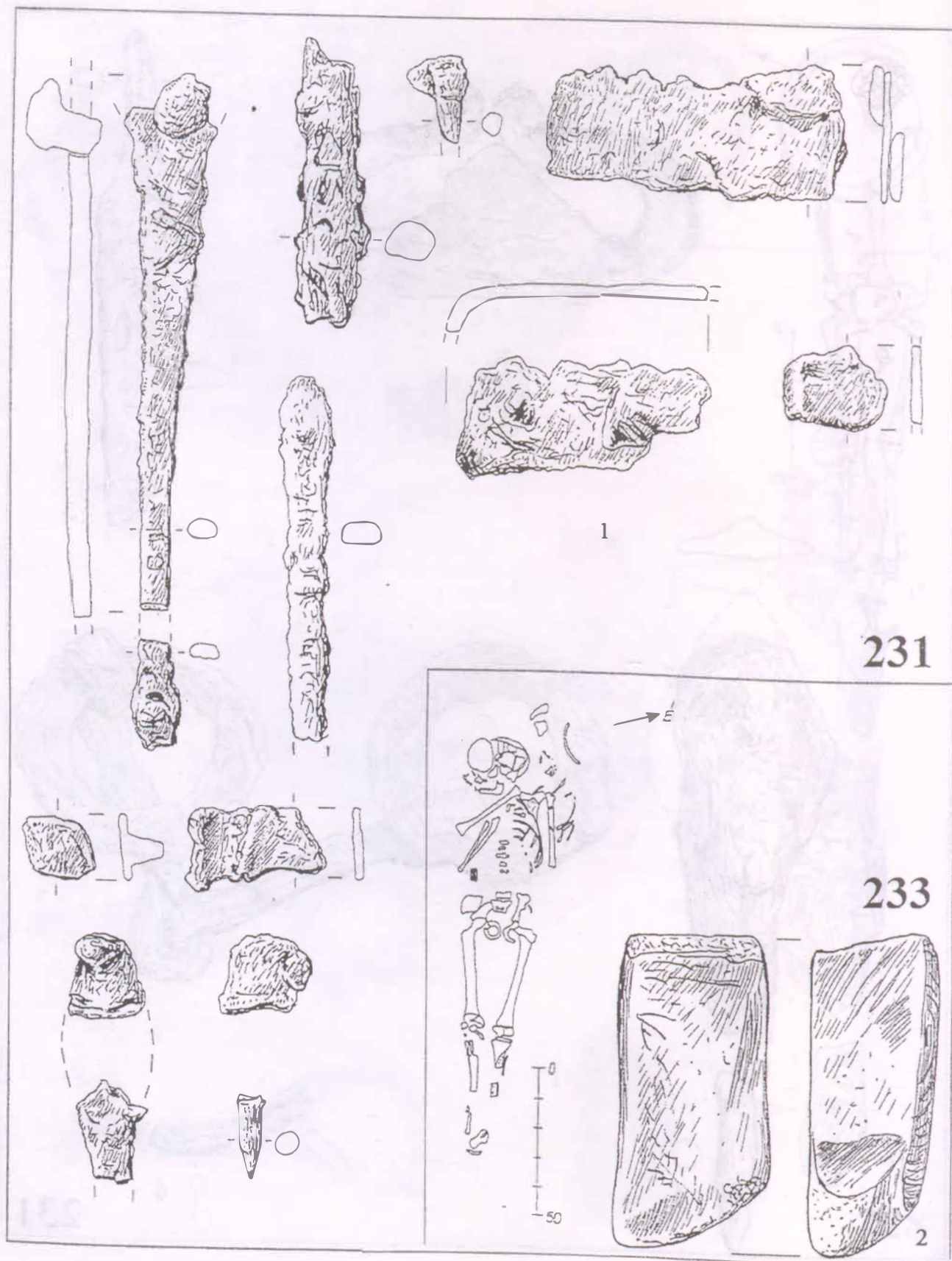

96. tábla: Hajdúszoboszló-Árkoshalom. 231., 233. sír (1:1)

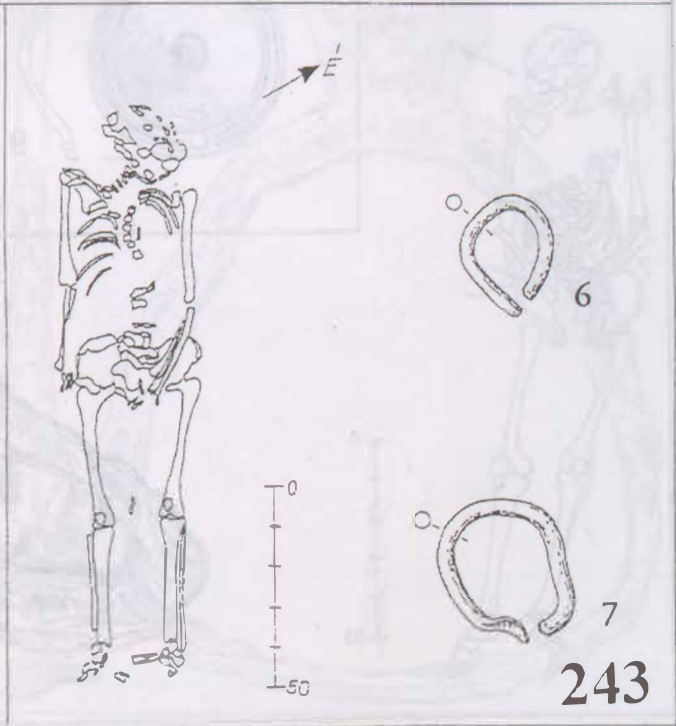
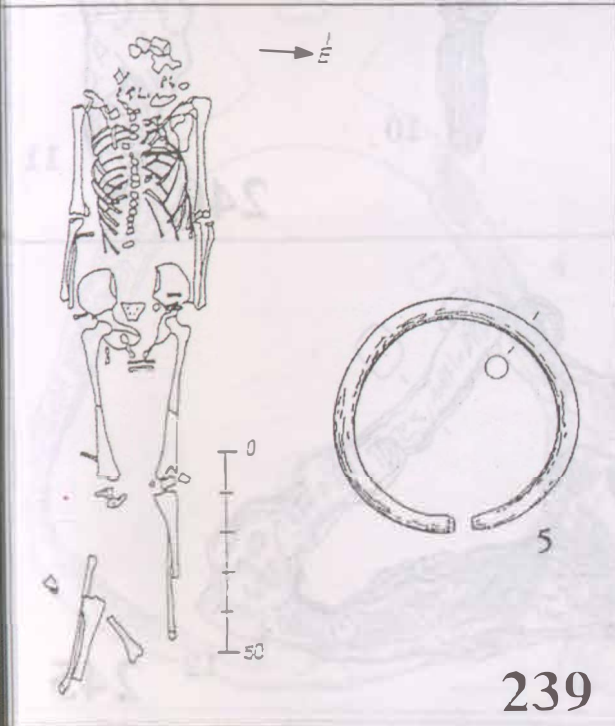
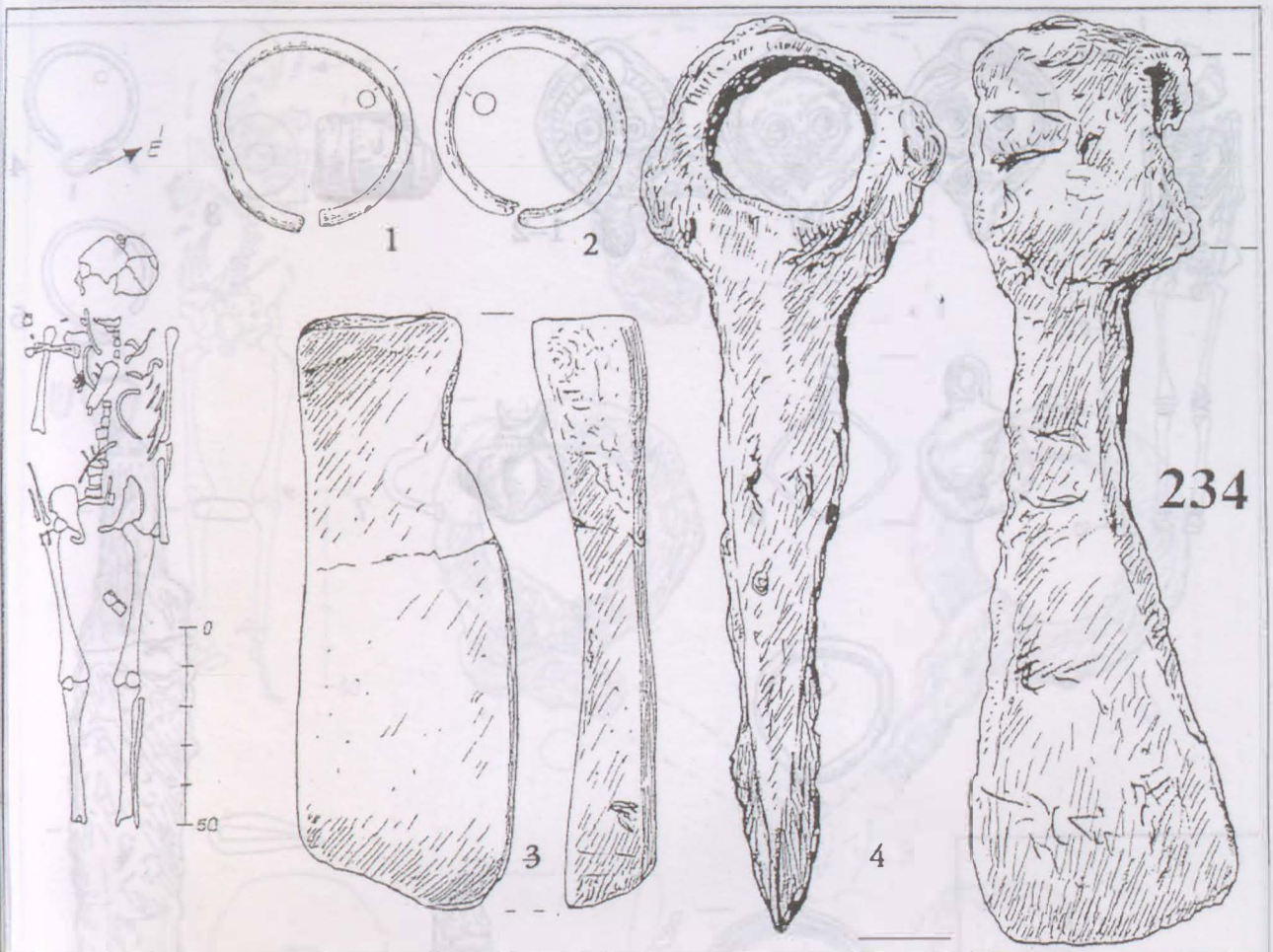

97. tábla: Hajdúszoboszló-Árkoshalom. 234., 239., 243. sír (1:1)

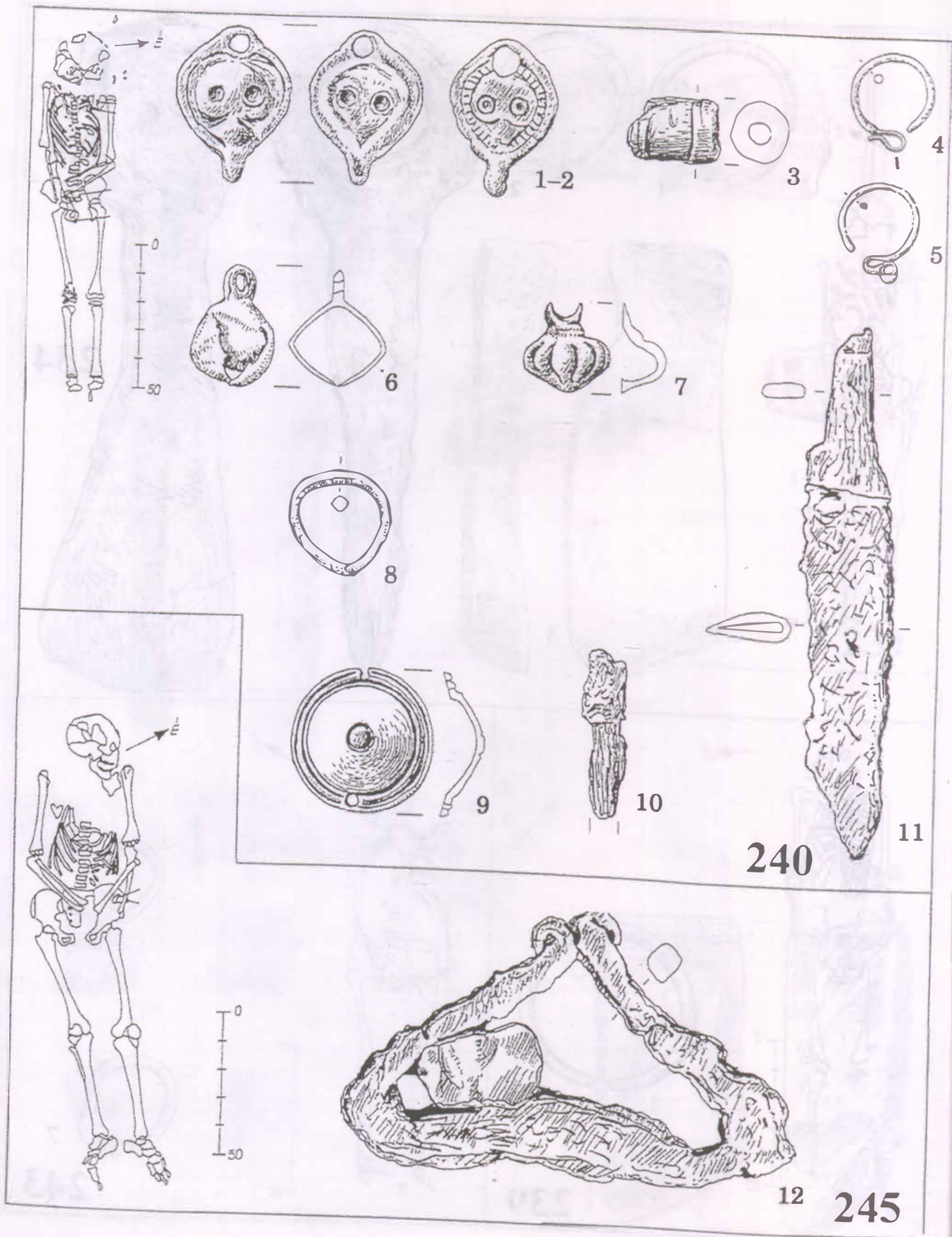

98. tábla: Hajdúszoboszló-Árkoshalom. 240., 245. sír (1:1)

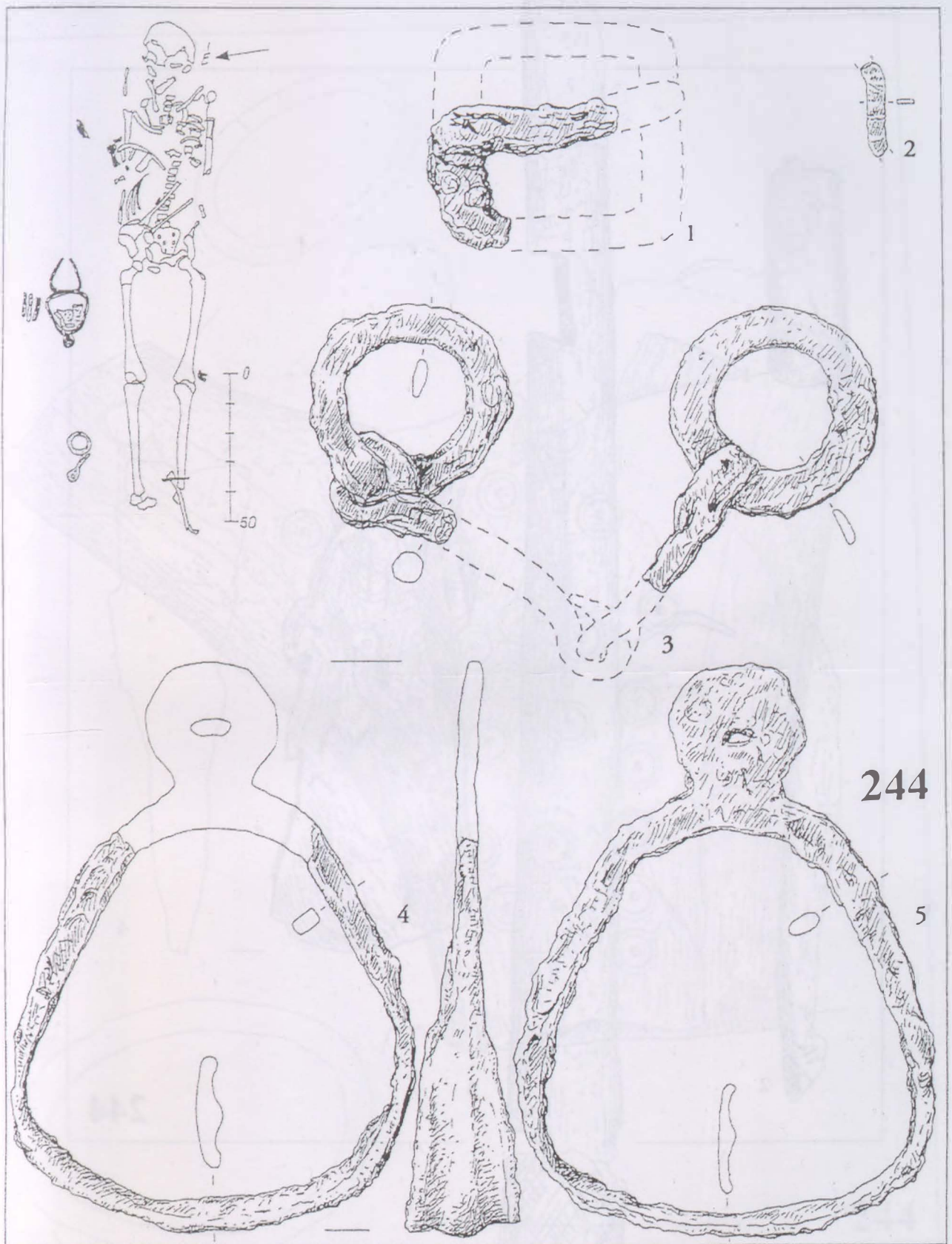

99. tábla: Hajdúszoboszló-Árkoshalom. 244. sír (1., 4. 1:1; 2-3. 1:2)



100. tábla: Hajdúszoboszló-Árkoshalom. 244. sír (1:1)

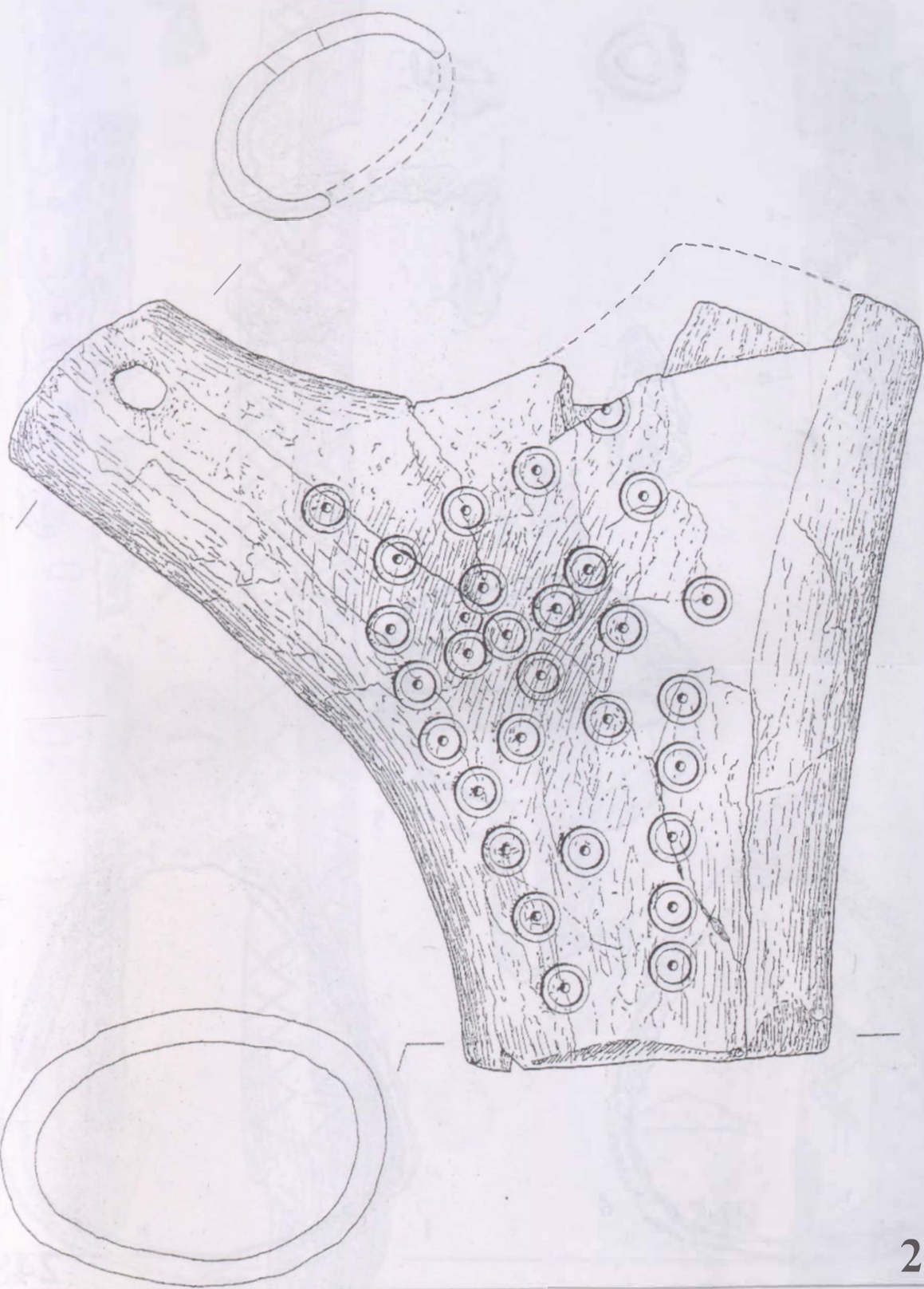

244

101. tábla: Hajdúszoboszló-Árkoshalom. 244. sír (1:1)

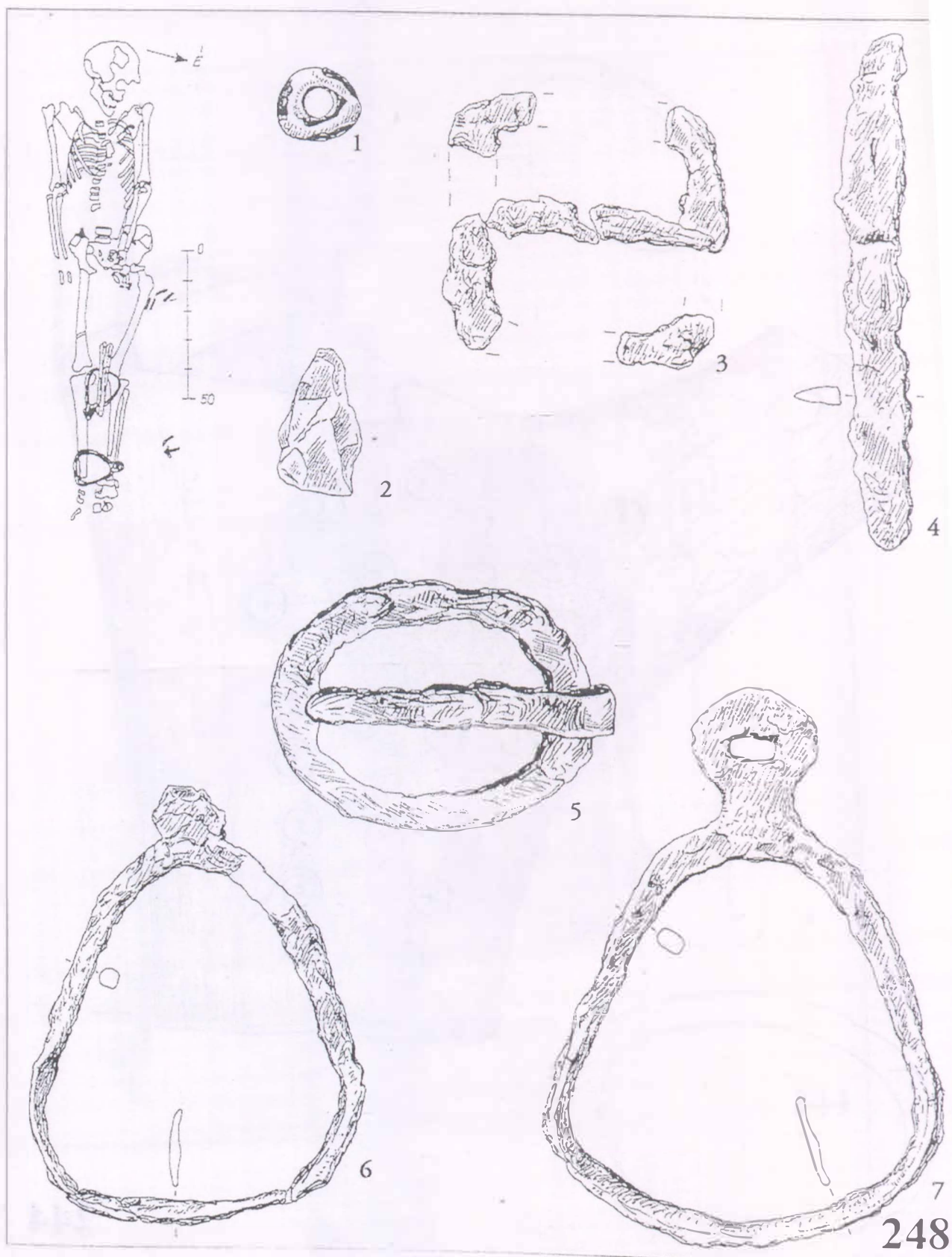

248

102. tábla: Hajdúszoboszló-Árkoshalom. 248. sír (1-5. 1:1; 6-7. 1:2)

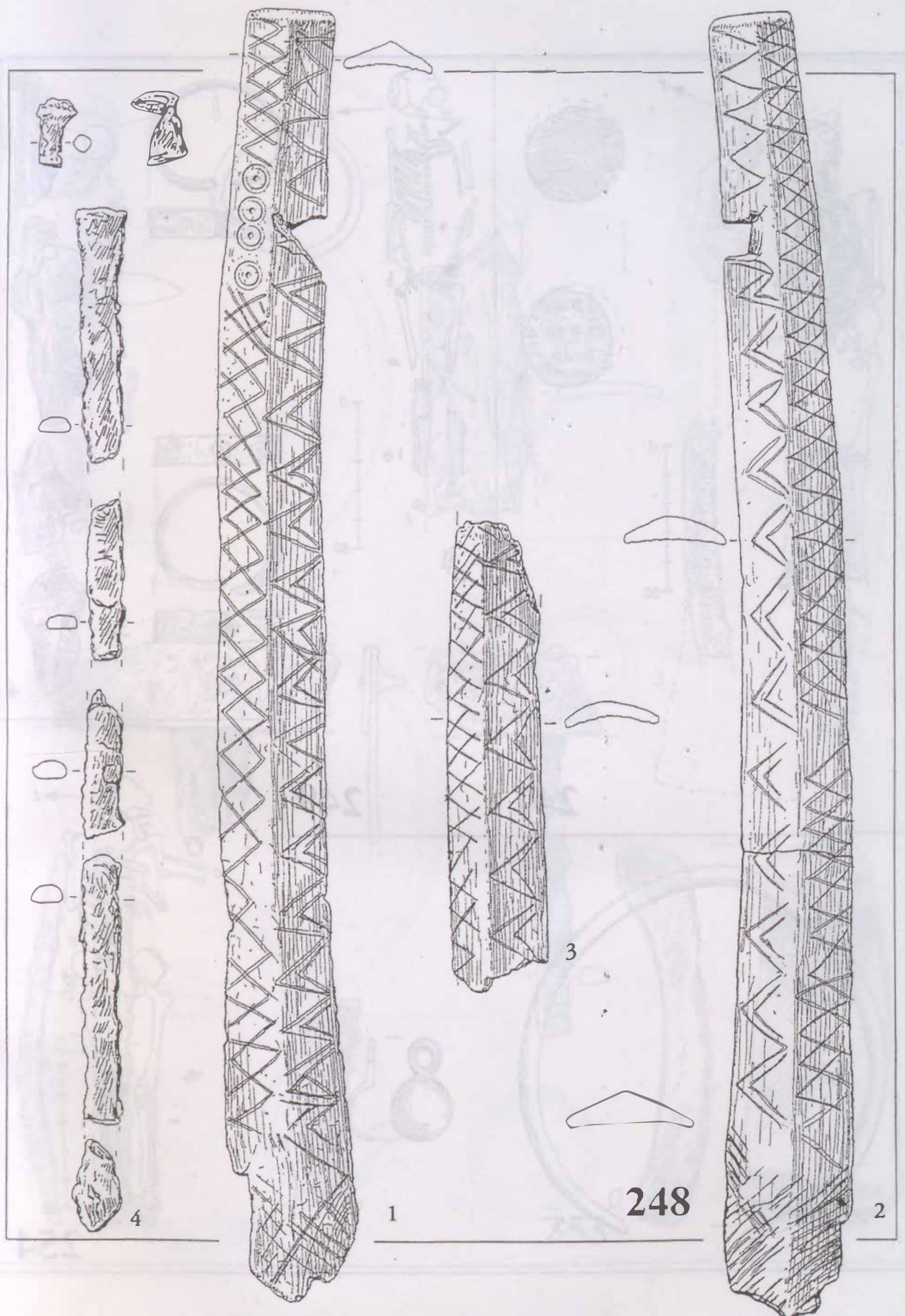

103. tábla: Hajdúszoboszló-Árkoshalom. 248. sír (1:1)

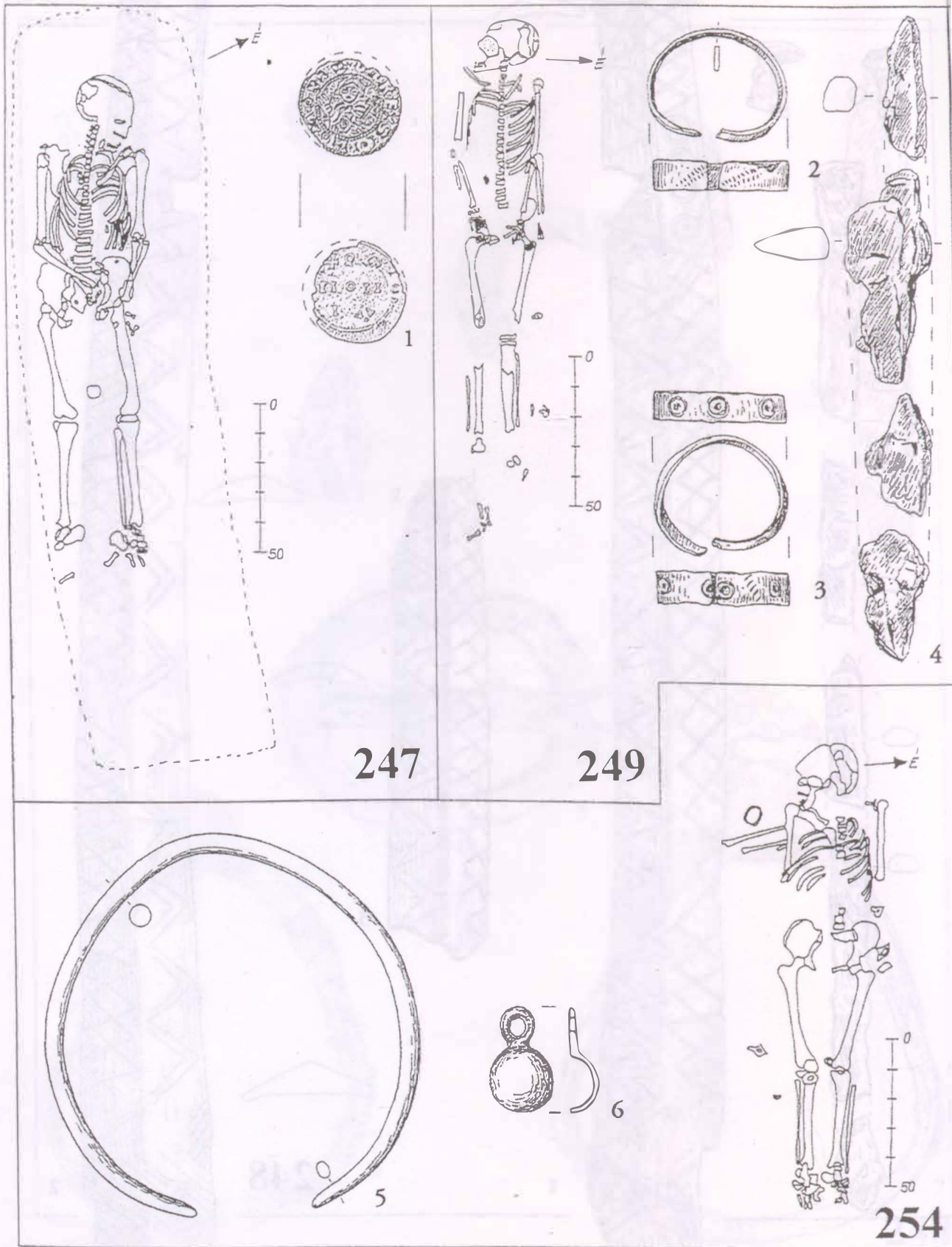

104. tábla: Hajdúszoboszló-Árkoshalom. 247., 249., 254. sír (1:1)

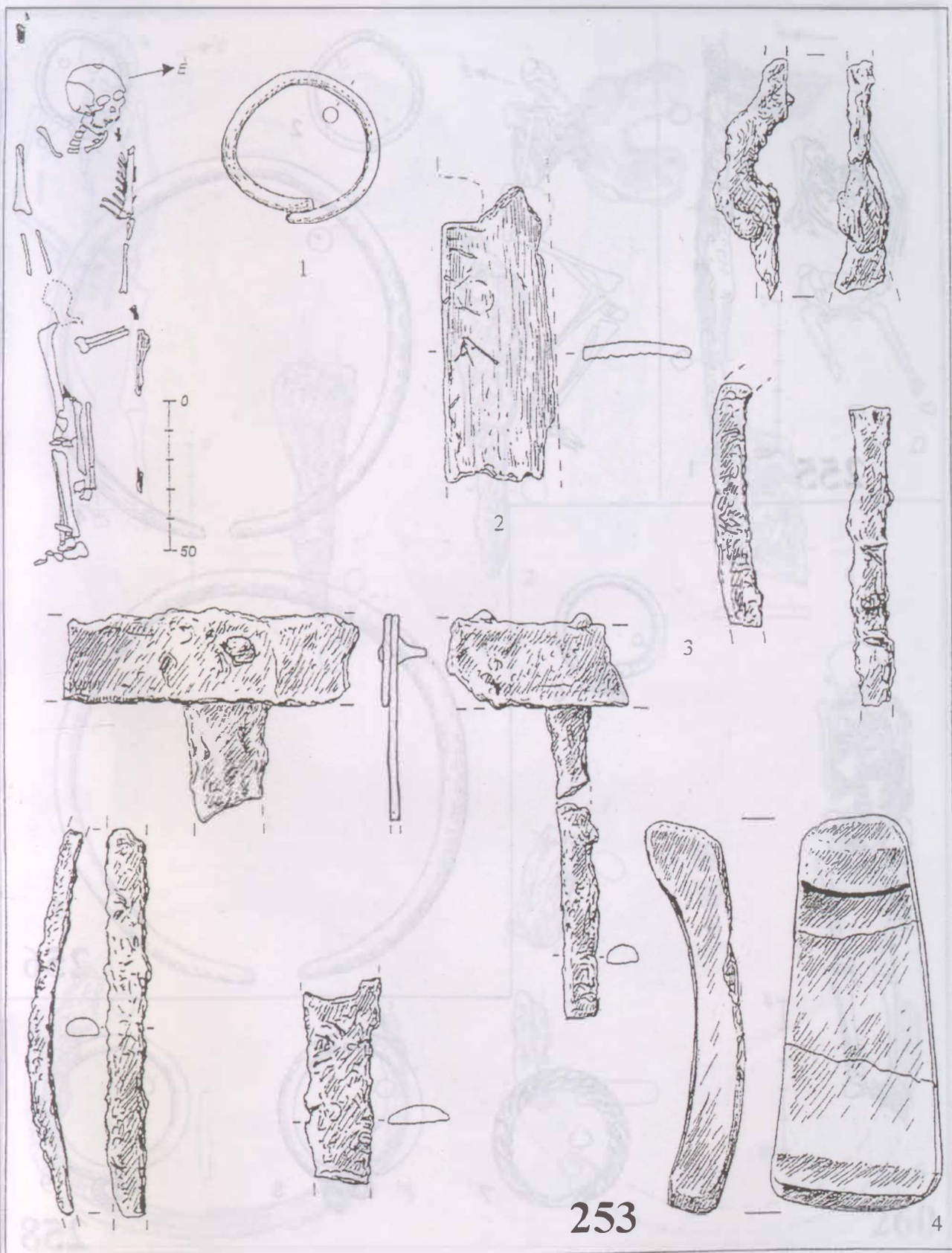

105. tábla: Hajdúszoboszló-Árkoshalom. 253. sír (1:1)

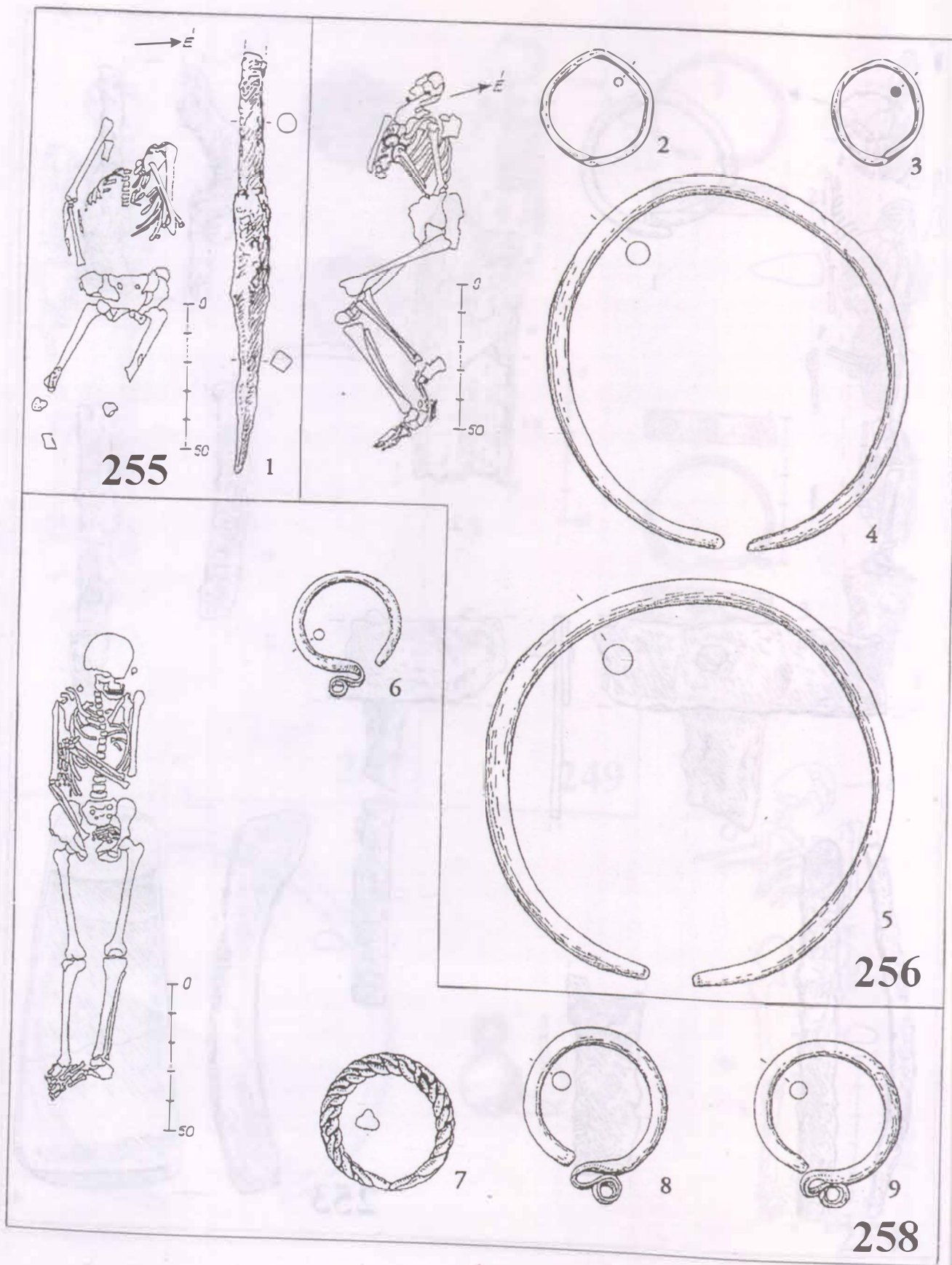

106. tábla: Hajdúszoboszló-Árkoshalom. 255–256., 258. sír (1:1)

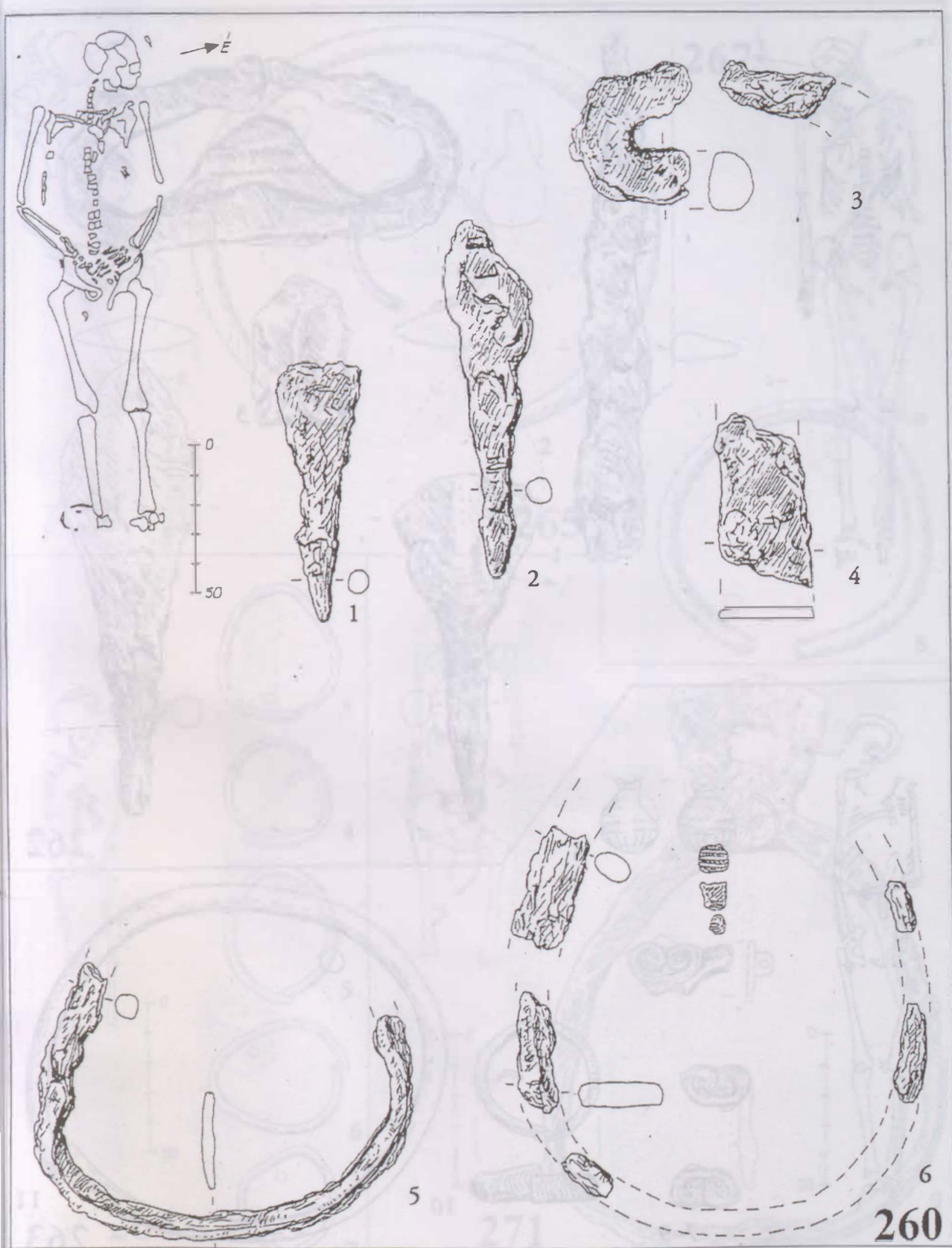

107. tábla: Hajdúszoboszló-Árkoshalom. 260. sír (1-4. 1:1; 5-6. 1:2)

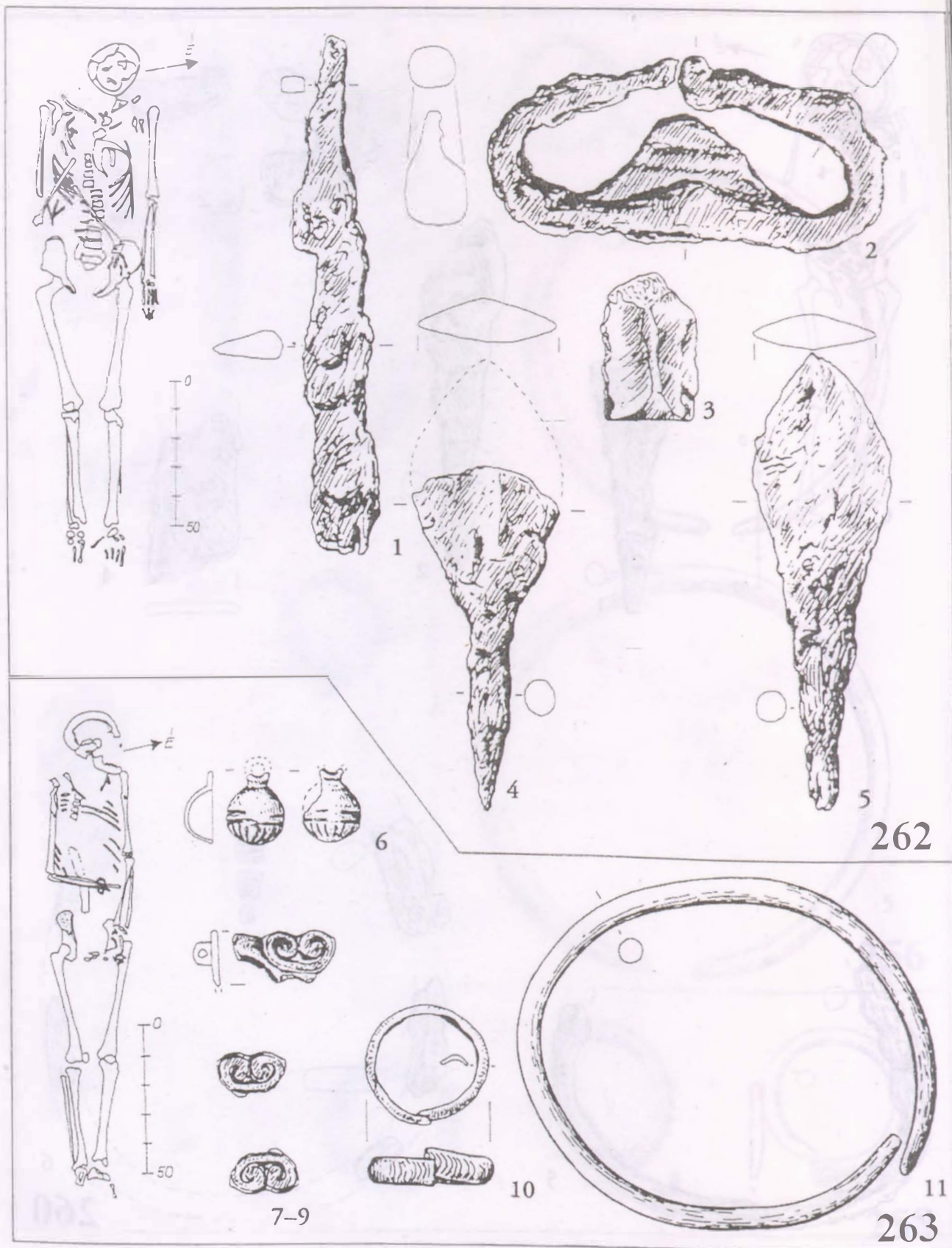

108. tábla: Hajdúszoboszló-Árkoshalom. 262-263. sír (1:1)

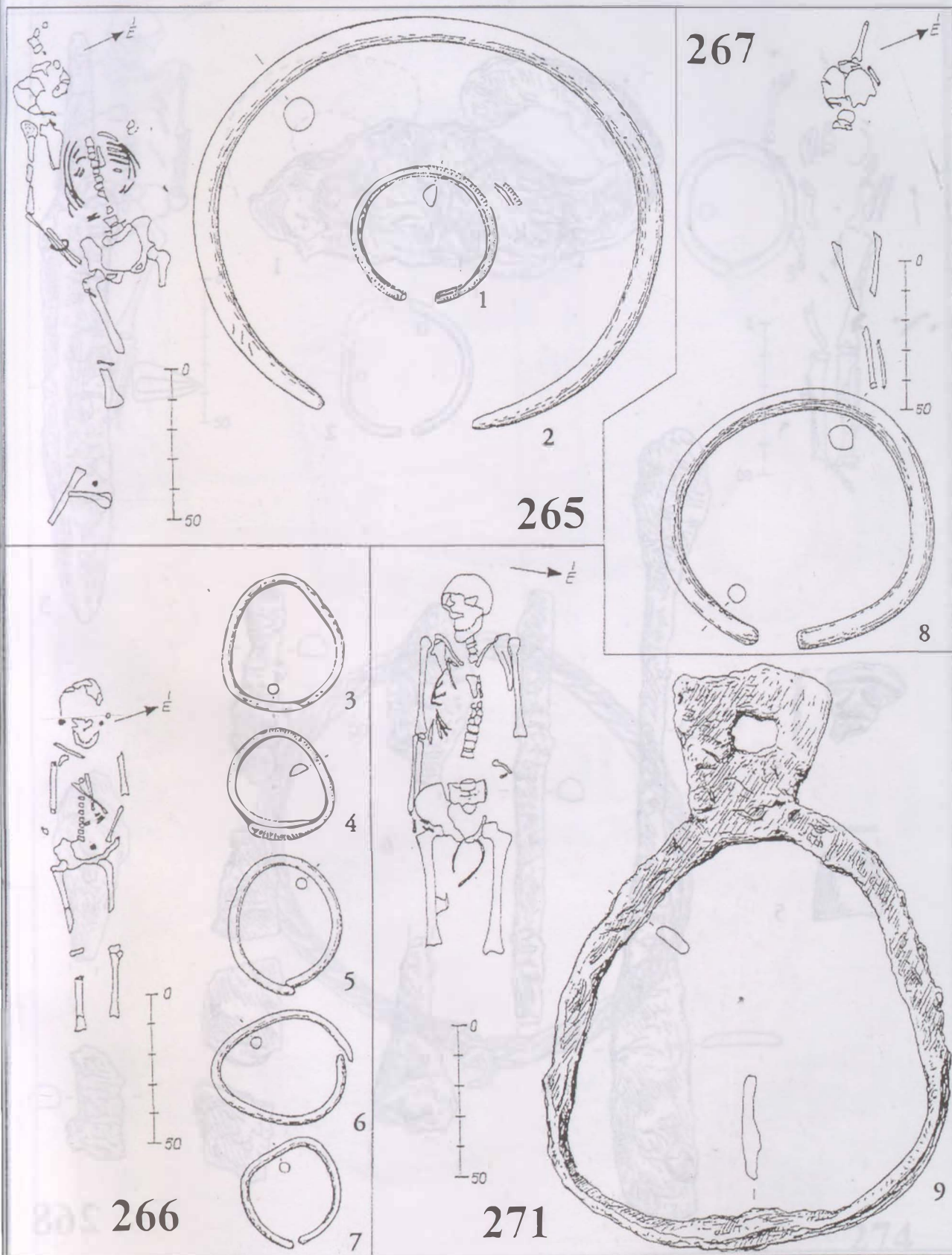

109. tábla: Hajdúszoboszló-Árkoshalom. 265–267., 271. sír (1:1)

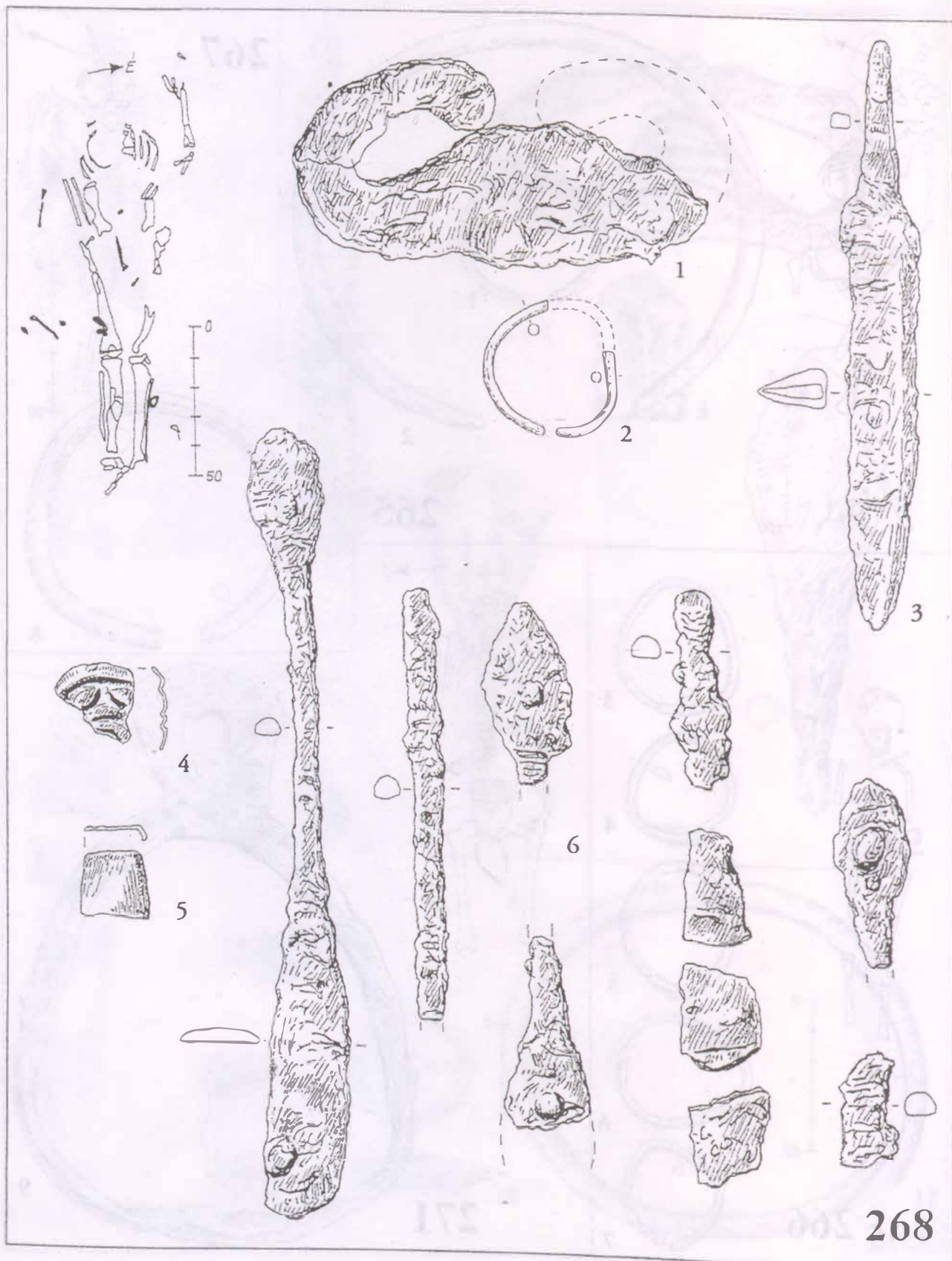

110. tábla: Hajdúszoboszló-Árkoshalom. 268. sír (1:1)

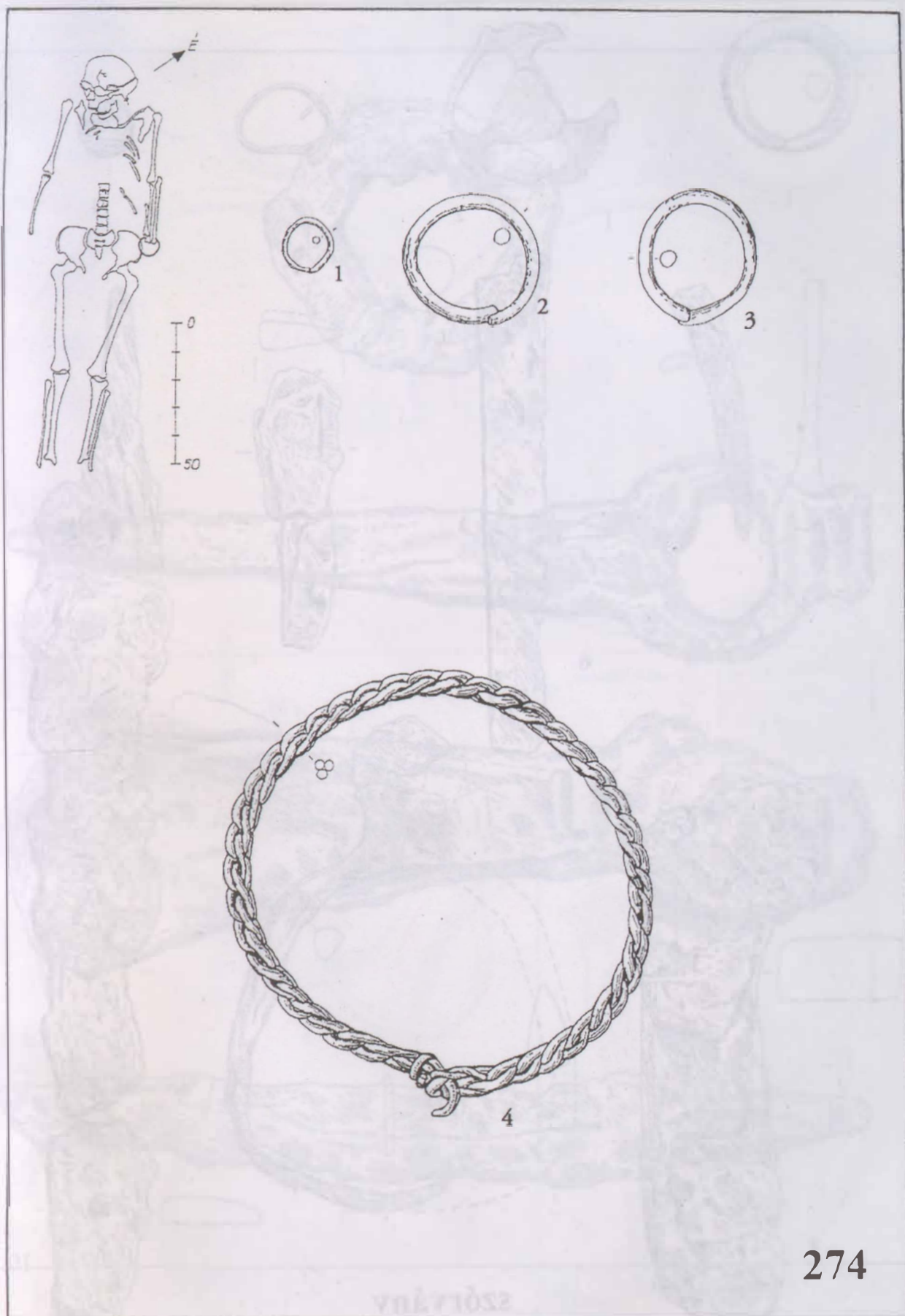

274

111. tábla: Hajdúszoboszló-Árkoshalom. 274. sír (1:1)

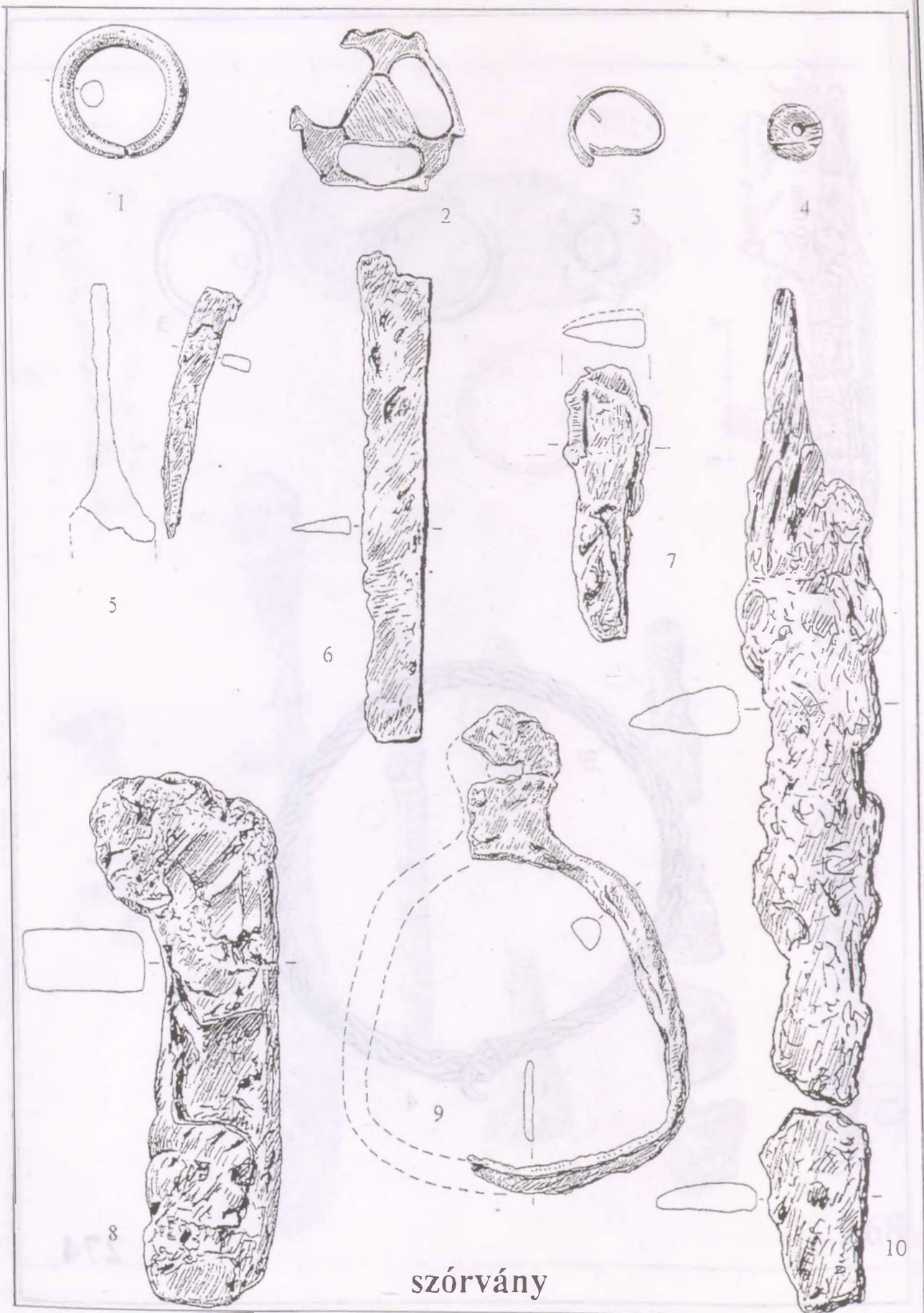

112. tábla: Hajdúszoboszló-Árkoshalom. Szórvány (1-8., 10. 1:1; 9. 1:2)

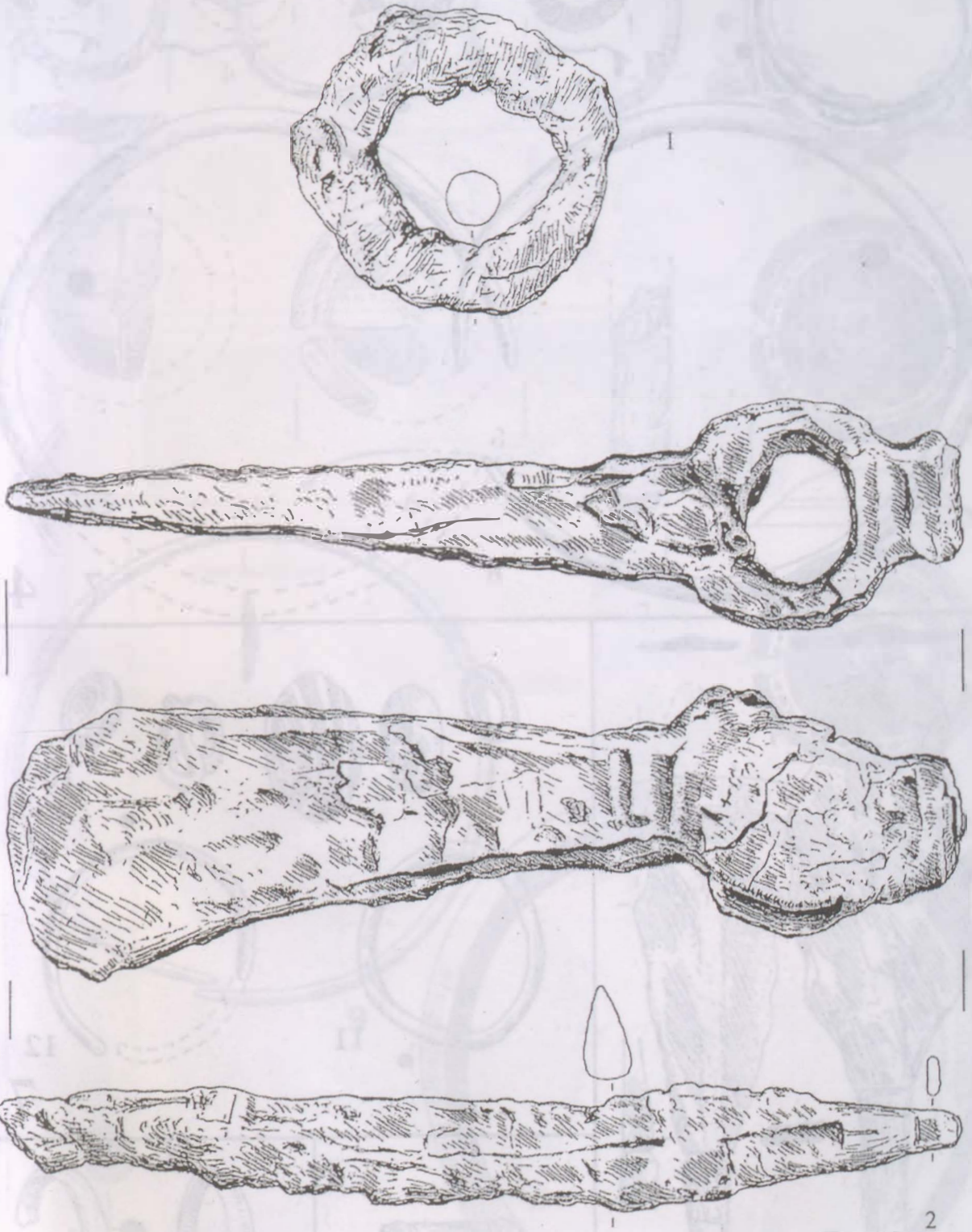

113. Hajdúszoboszló-Bercsényi utca 49. Szórvány (1:1)

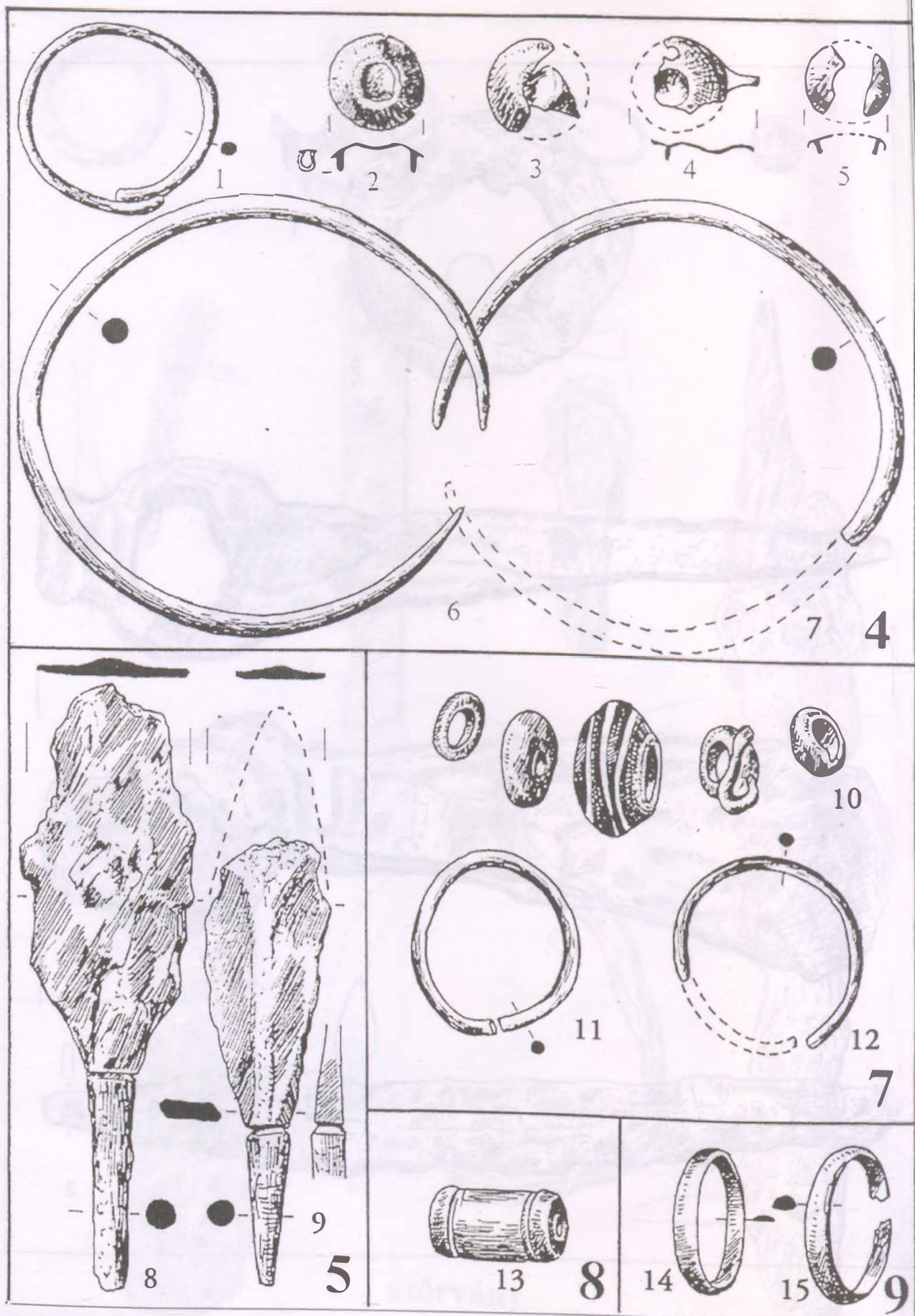

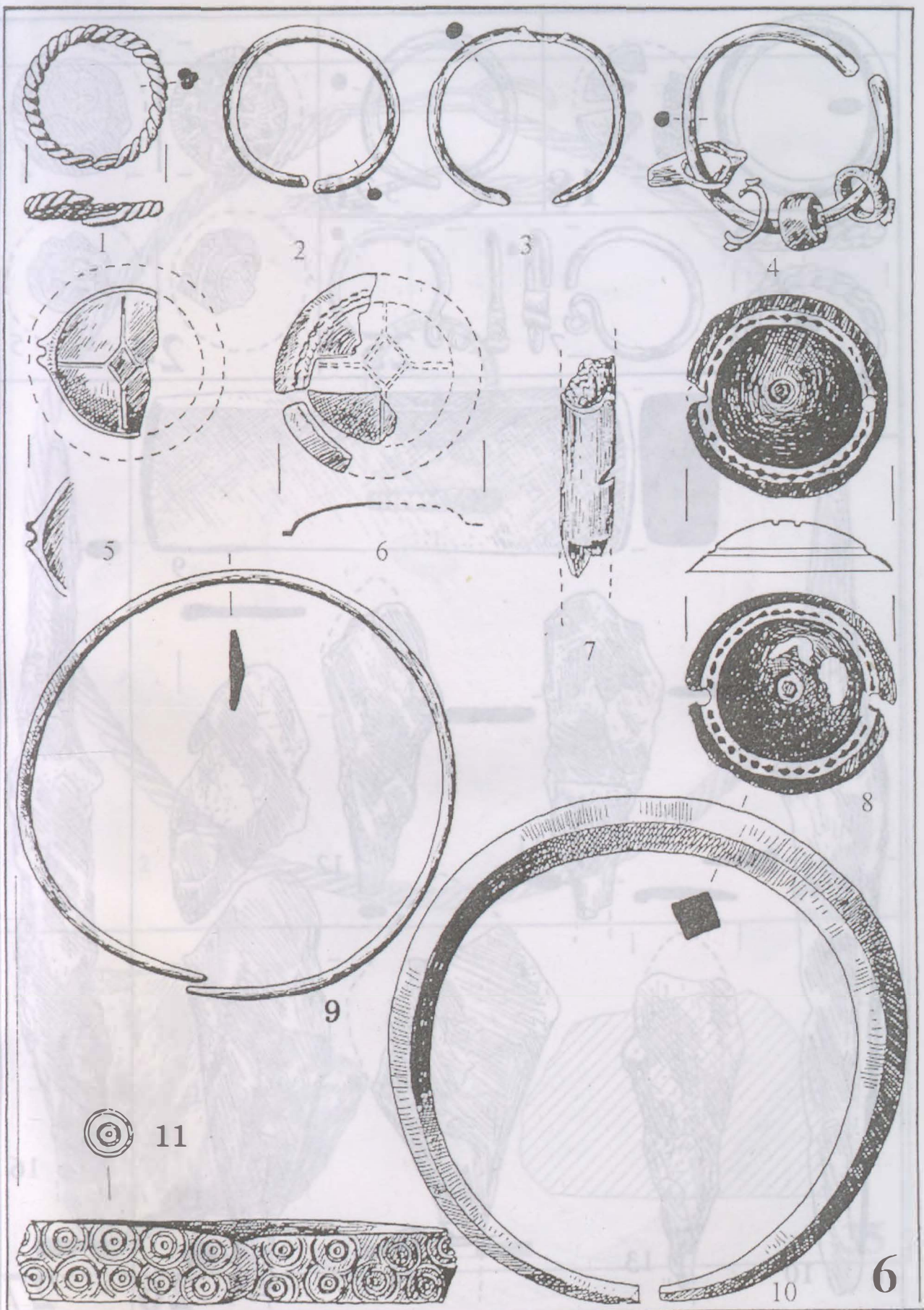

115. tábla: Körösszegapáti-Pállapály. 6. sír (1:1)

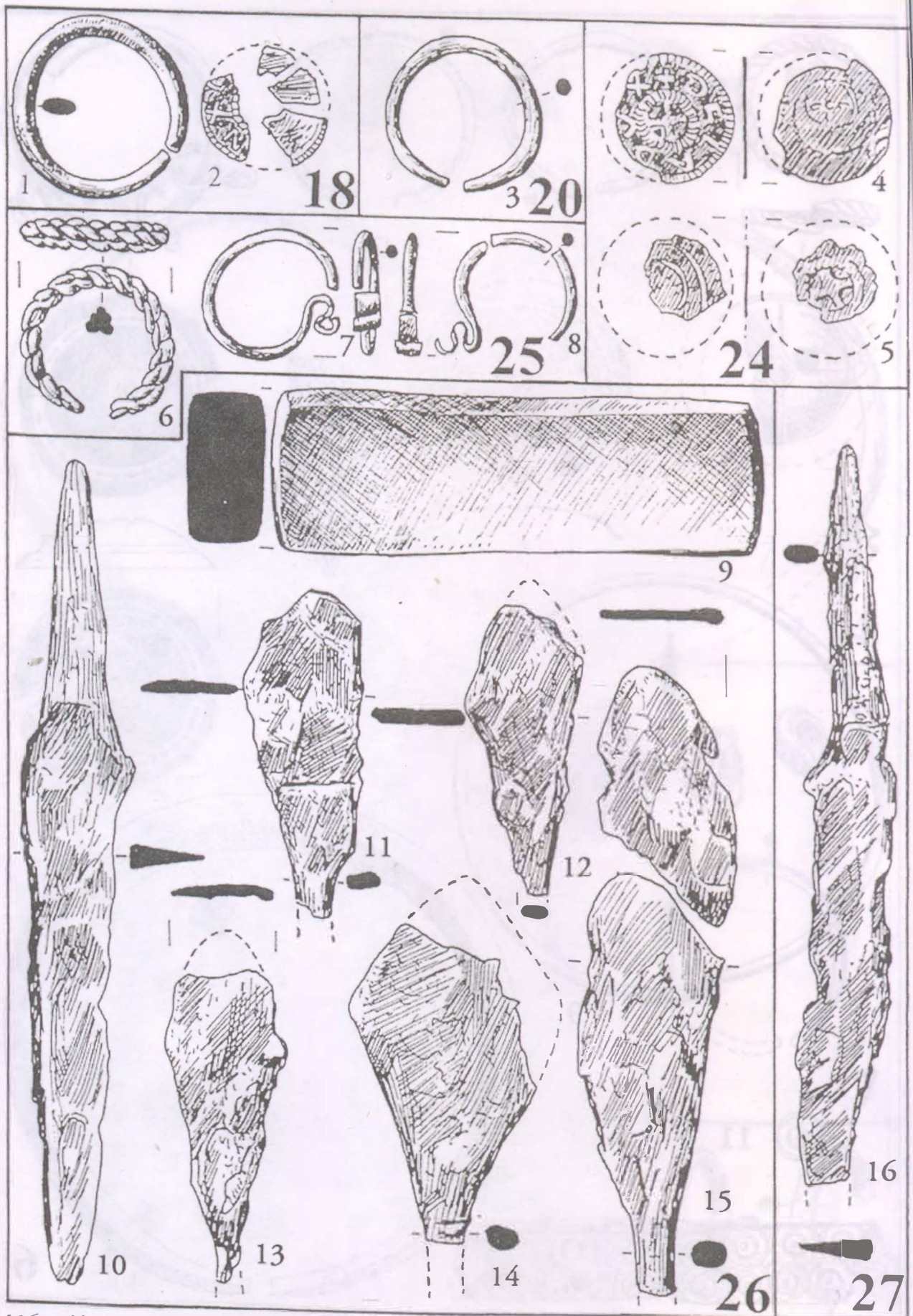

116. tábla: Körösszegapáti-Pállapály. 18., 20., 24-27. sír (1:1)

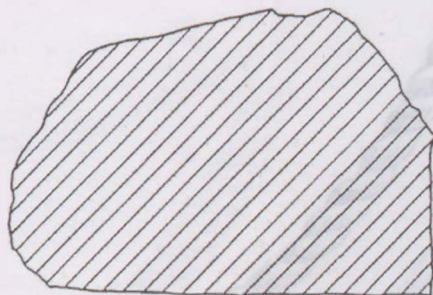
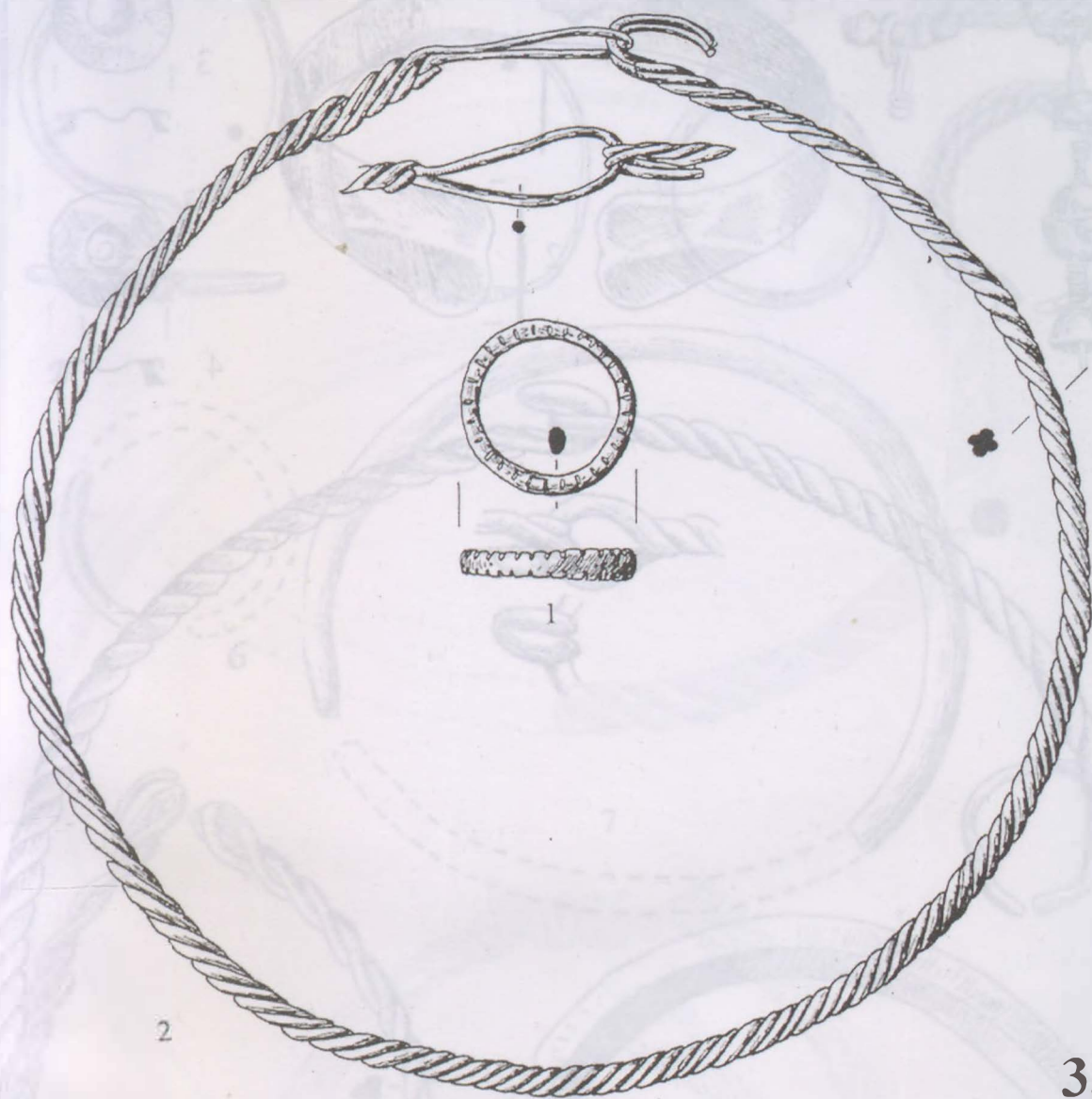

117. tábla: Körösszegapáti-Pállapály. 33., 35. sír (1:1)

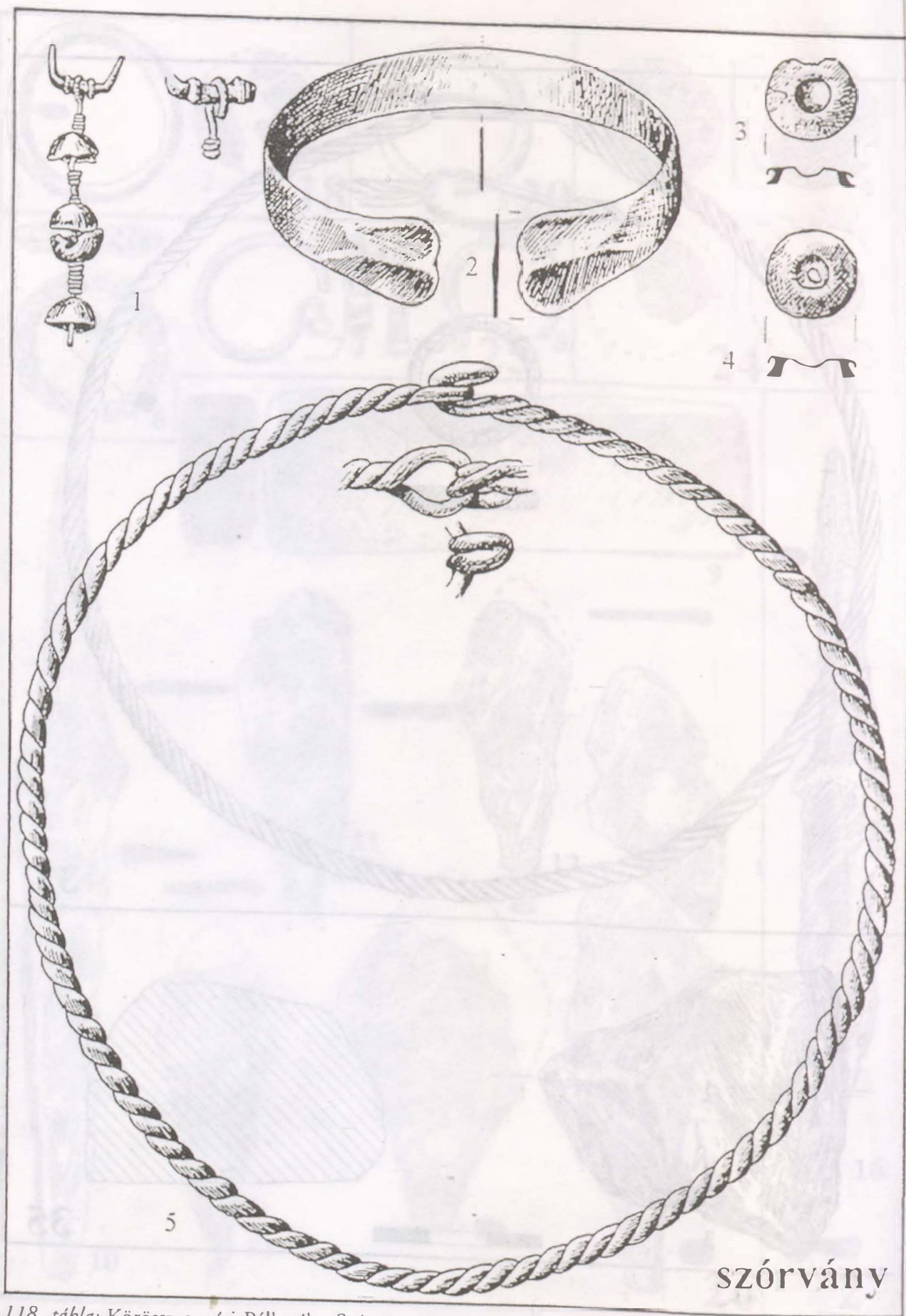

szórvány

118. tábla: Körösszegapáti-Pállapály. Szórvány (1:1)

szórvány

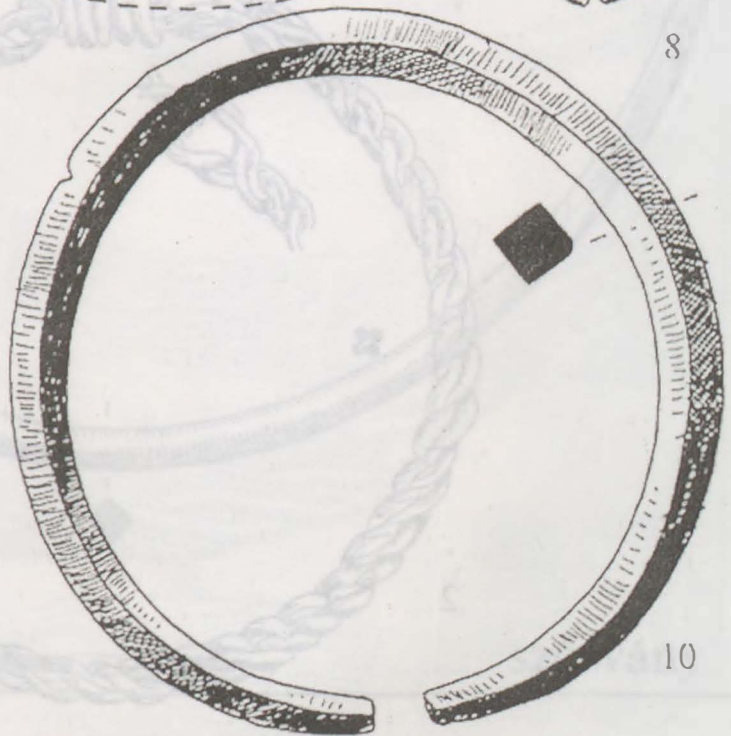
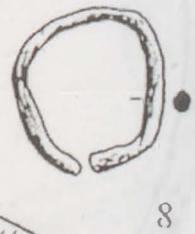
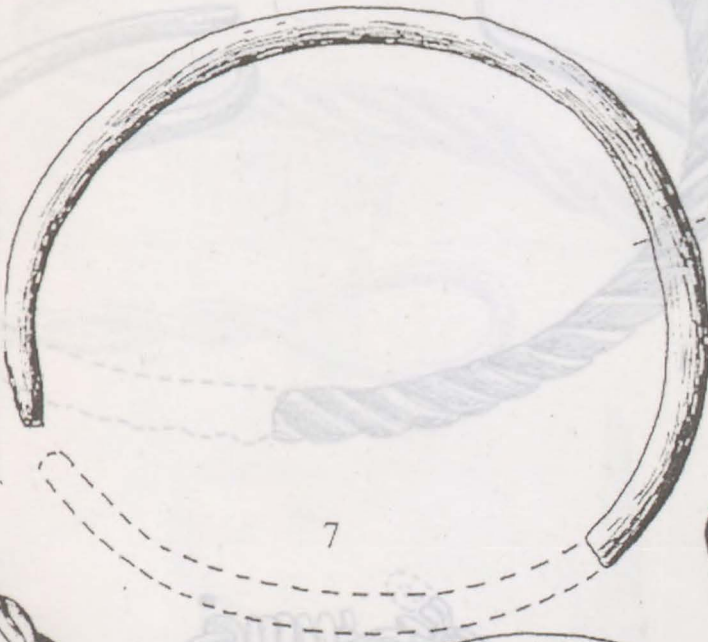
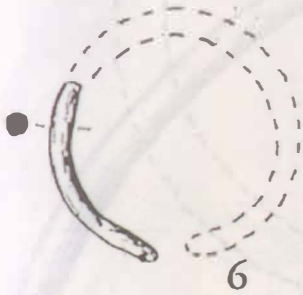
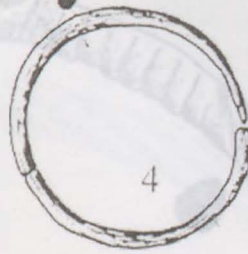
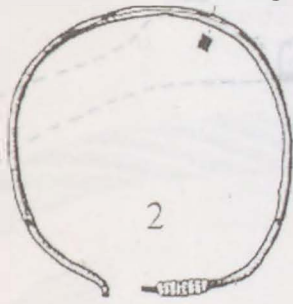
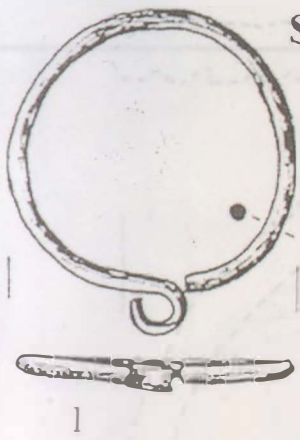

119. tábla: Körösszegapáti-Pállapály. Szórvány (1:1)

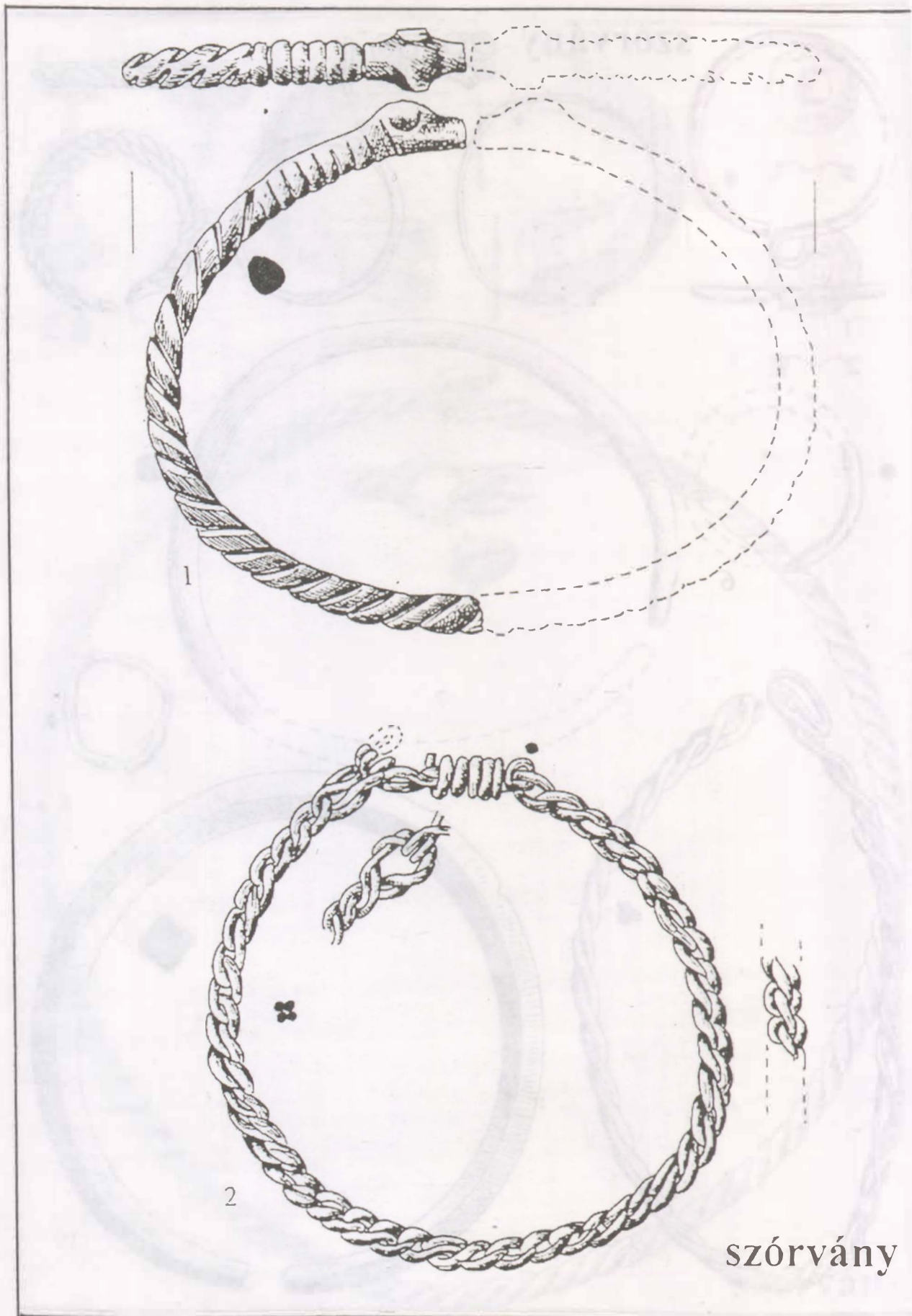

szórvány

120. tábla: Körösszegapáti-Pállapály. Szórvány (1:1)

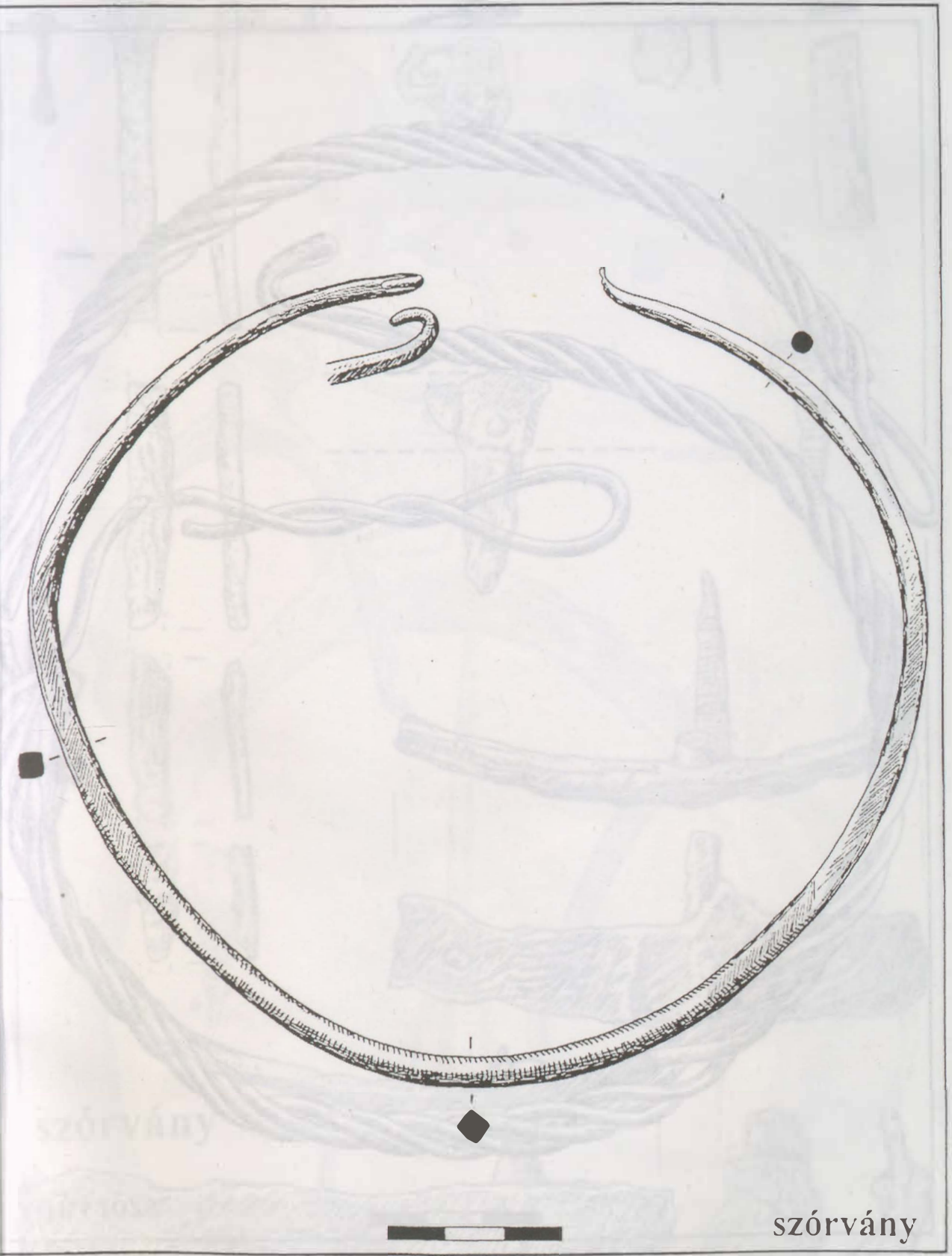

21. tábla: Körösszegapáti-Pállapály. Szórvány (1:1)

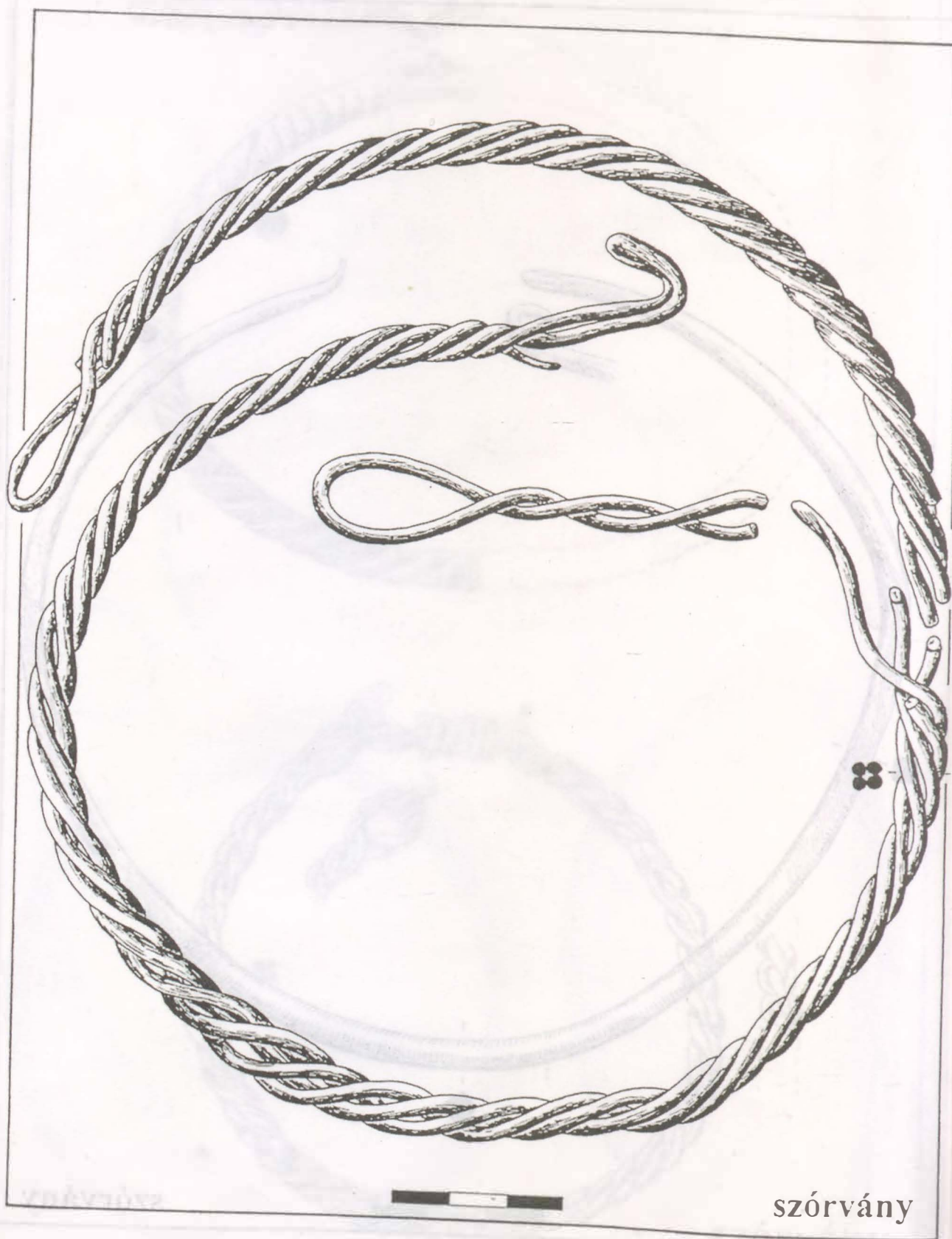

szórvány

122. tábla: Körösszegapáti-Pállapály. Szórvány (1:1)

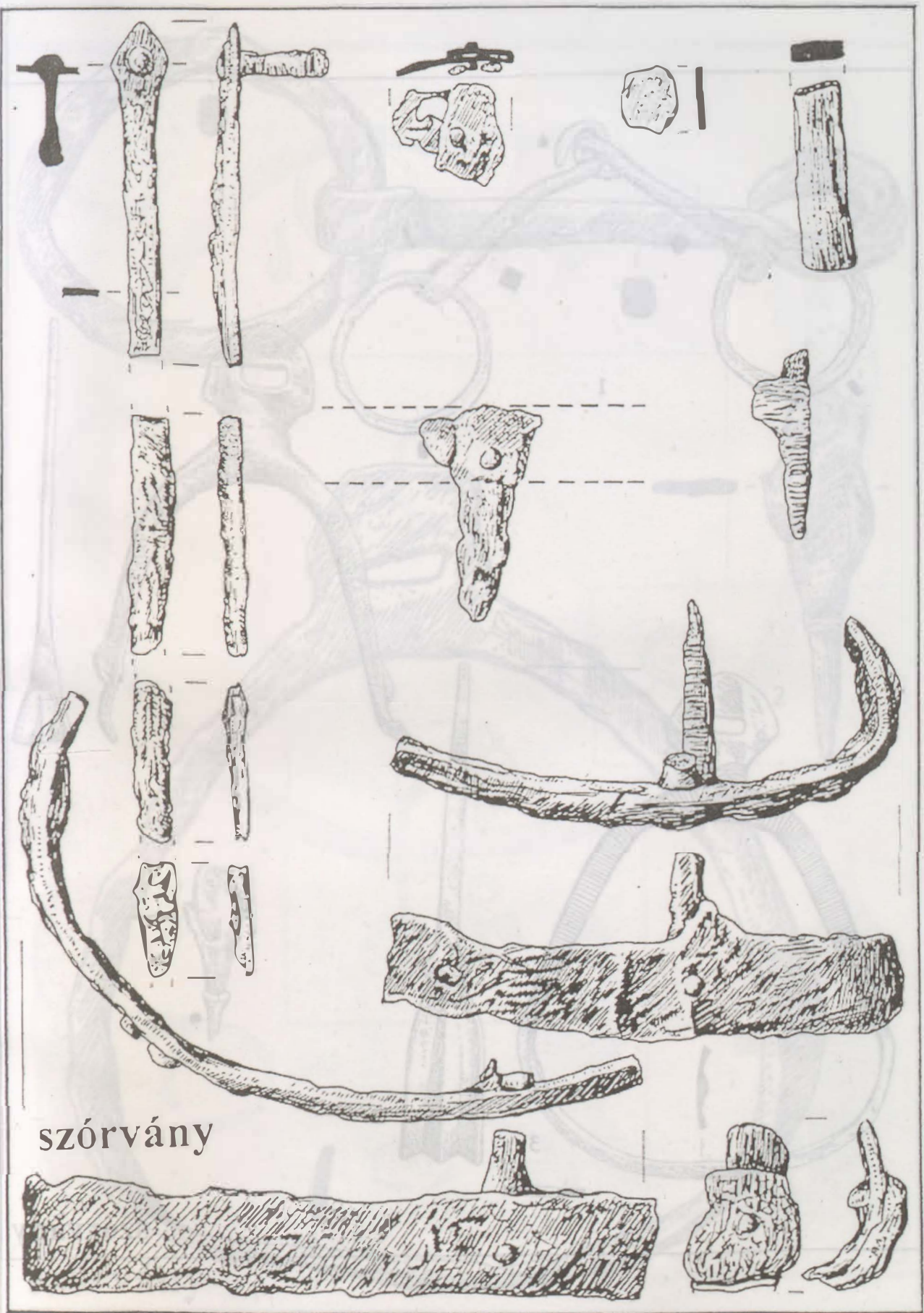

szórvány

123. tábla: Körösszegapáti-Pállapály. Szórvány (1:1)

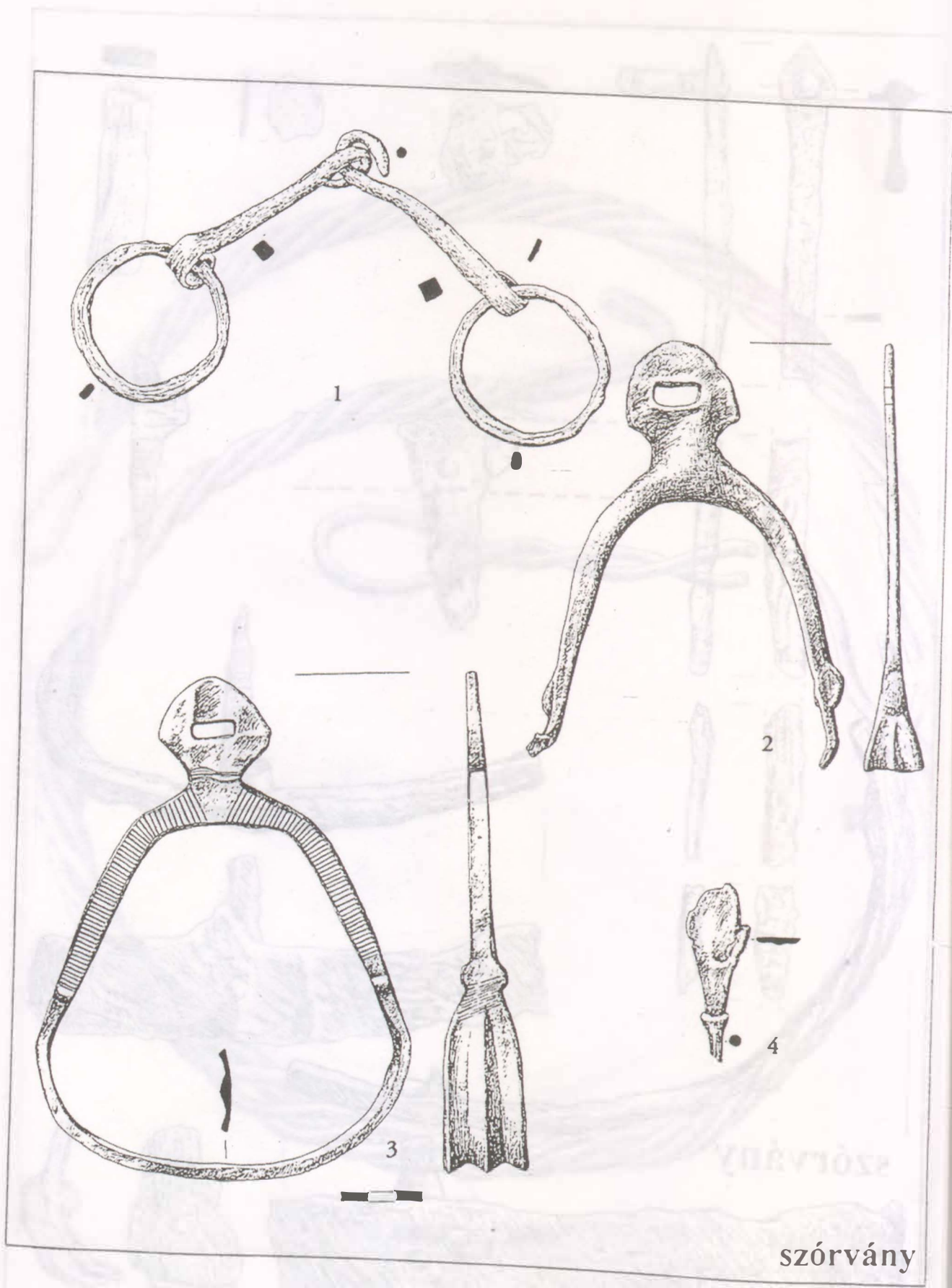

szórvány

124. tábla: Körösszegapáti-Pállapály. Szórvány (1:2)

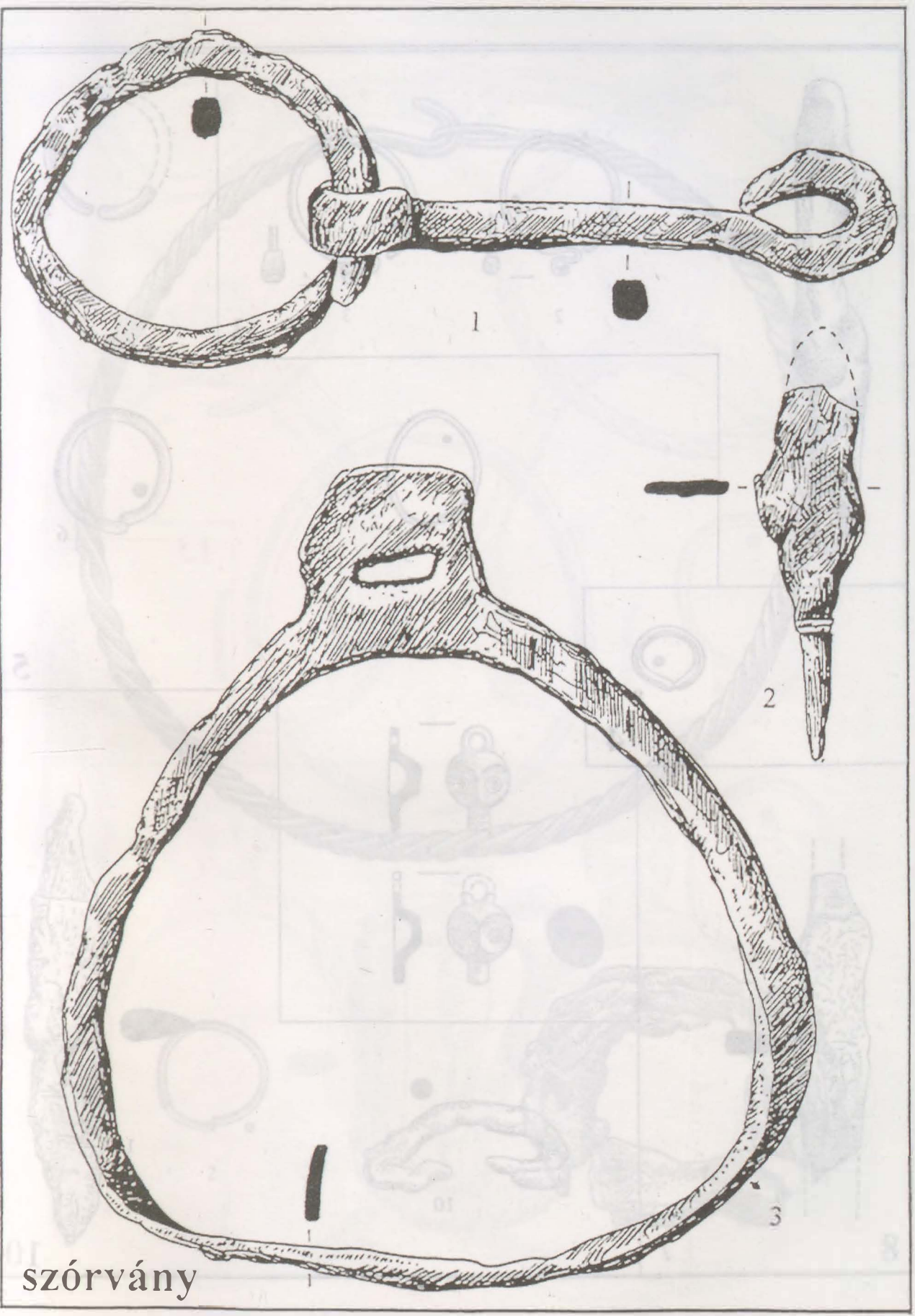

szórvány

125. tábla: Körösszegapáti-Pállapály. Szórvány (1:1)

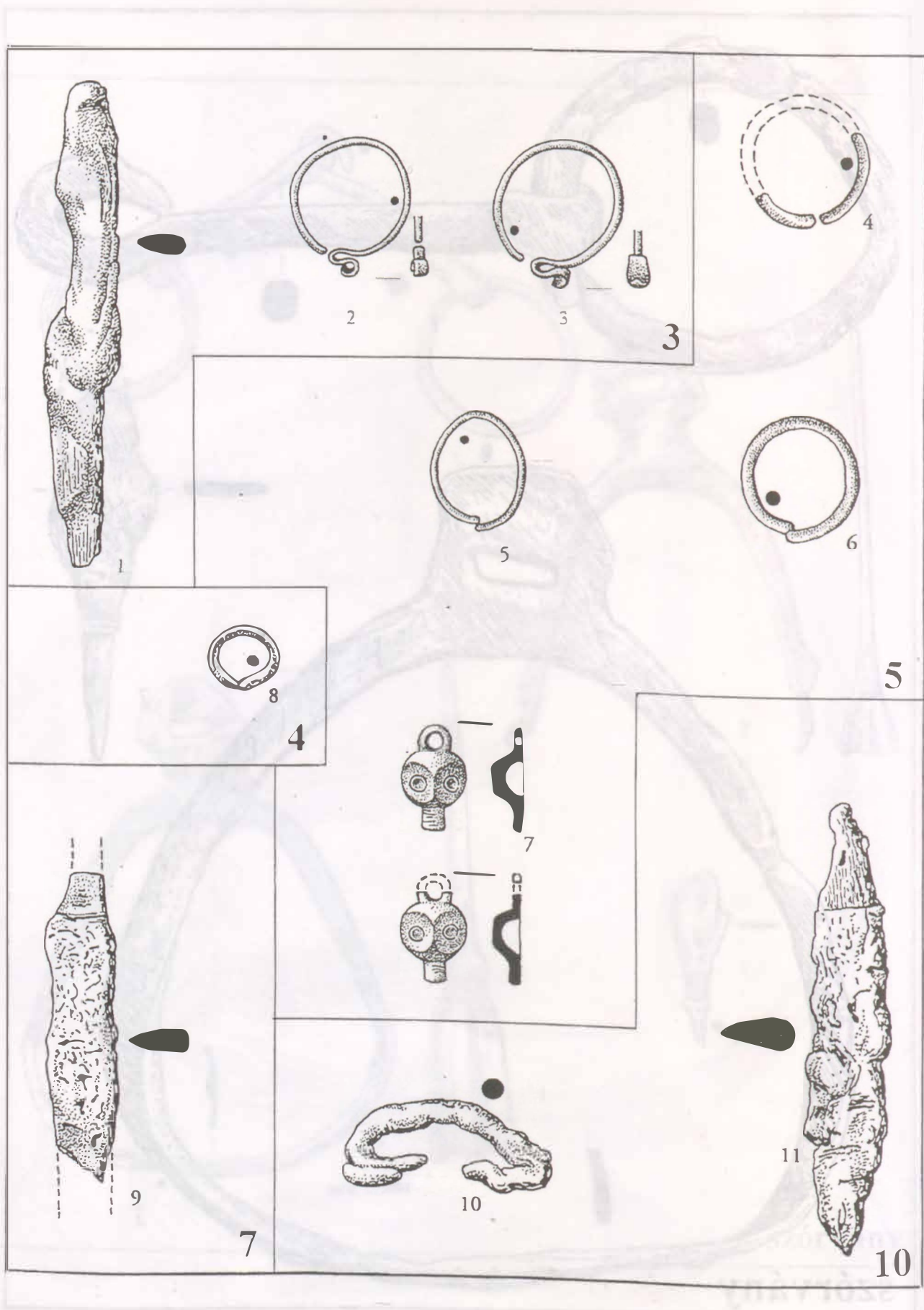

126. tábla: Püspökladány-Eperjesvölgy. 3-5., 7., 10. sír (1:1)



8

127. tábla: Püspökladány-Eperjesvölgy. 8. sír (1:1)

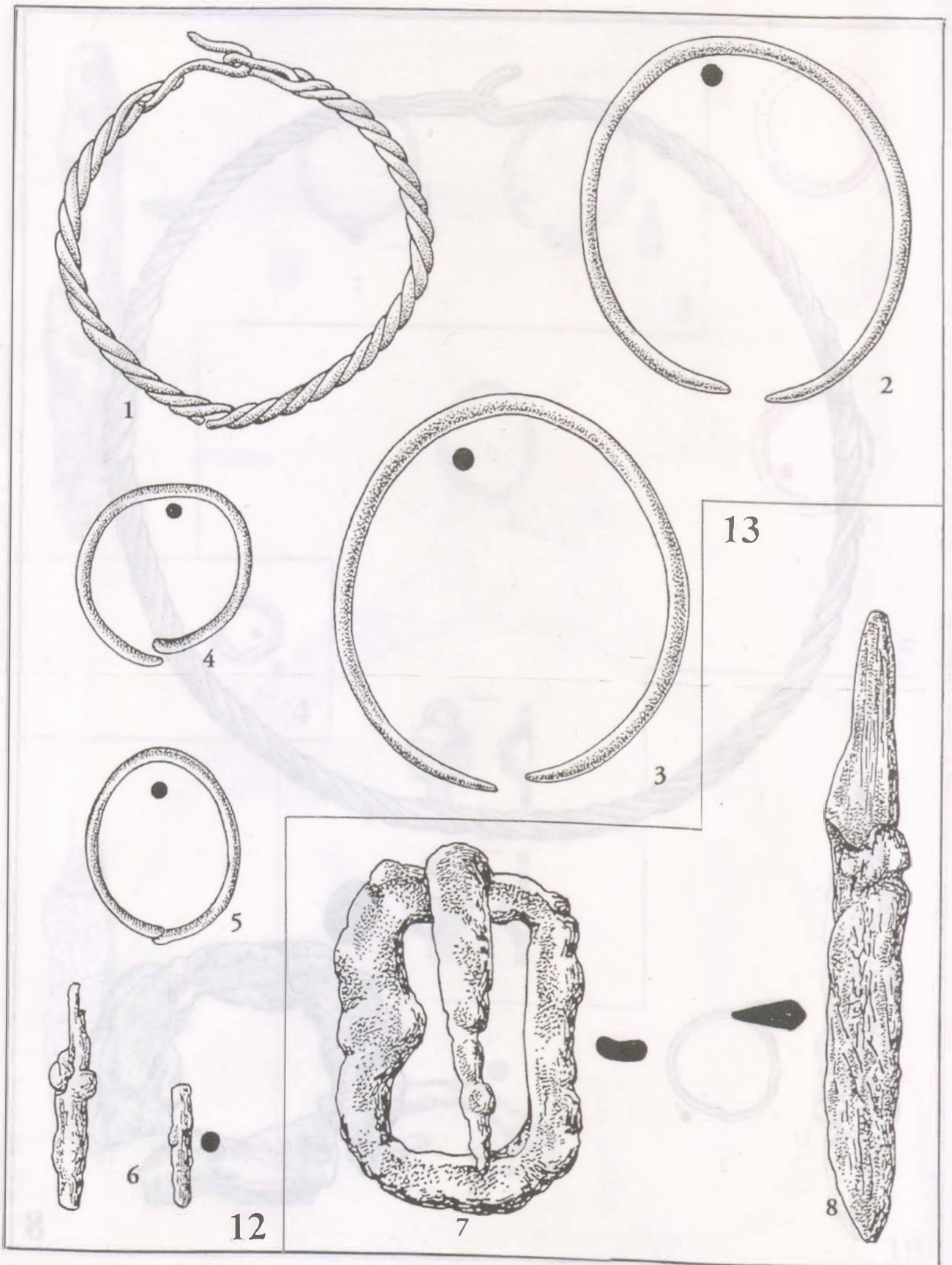

128. tábla: Püspökladány-Eperjesvölgy. 12-13. sír (1:1)

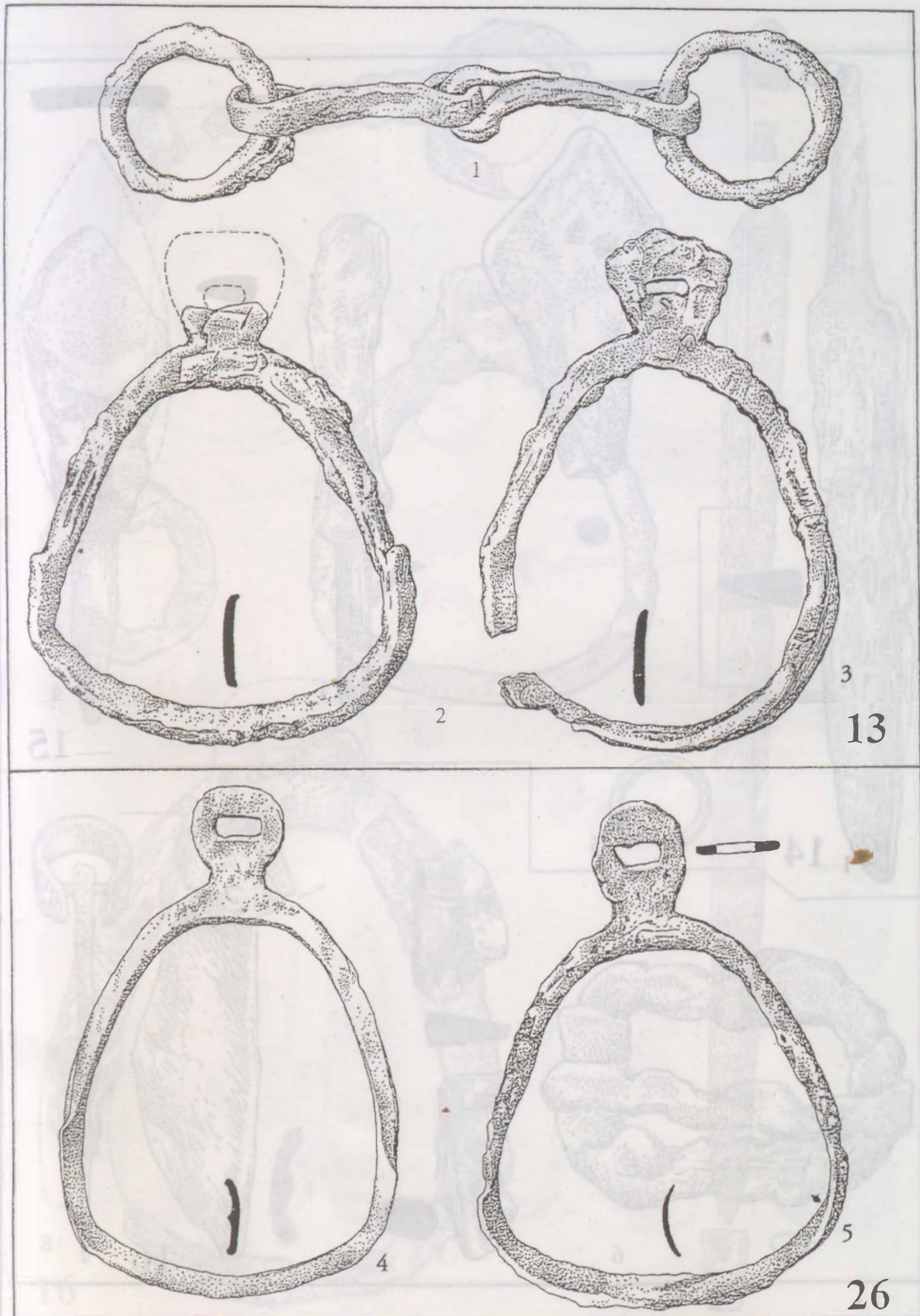

129. tábla: Püspökladány-Eperjesvölgy. 13., 26. sír (1:2)

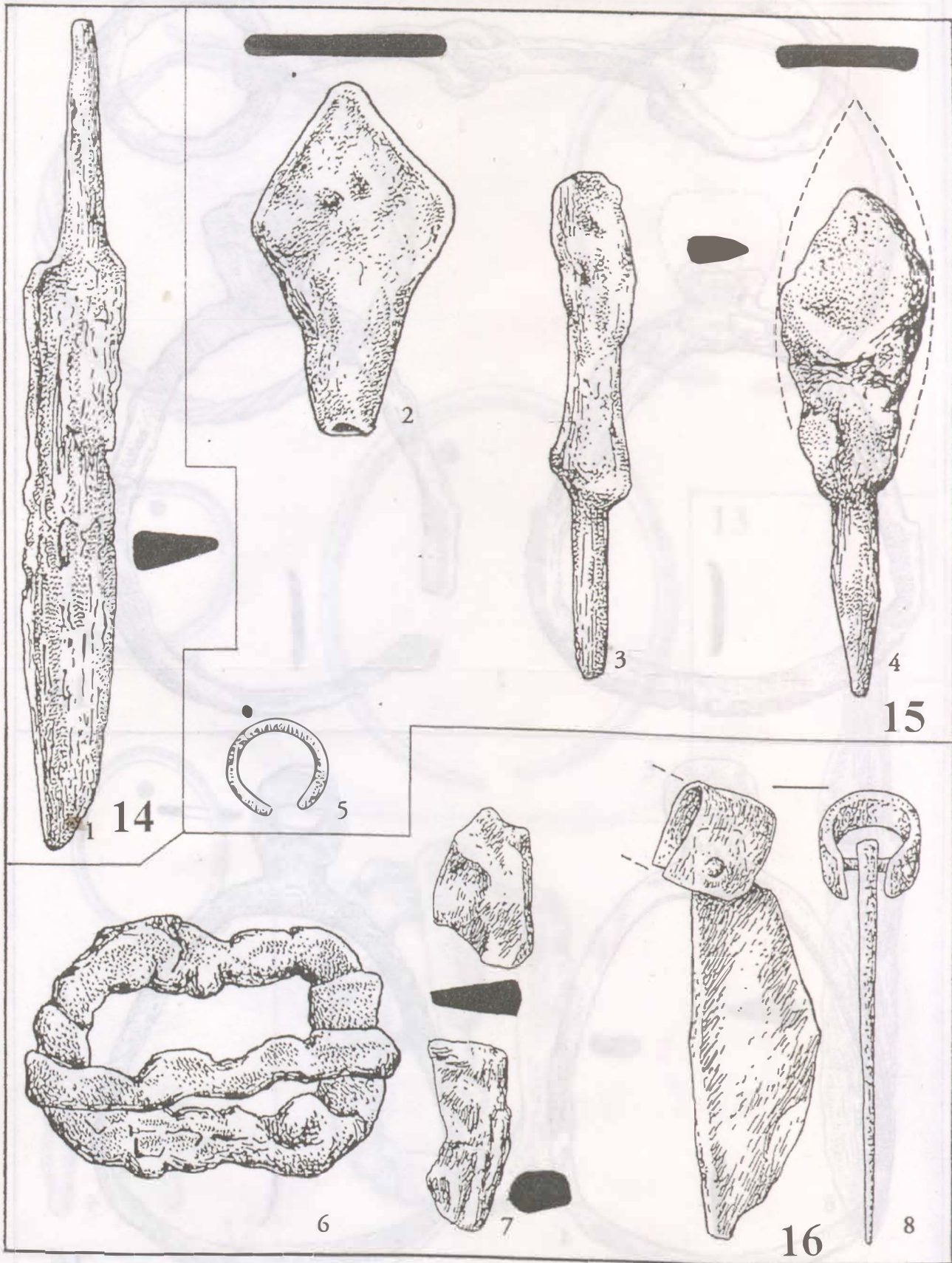

130. tábla: Püspökladány-Eperjesvölgy. 14–16. sír (1:1)

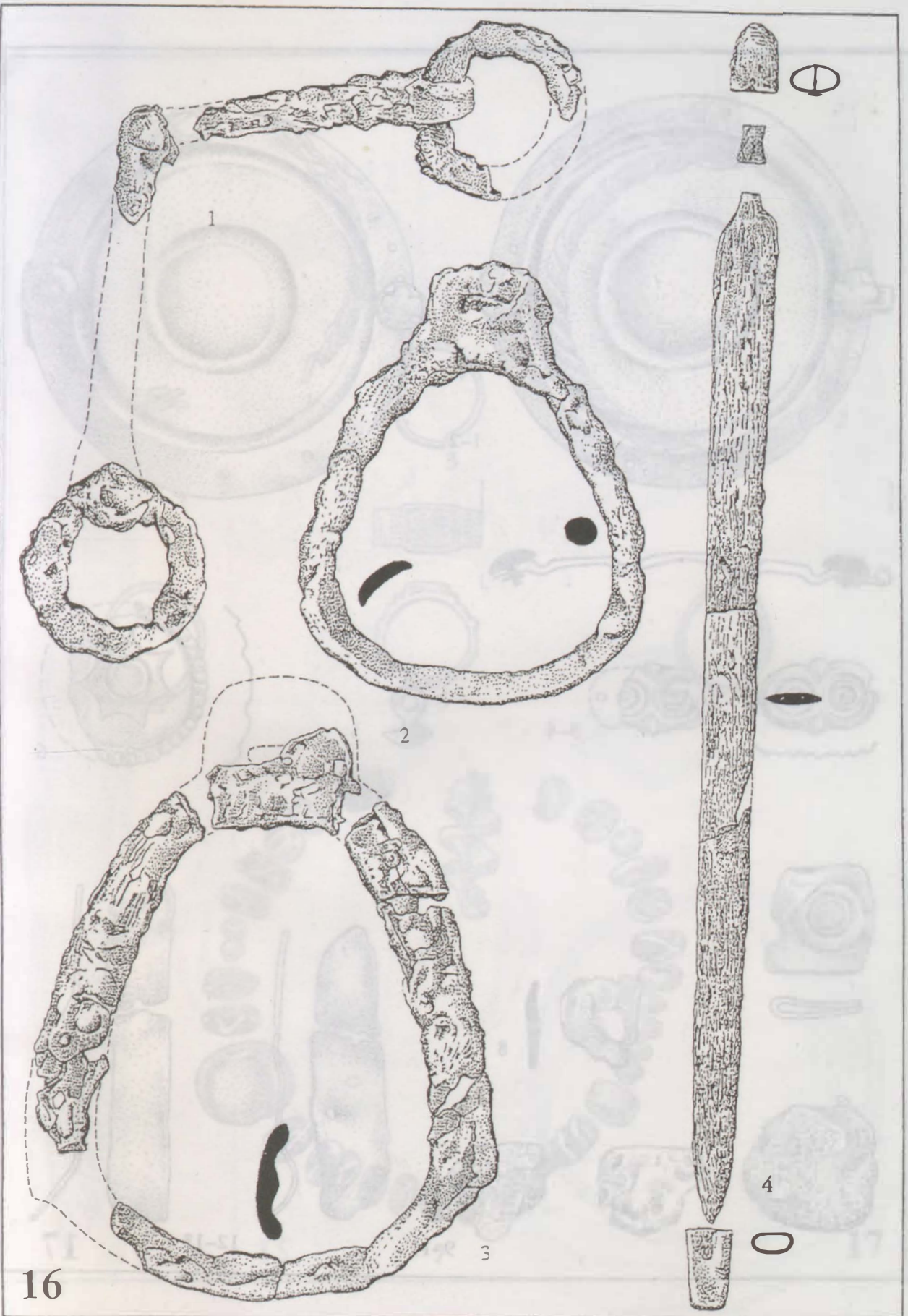

16

131. tábla; Püspökladány-Eperjesvölgy. 16. sír (1-2. 1:2; 3. 1:4)

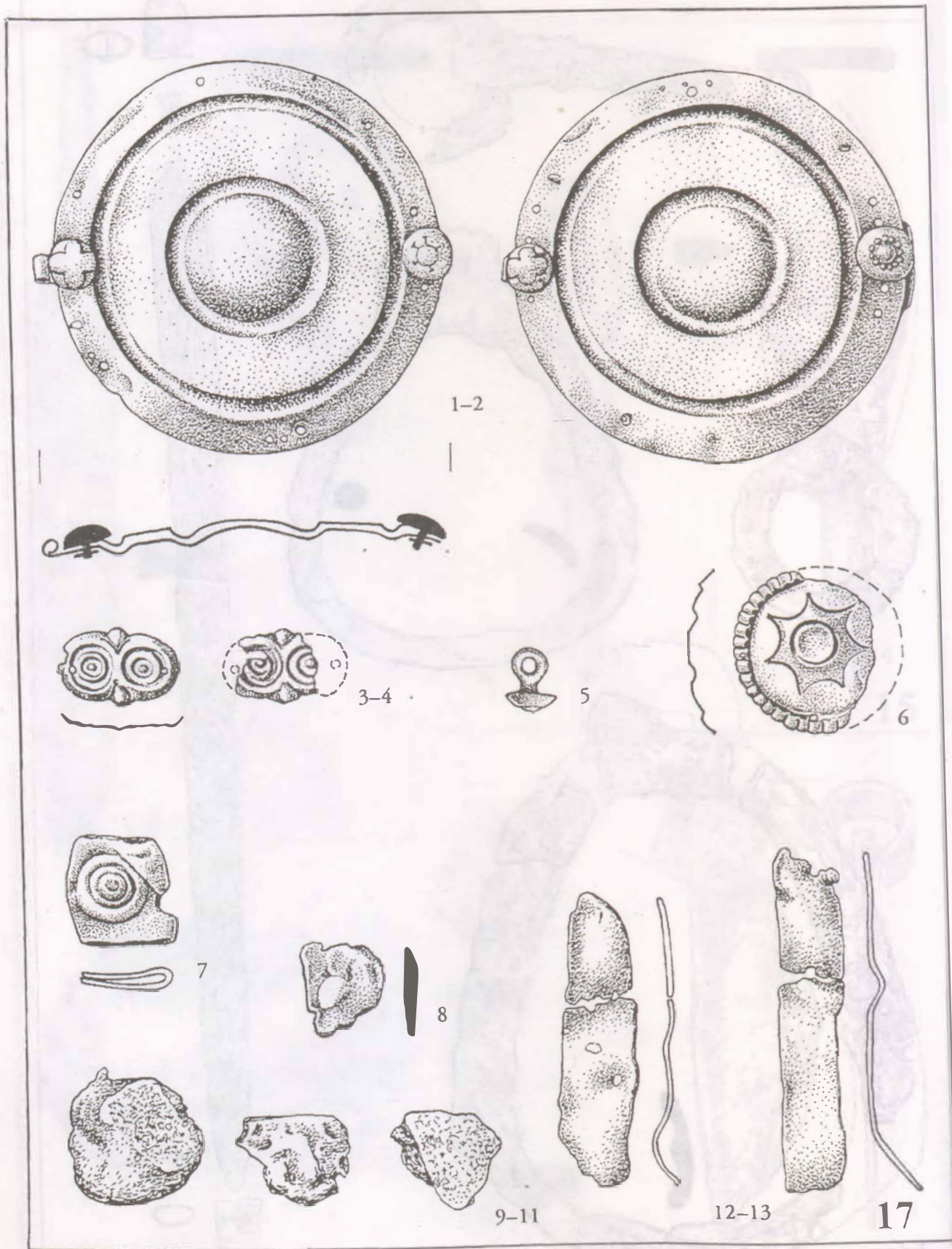

132. tábla: Püspökladány-Eperjesvölgy. 17. sír (1:1)

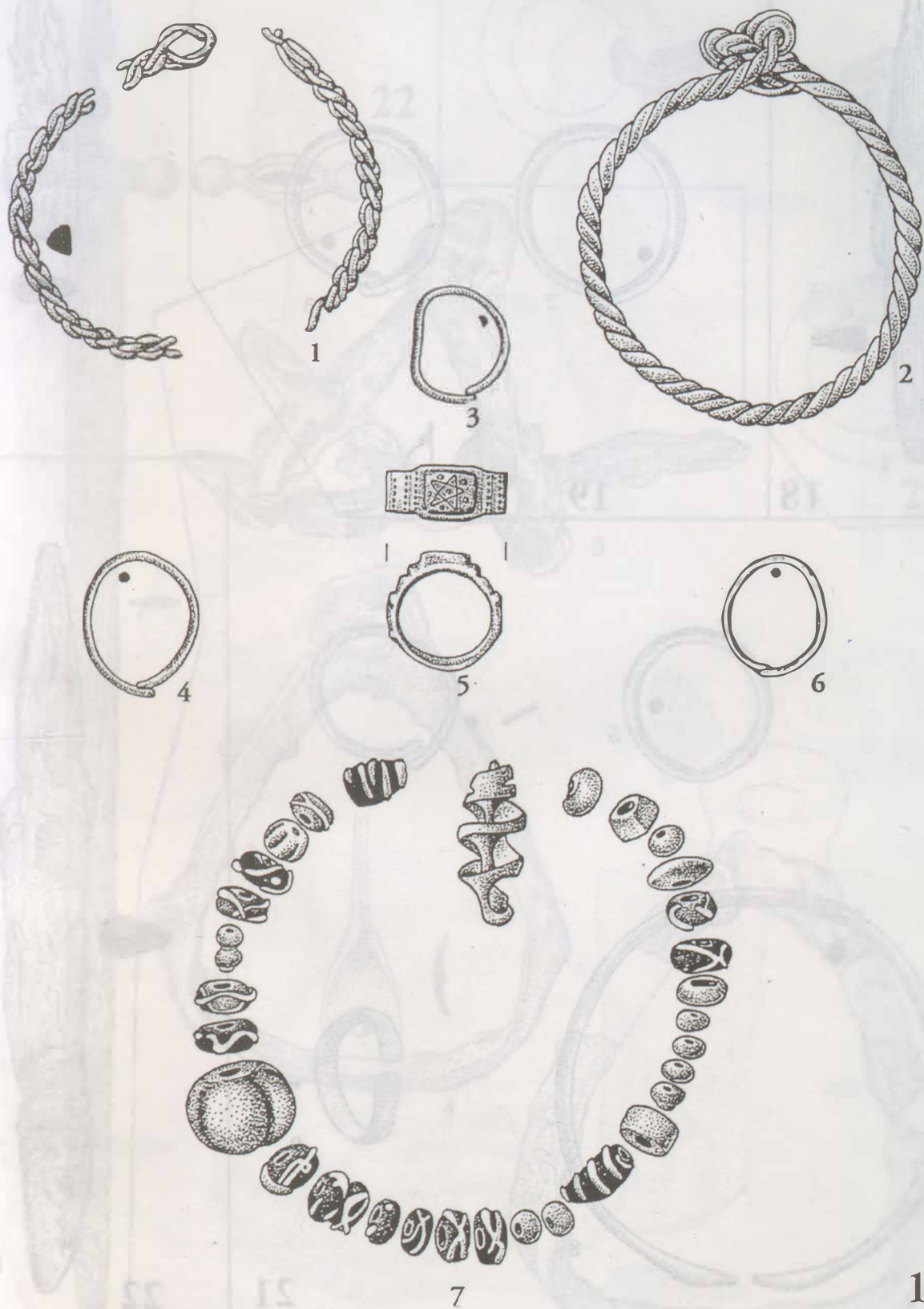

133. tábla: Püspökladány-Eperjesvölgy. 17. sír (1:1)

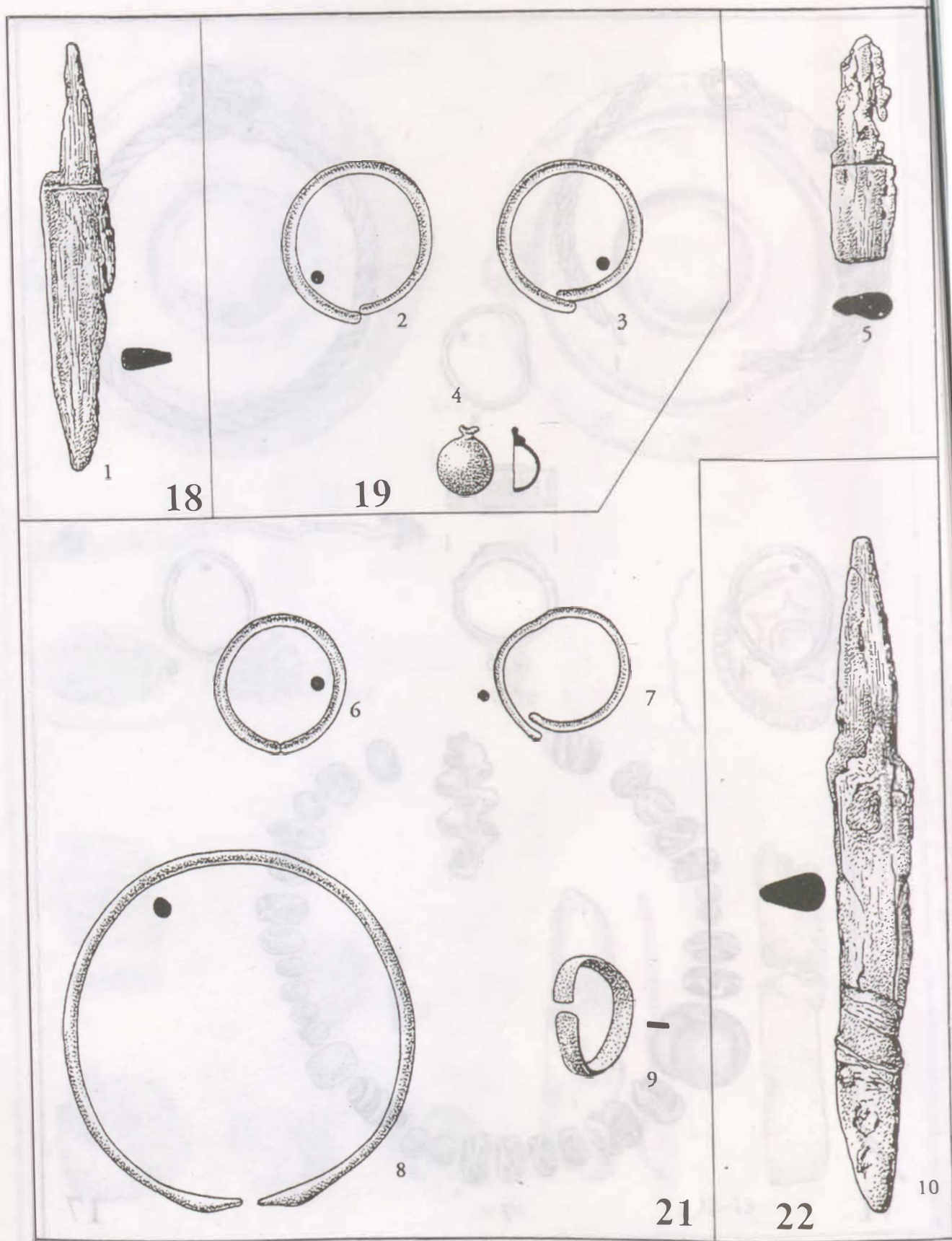

134. tábla: Püspökladány-Eperjesvölgy. 18–19., 21–22. sír (1:1)

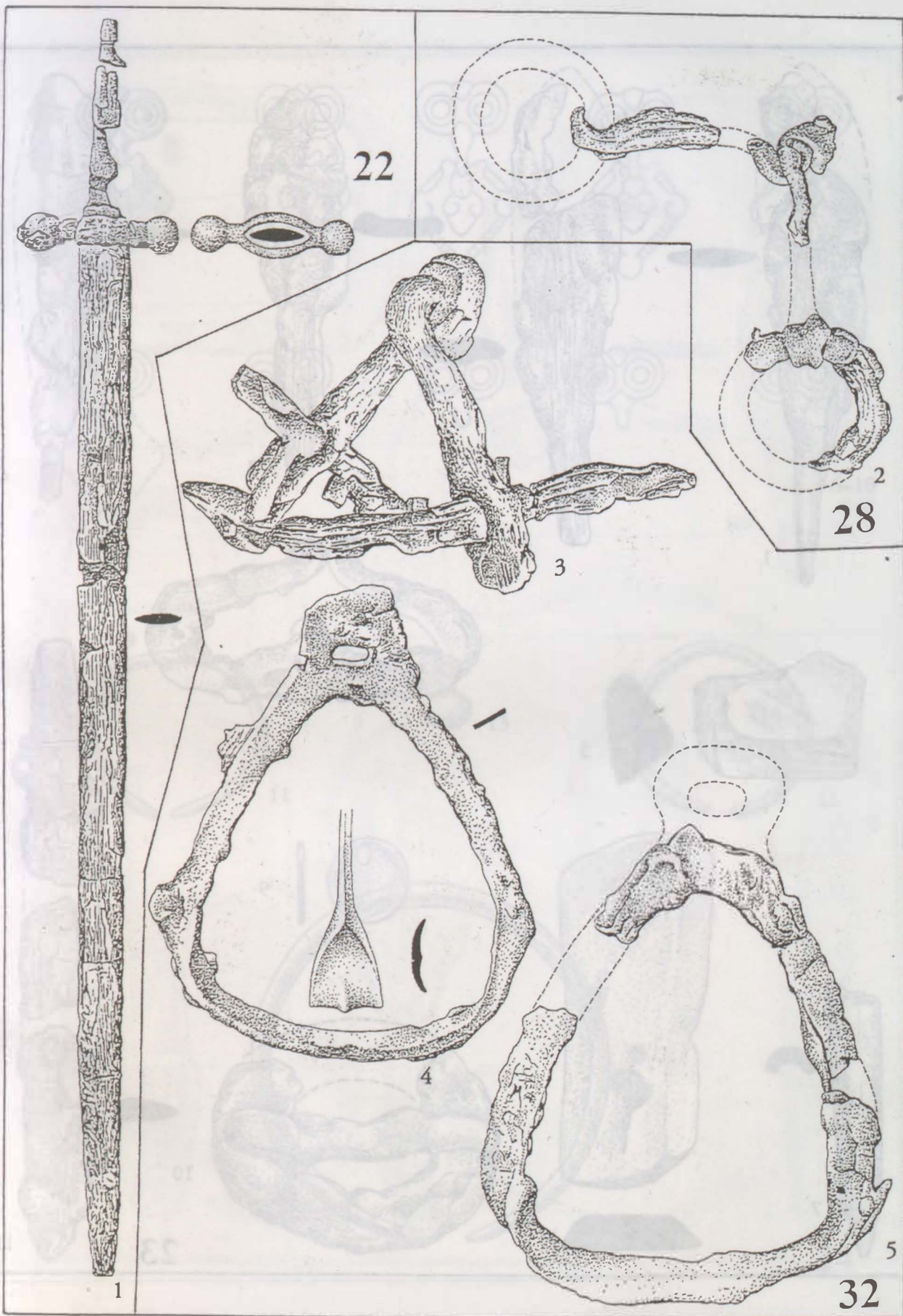

135. tábla: Püspökladány-Eperjesvölgy. 22. sír (1:4), 28., 32. sír (1:2)

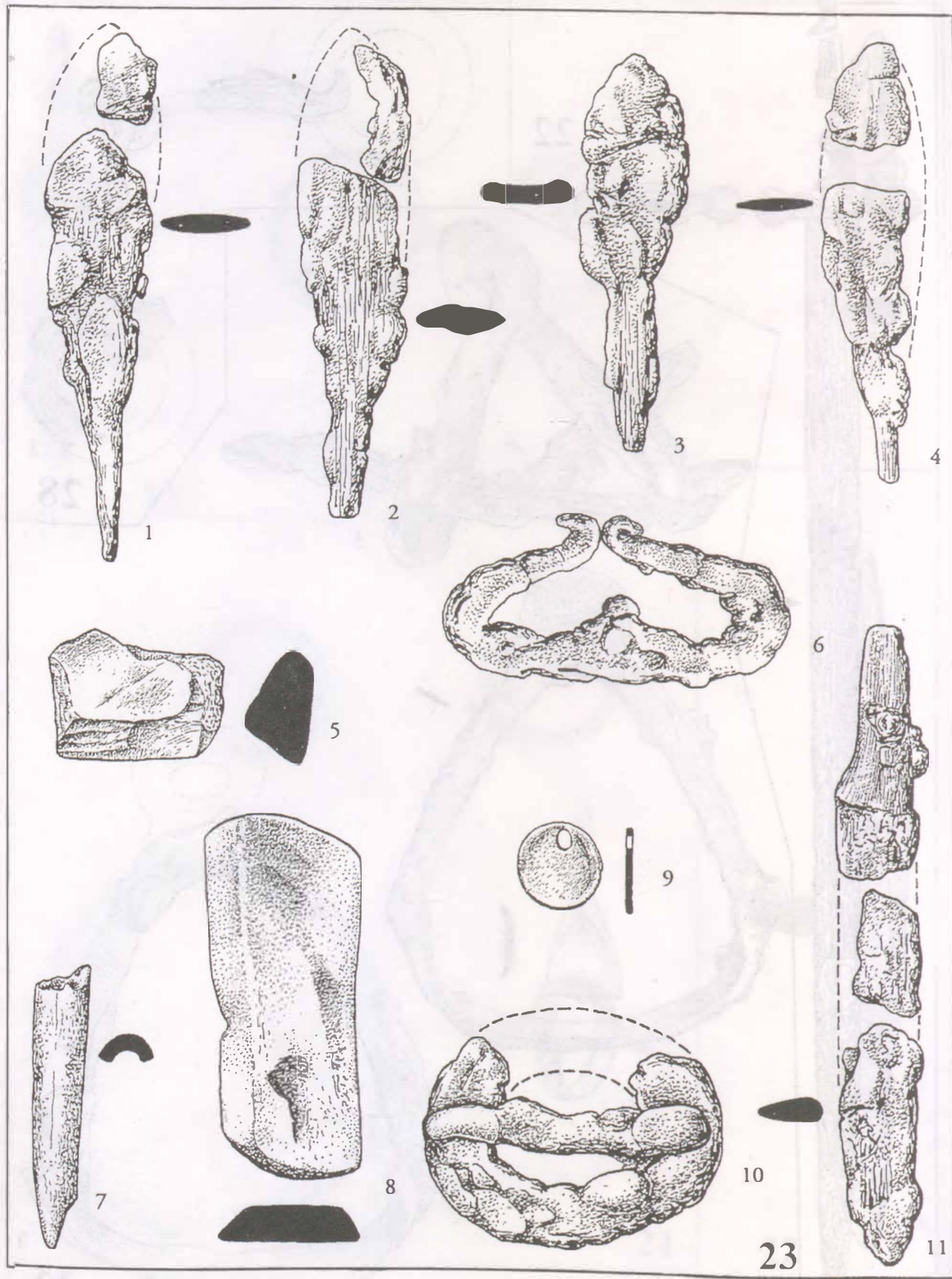

136. tábla: Püspökladány-Eperjesvölgy. 23. sír (1:1)

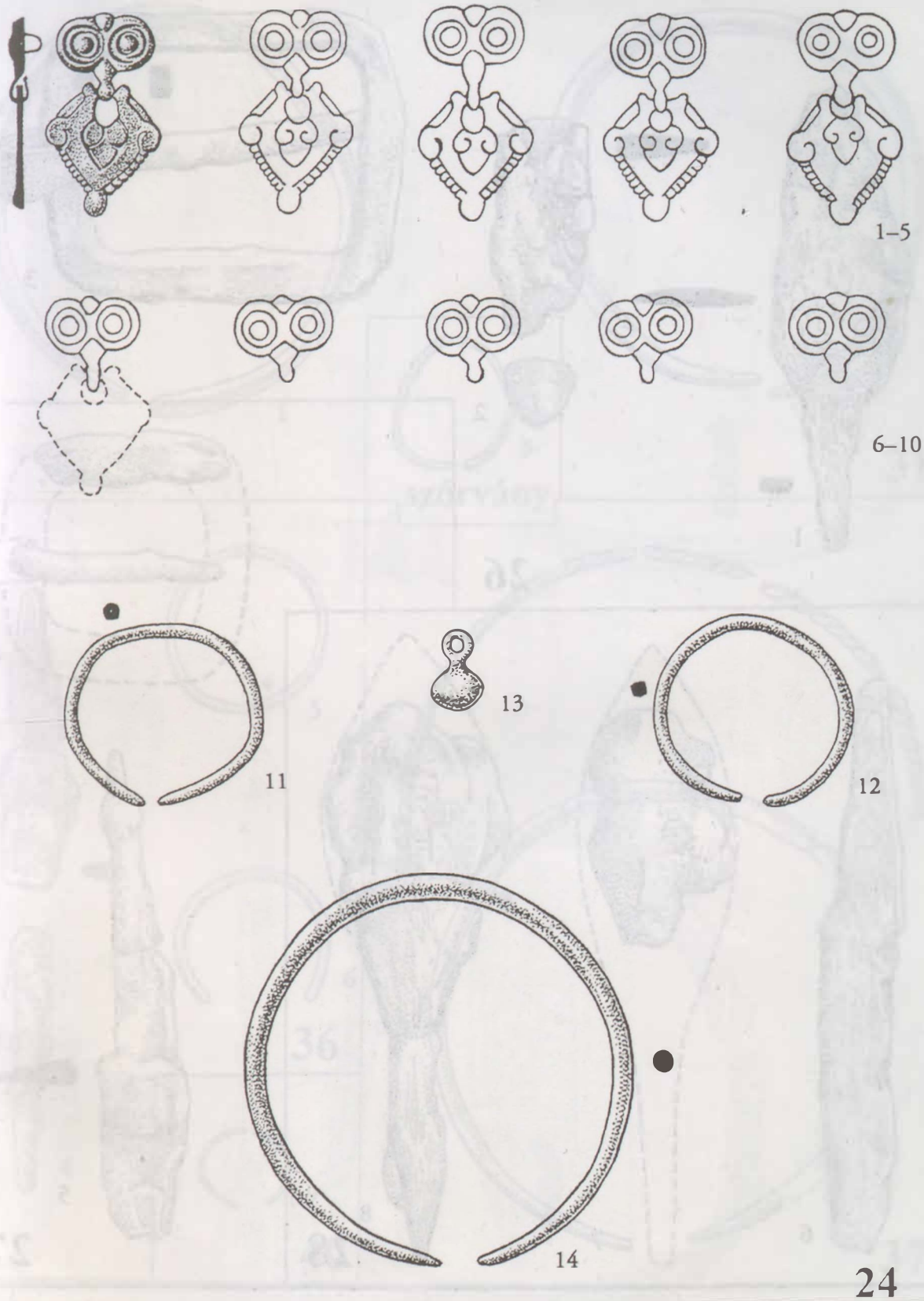

137. tábla: Püspökladány-Eperjesvölgy. 24. sír (1:1)

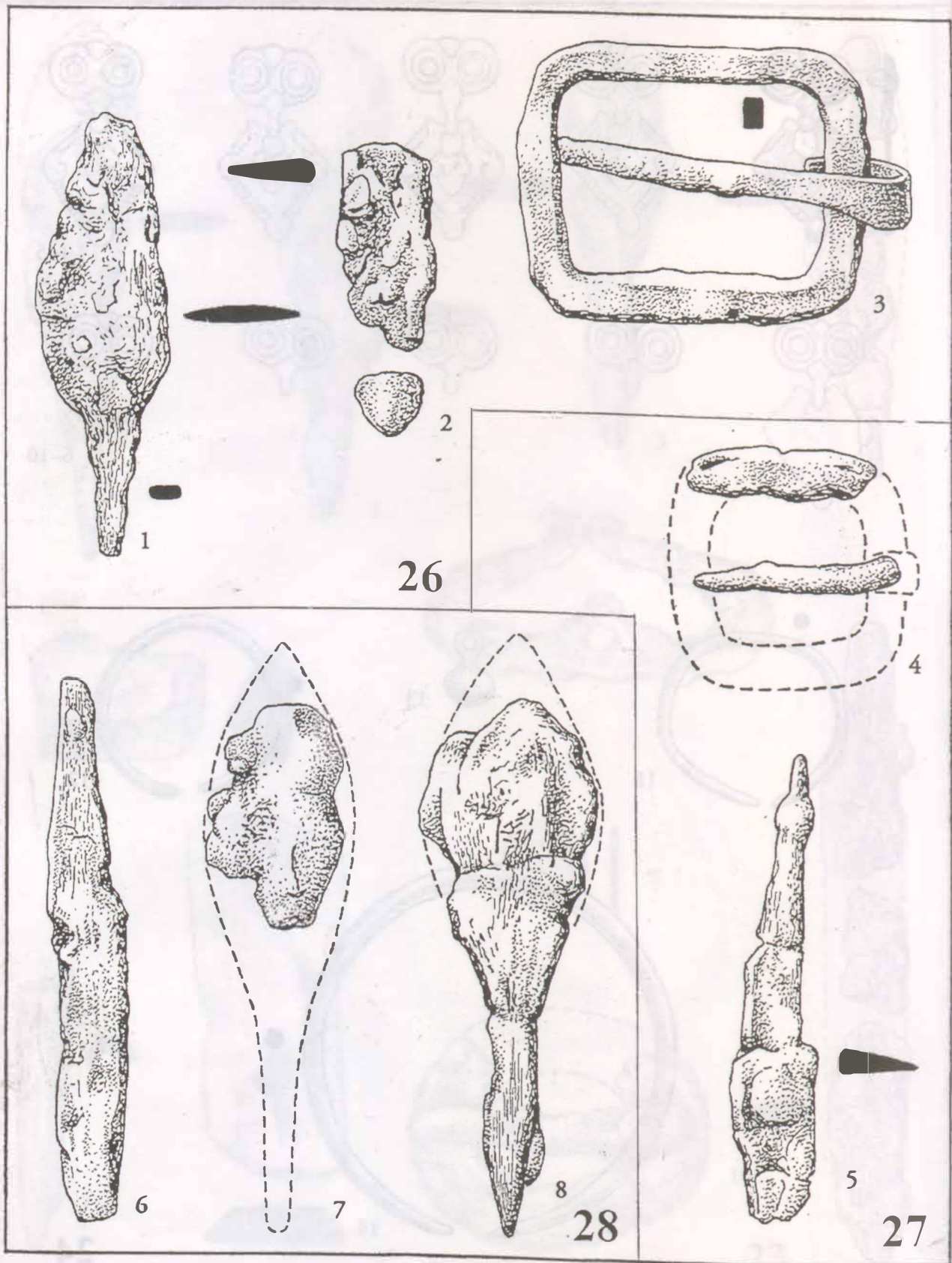

138. tábla: Püspökladány-Eperjesvölgy. 26–28. sír (1:1)

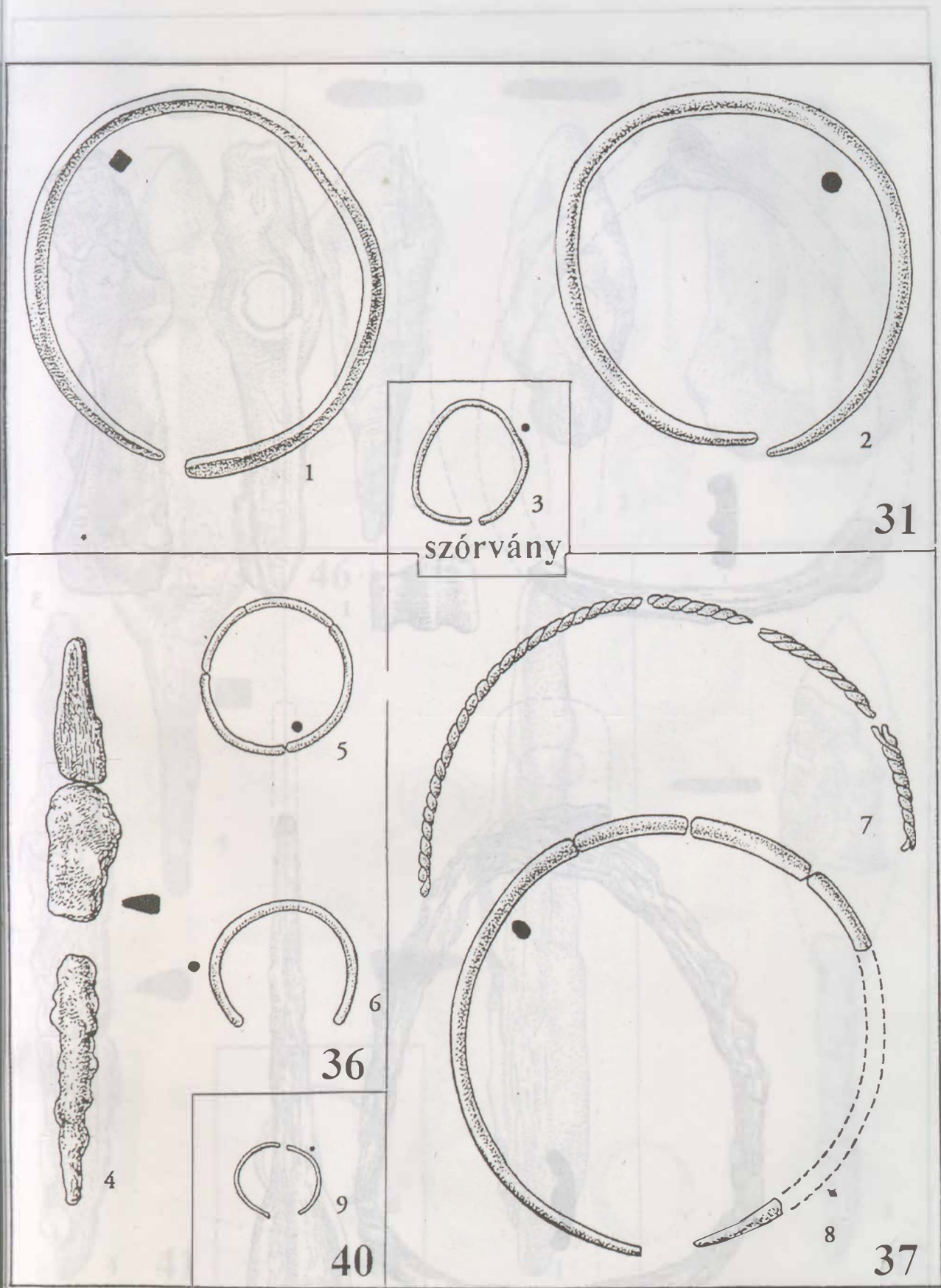

139. tábla: Püspökladány-Eperjesvölgy. 31., 36–37., 40. sír és szórvány (1:1)

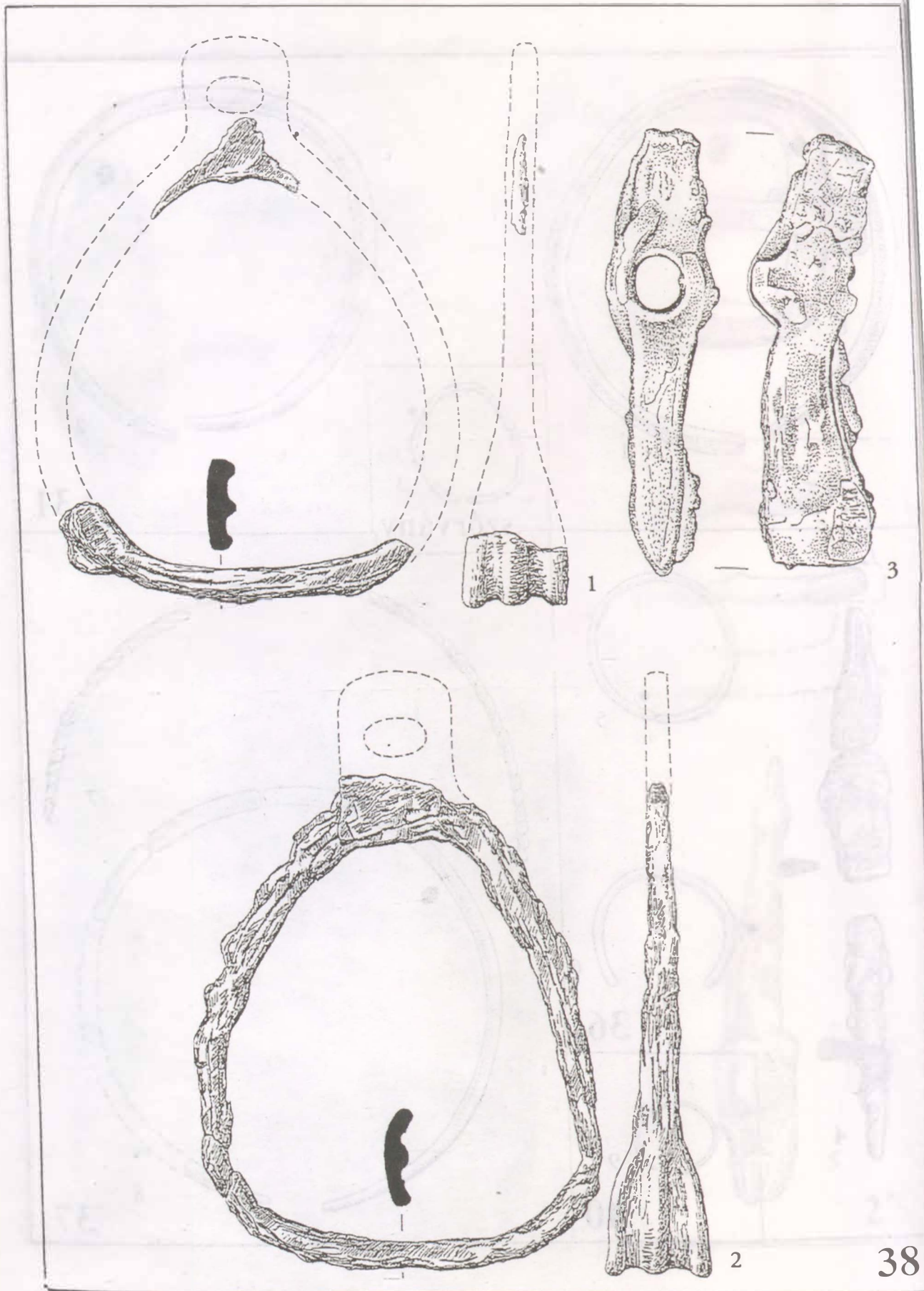

140. tábla: Püspökladány-Eperjesvölgy. 38. sír (1:2)

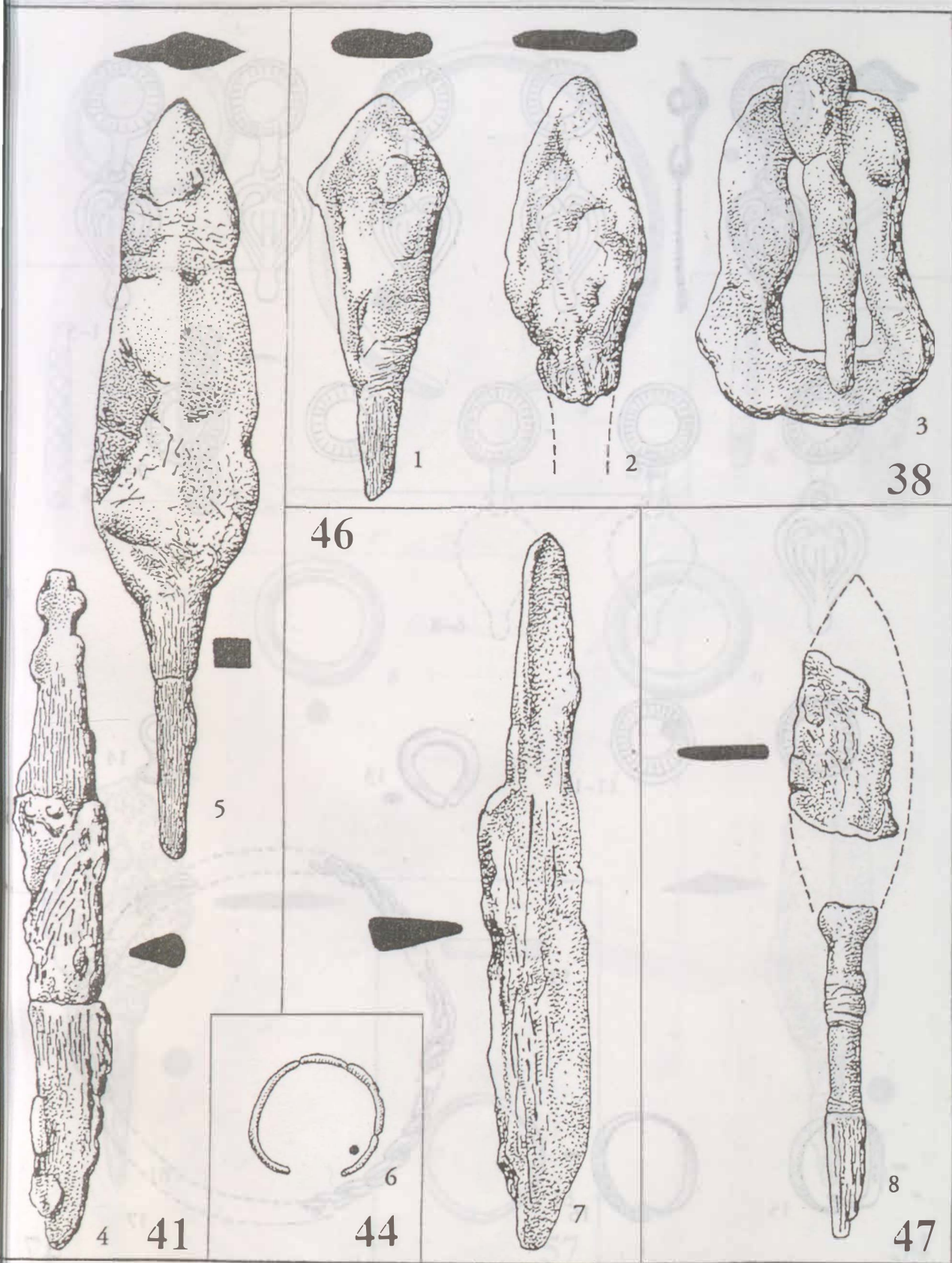

41. tábla: Püspökladány-Eperjesvölgy. 38., 41., 44., 46–47. sír (1:1)

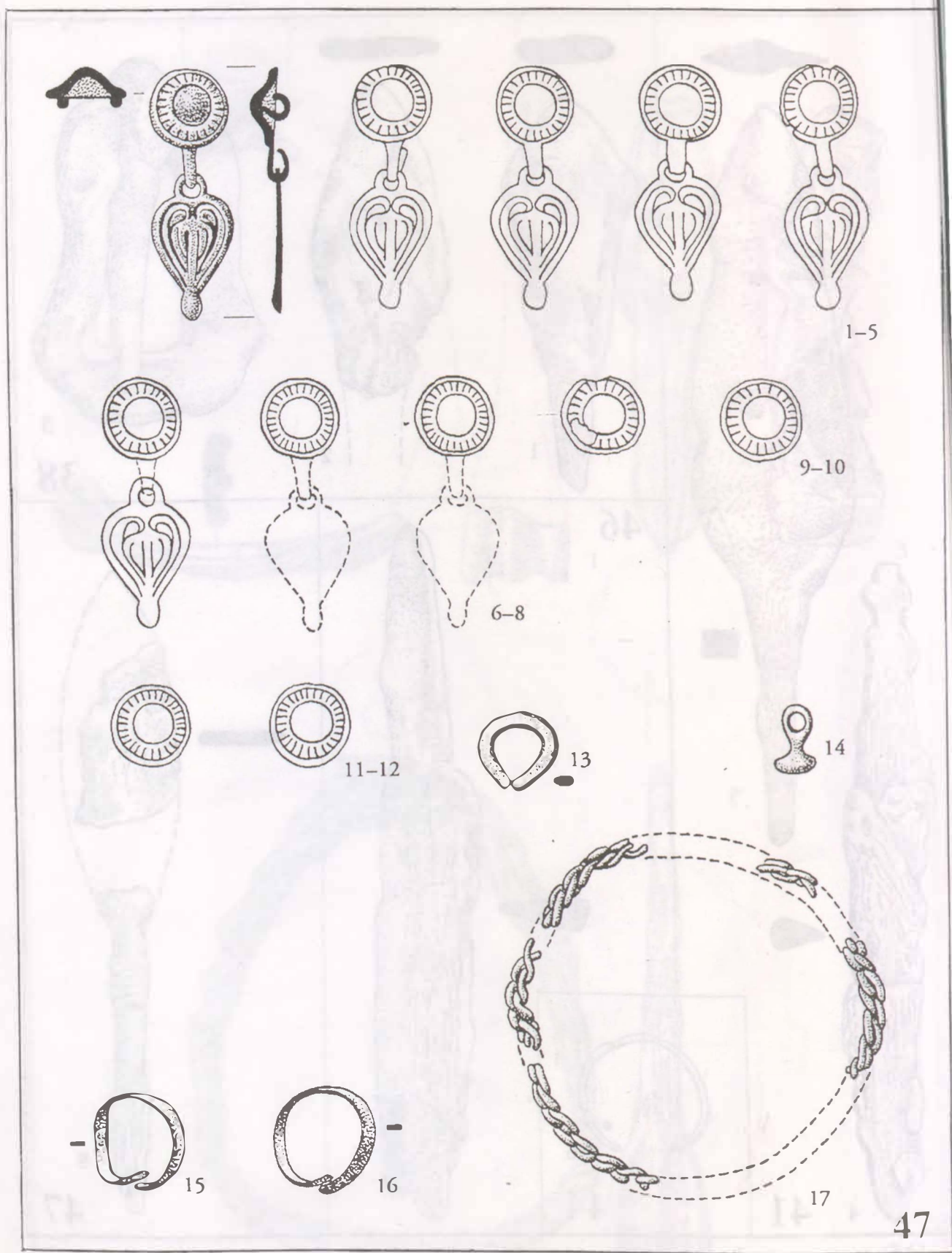

142. tábla: Püspökladány-Eperjesvölgy. 47. sír (1:1)

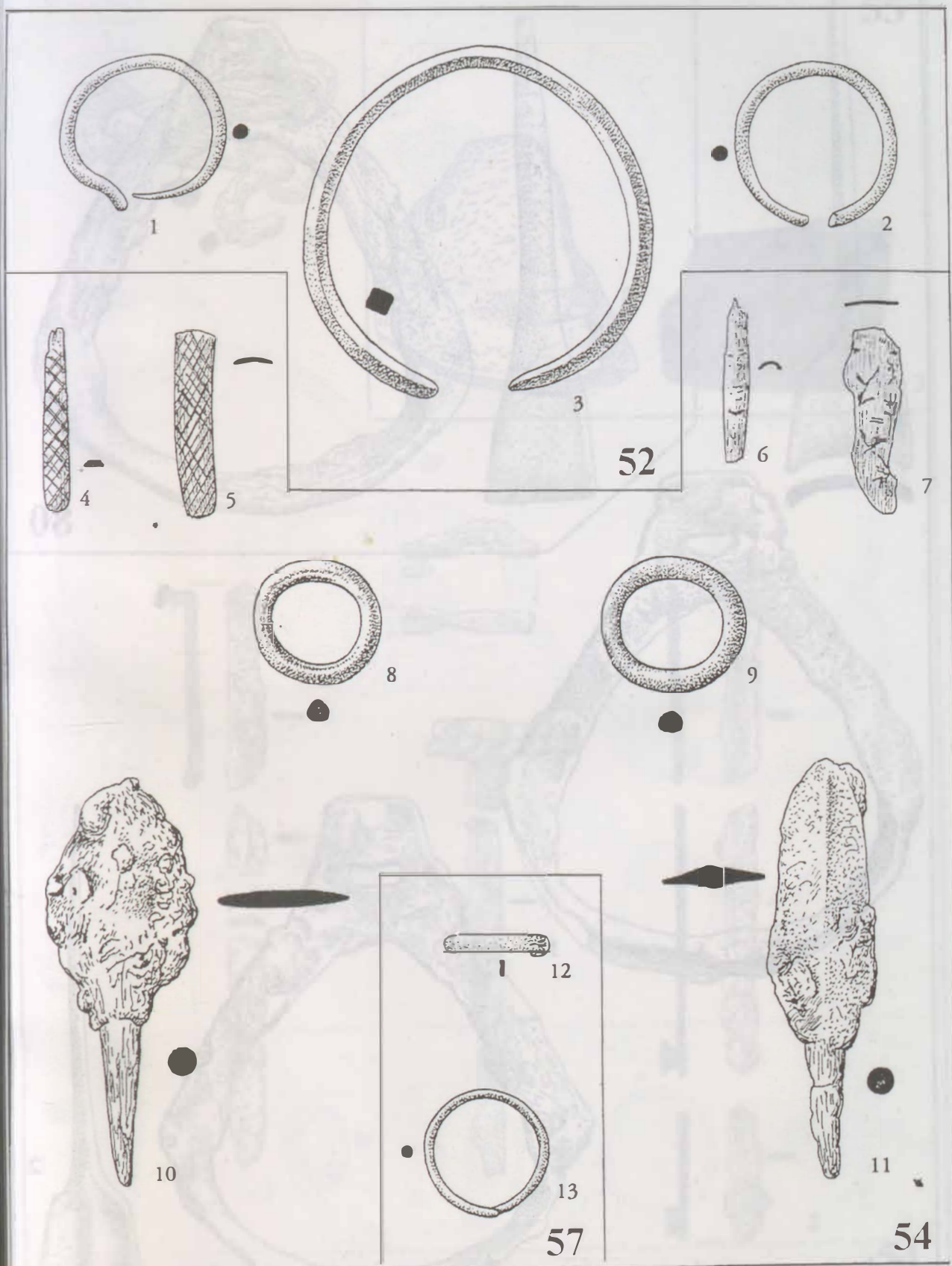

143. tábla: Püspökladány-Eperjesvölgy. 52., 54., 57. sír (1:1)

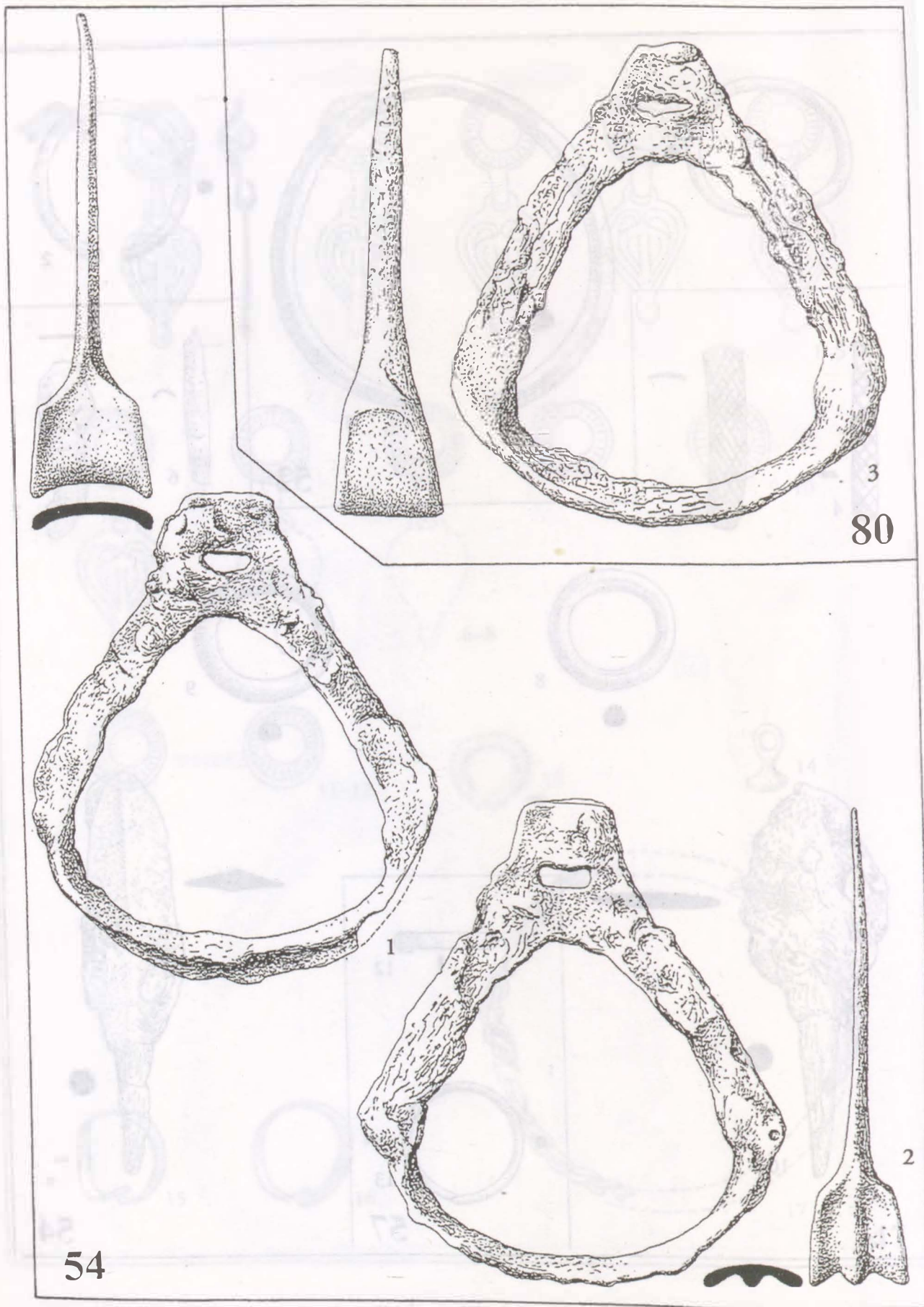

144. tábla: Püspökladány-Eperjesvölgy. 54., 80. sír (1:2)

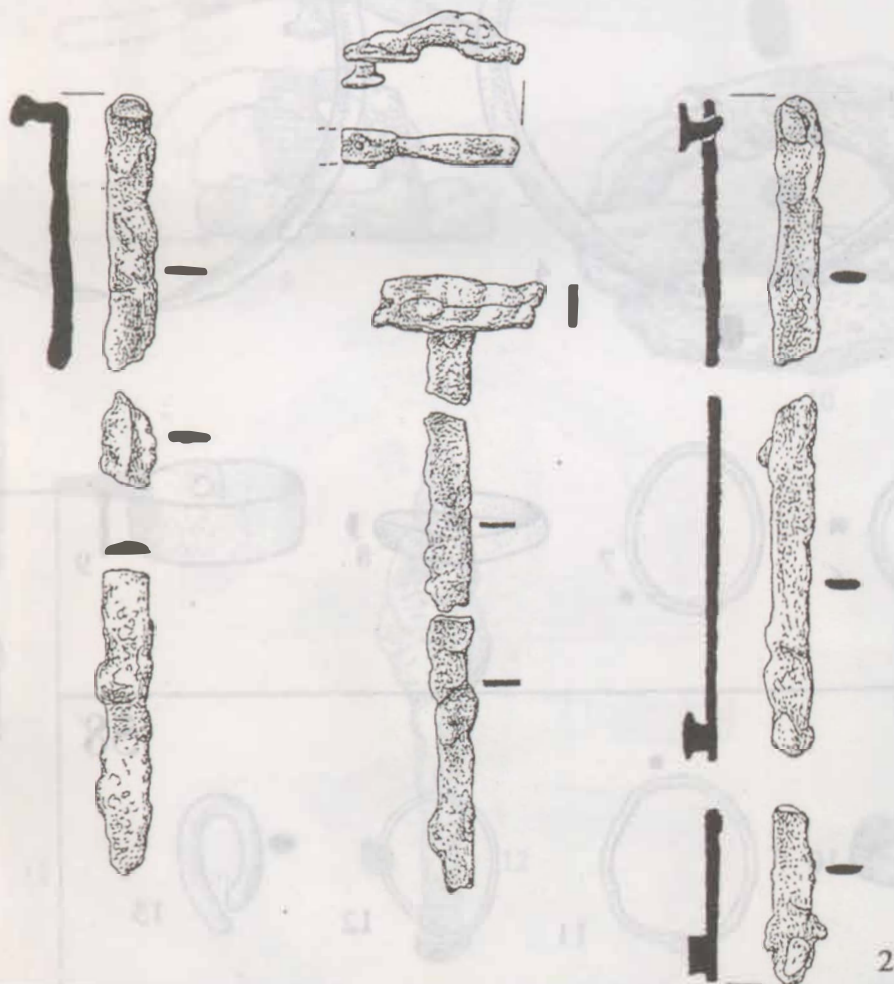
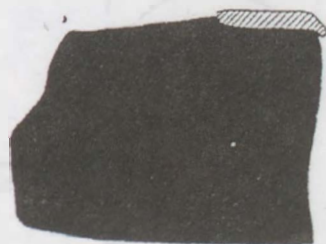

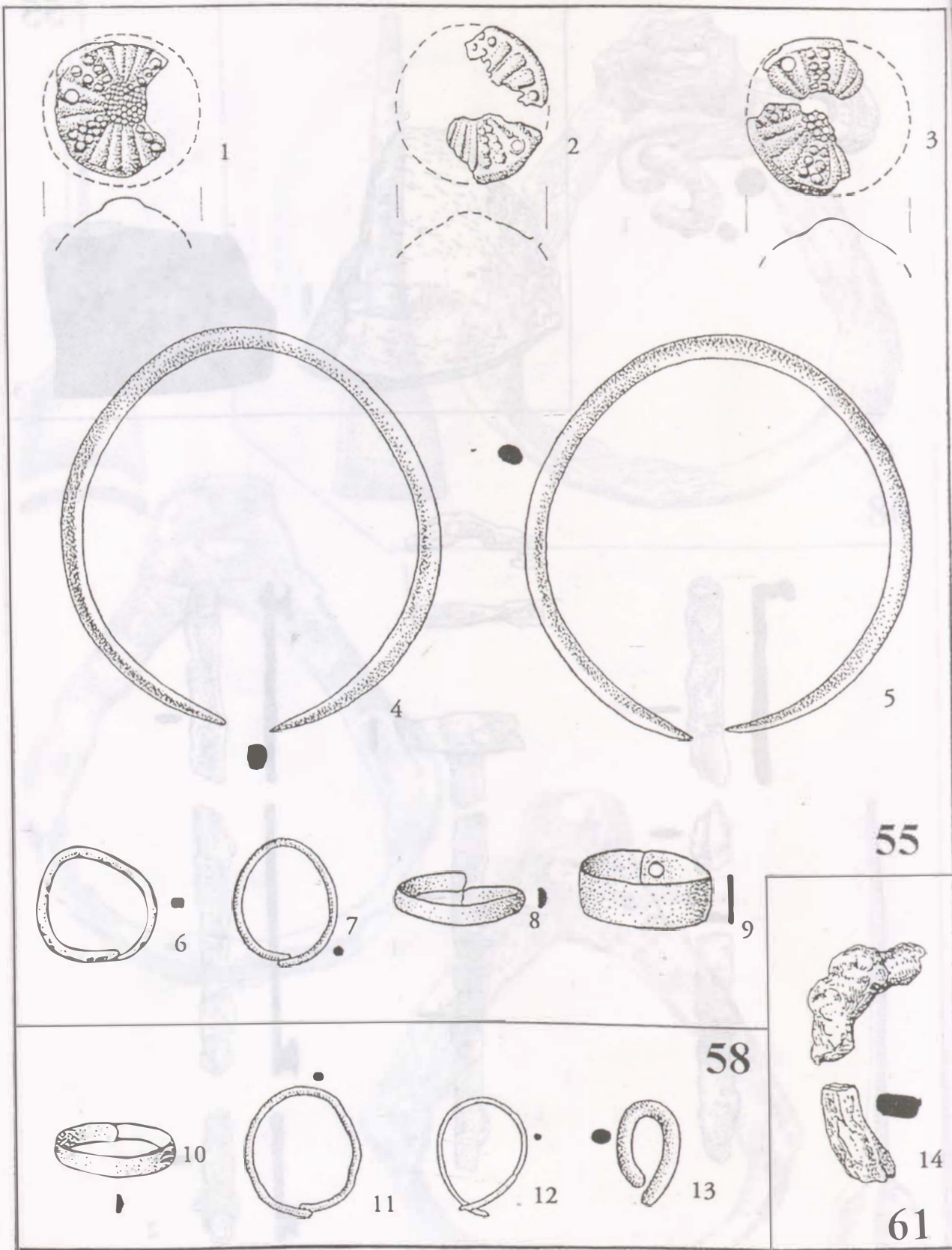

146. tábla: Püspökladány-Eperjesvölgy. 55., 58., 61. sír (1:1)

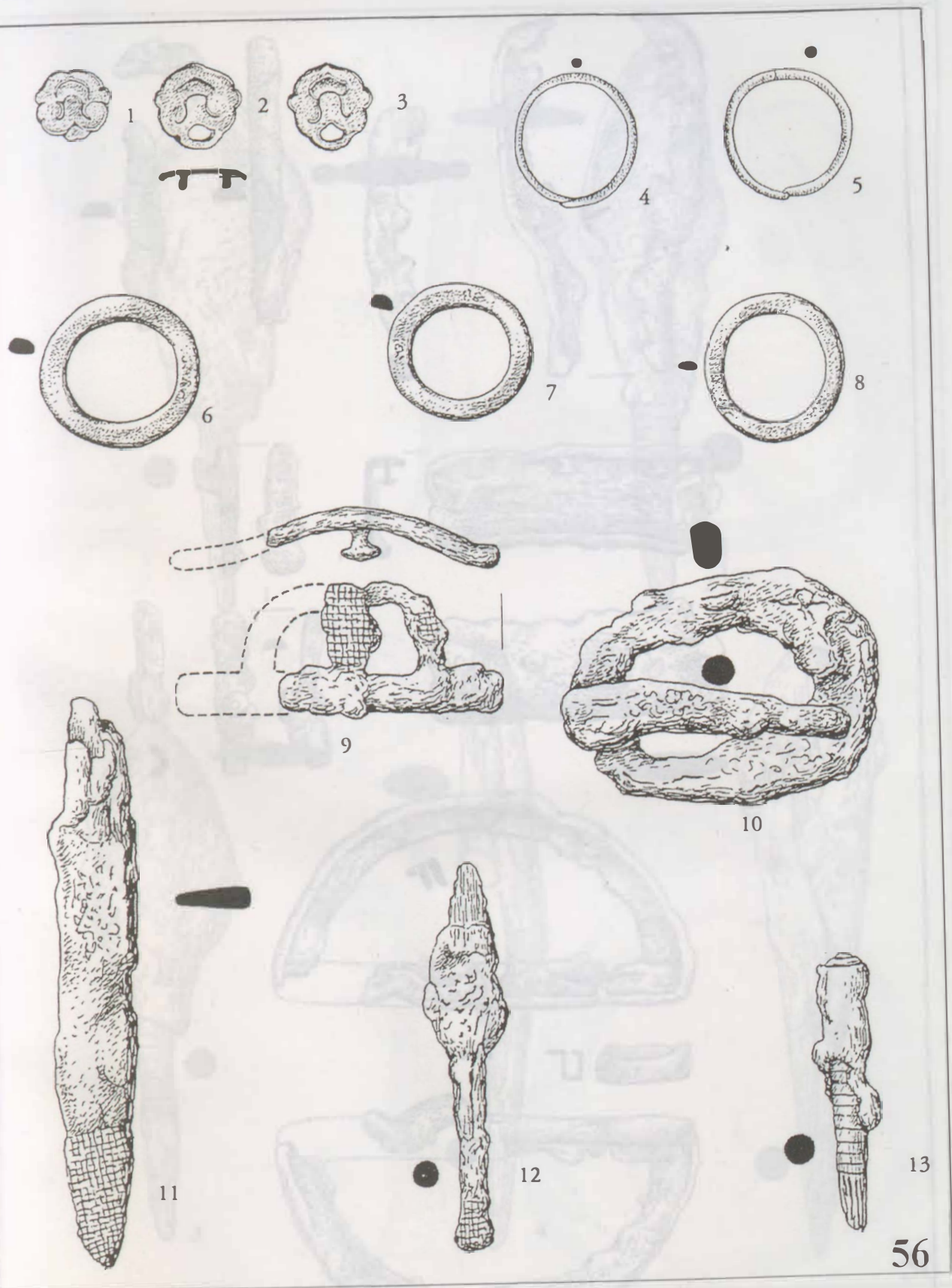

147. tábla: Püspökladány-Eperjesvölgy. 56. sír (1:1)

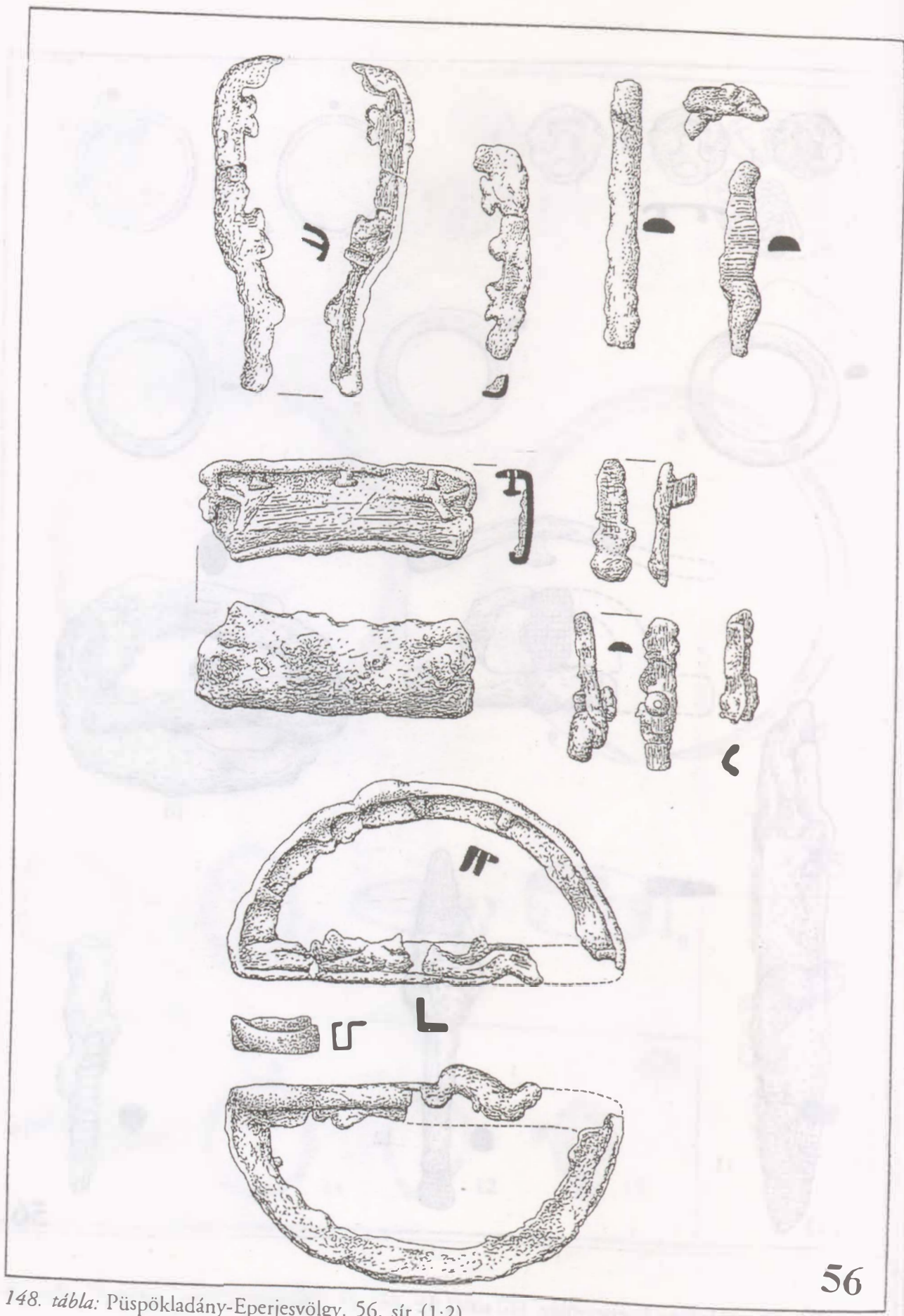

148. tábla: Püspökladány-Eperjesvölgy. 56. sír (1:2)

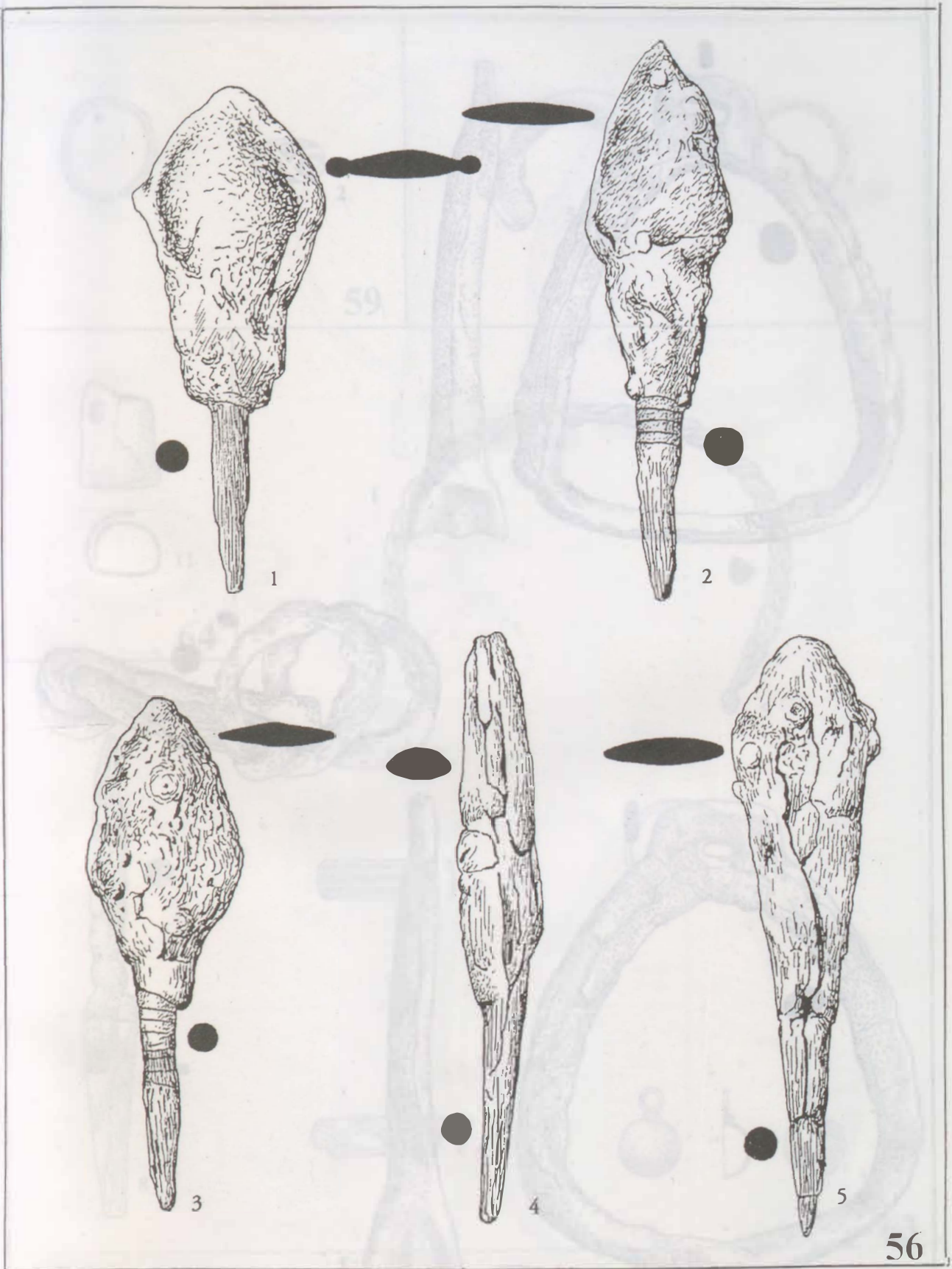

149. tábla: Püspökladány-Eperjesvölgy. 56. sír (1:1)

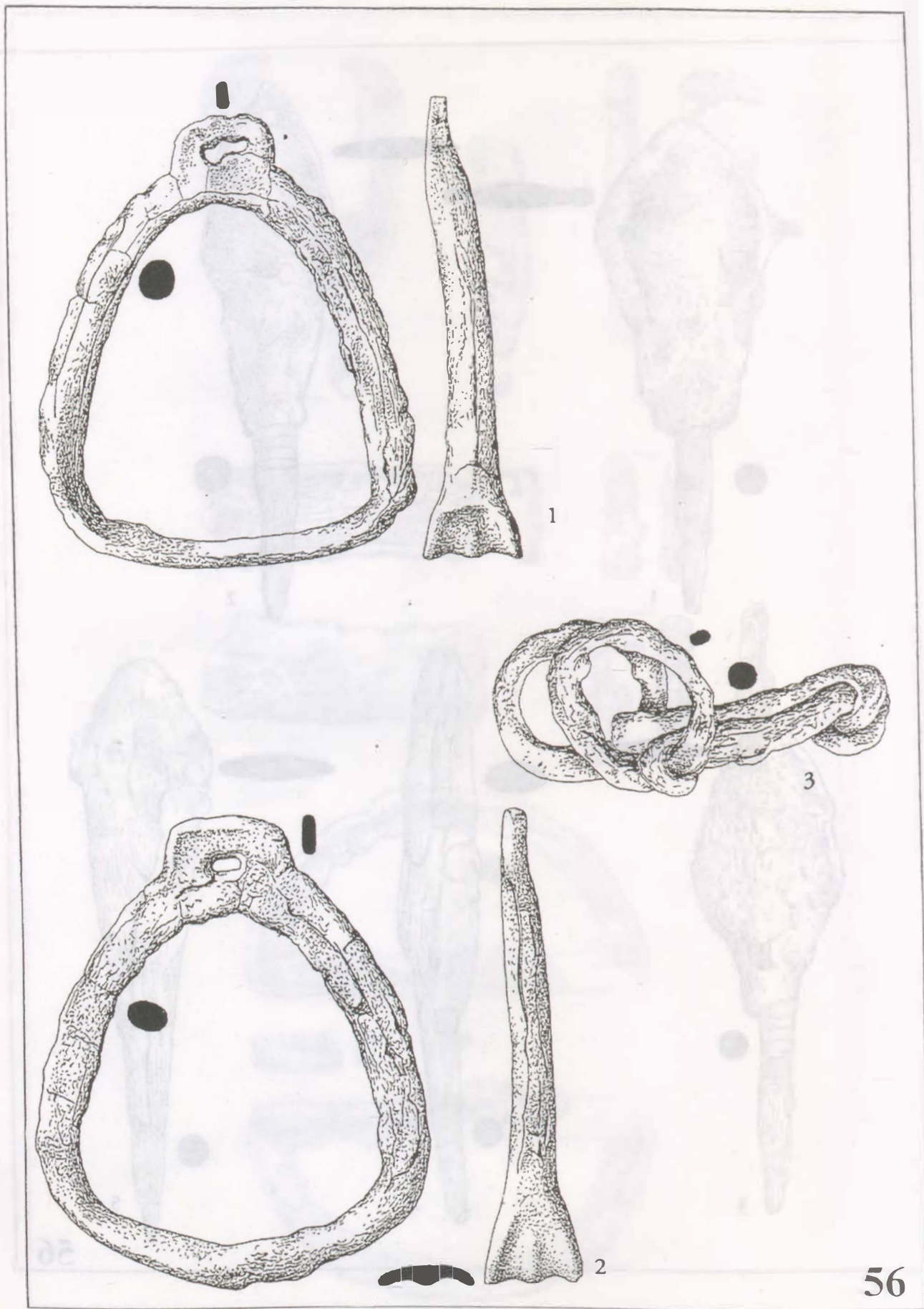

150. tábla: Püspökladány-Eperjesvölgy. 56. sír (1:2)



1



2



3



4

59

61



11

64

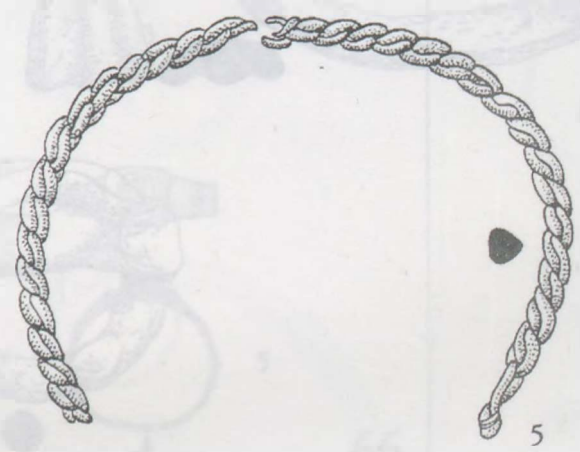

5



8



6

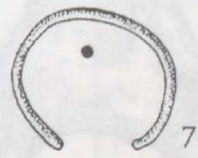

7



9



10

63

151. tábla: Püspökladány-Eperjesvölgy. 59., 61., 63–64. sír (1:1)

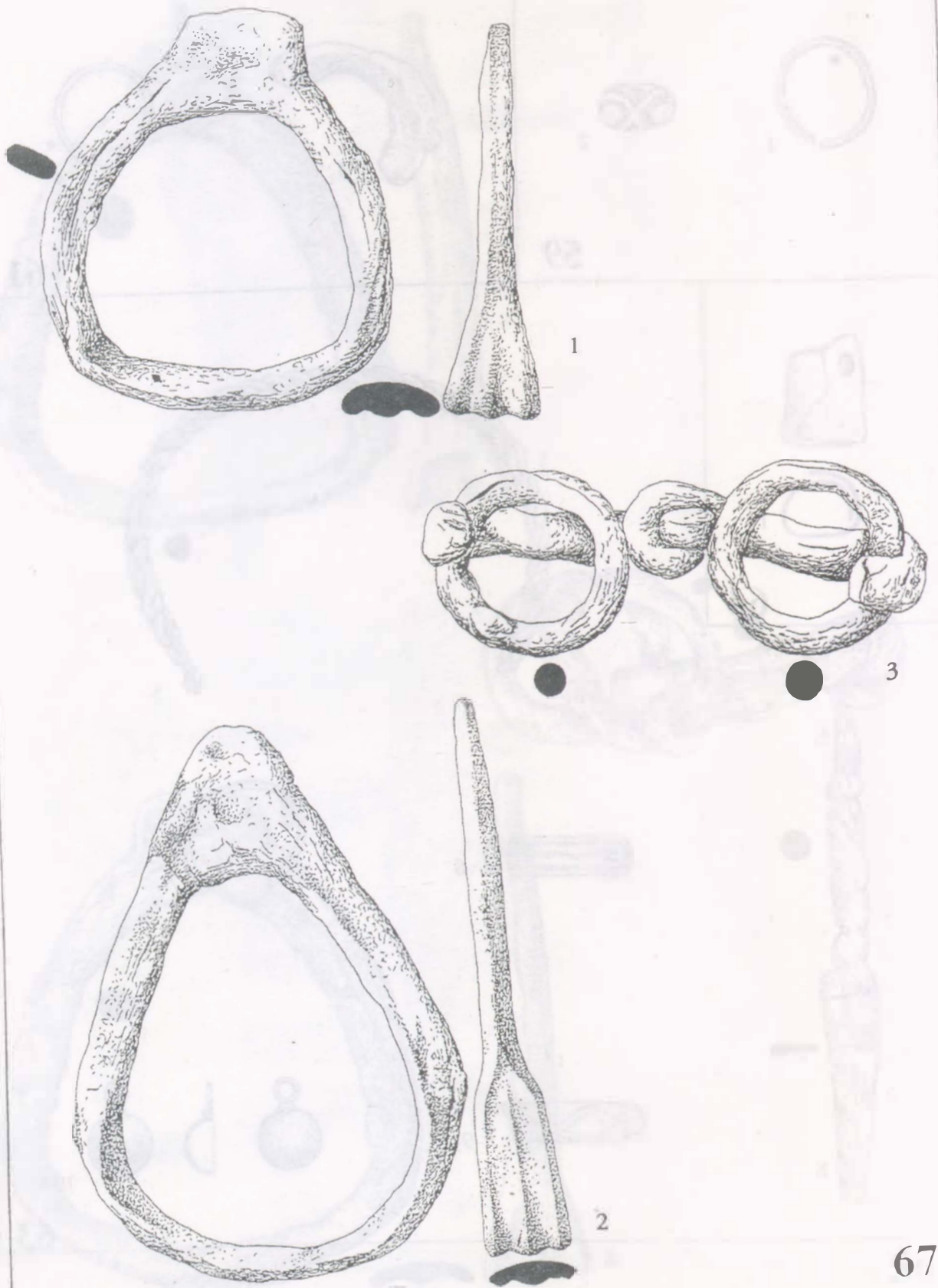

152. tábla: Püspökladány-Eperjesvölgy. 67. sír (1:2)

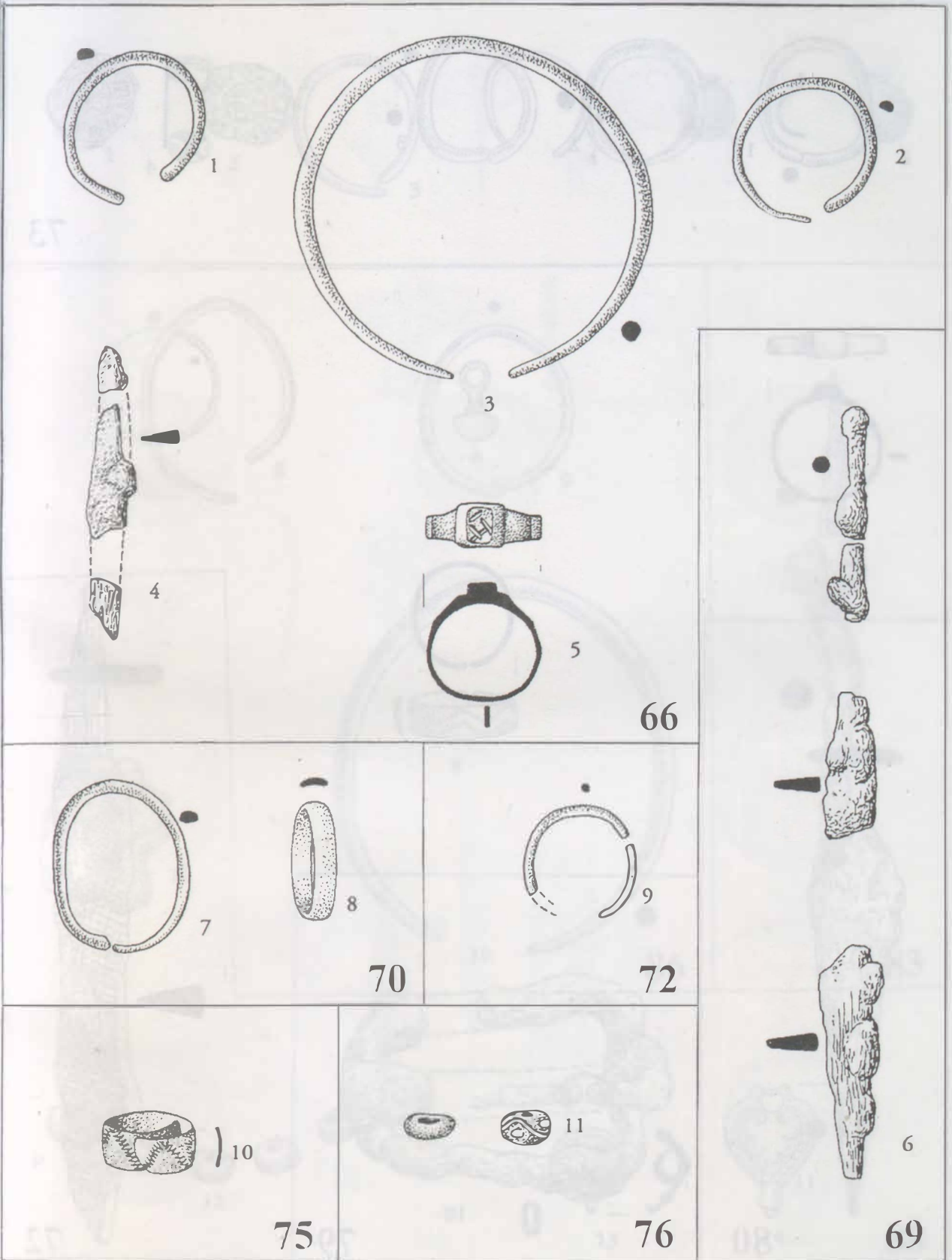

153. tábla: Püspökladány-Eperjesvölgy. 66., 69., 70., 72., 75–76. sír (1:1)

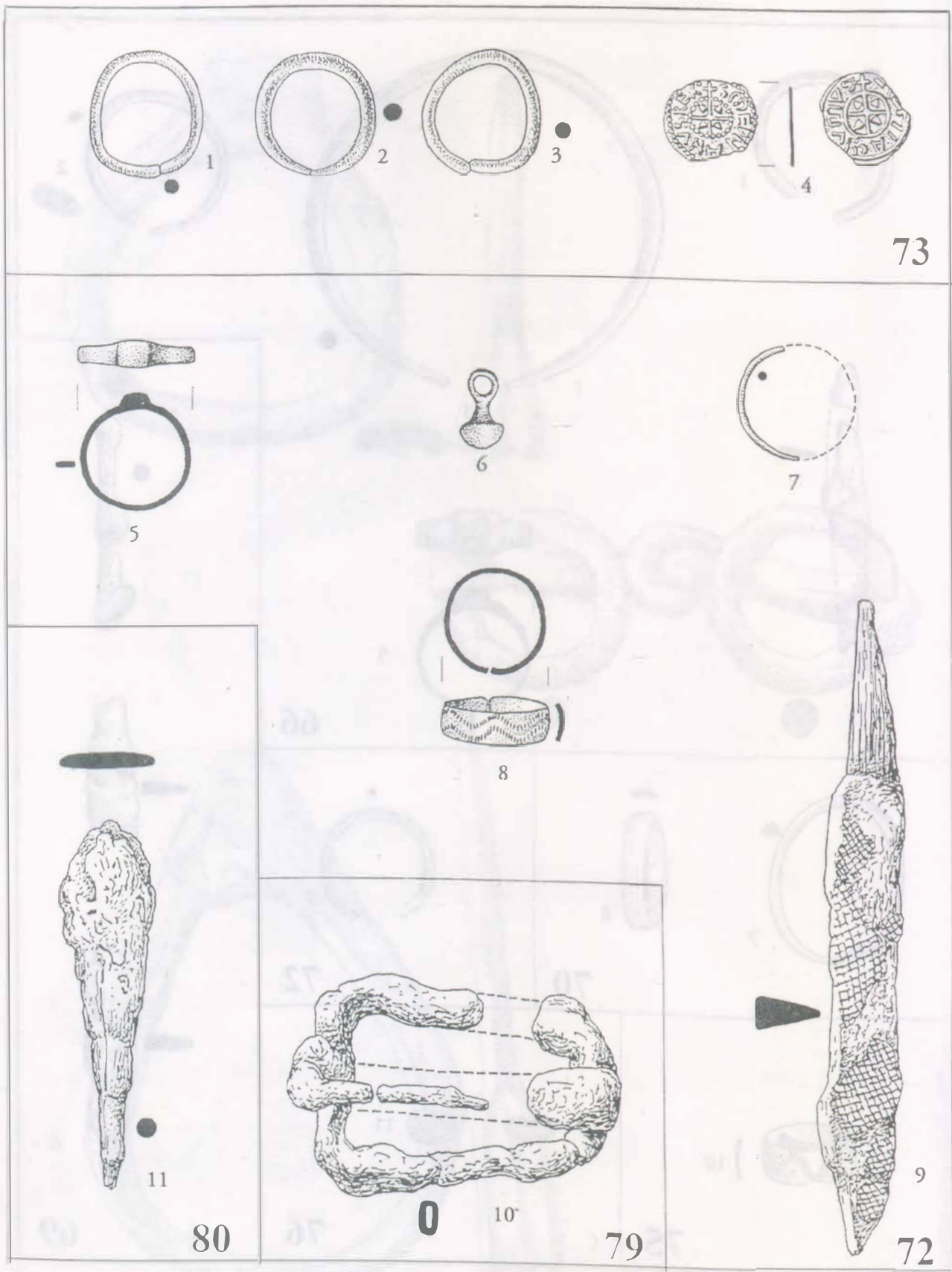

154. tábla: Püspökladány-Eperjesvölgy. 72-73., 79-80. sír (1:1)

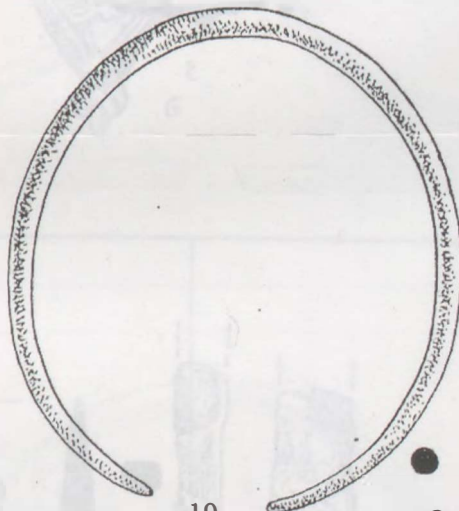
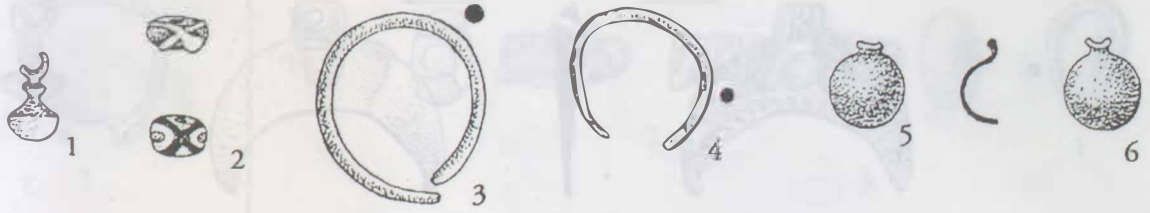

86

83



12



13

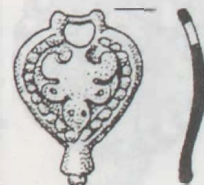

14

88

155. tábla: Püspökladány-Eperjesvölgy. 83., 86., 88. sír (1:1)

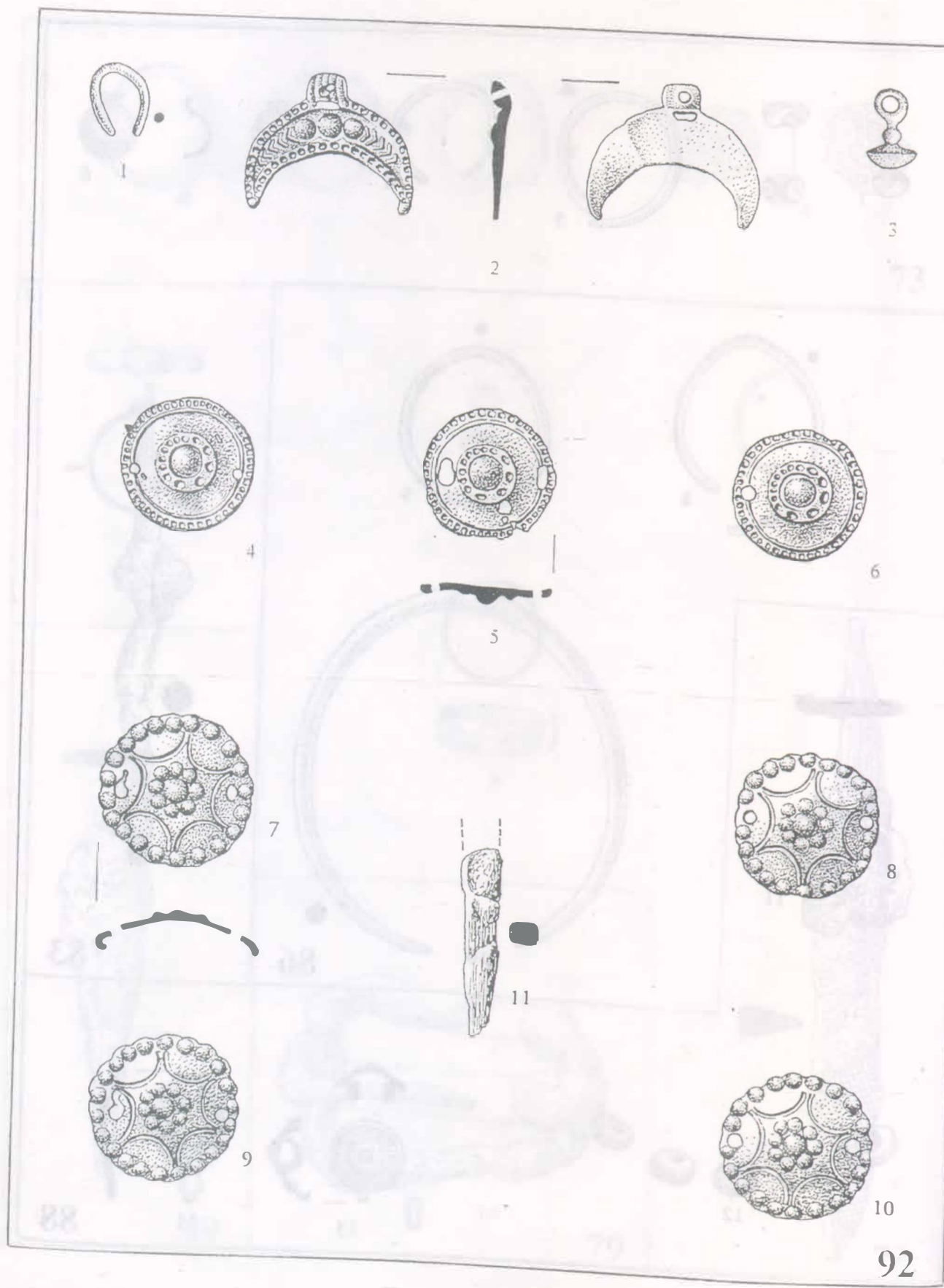

156. tábla: Püspökladány-Eperjesvölgy. 92. sír (1:1)



1



3



2

93



4



5



6



7

95



8



90



9

97



10

99

57. tábla: Püspökladány-Eperjesvölgy. 90., 93., 95., 97., 99. sír (1:1)

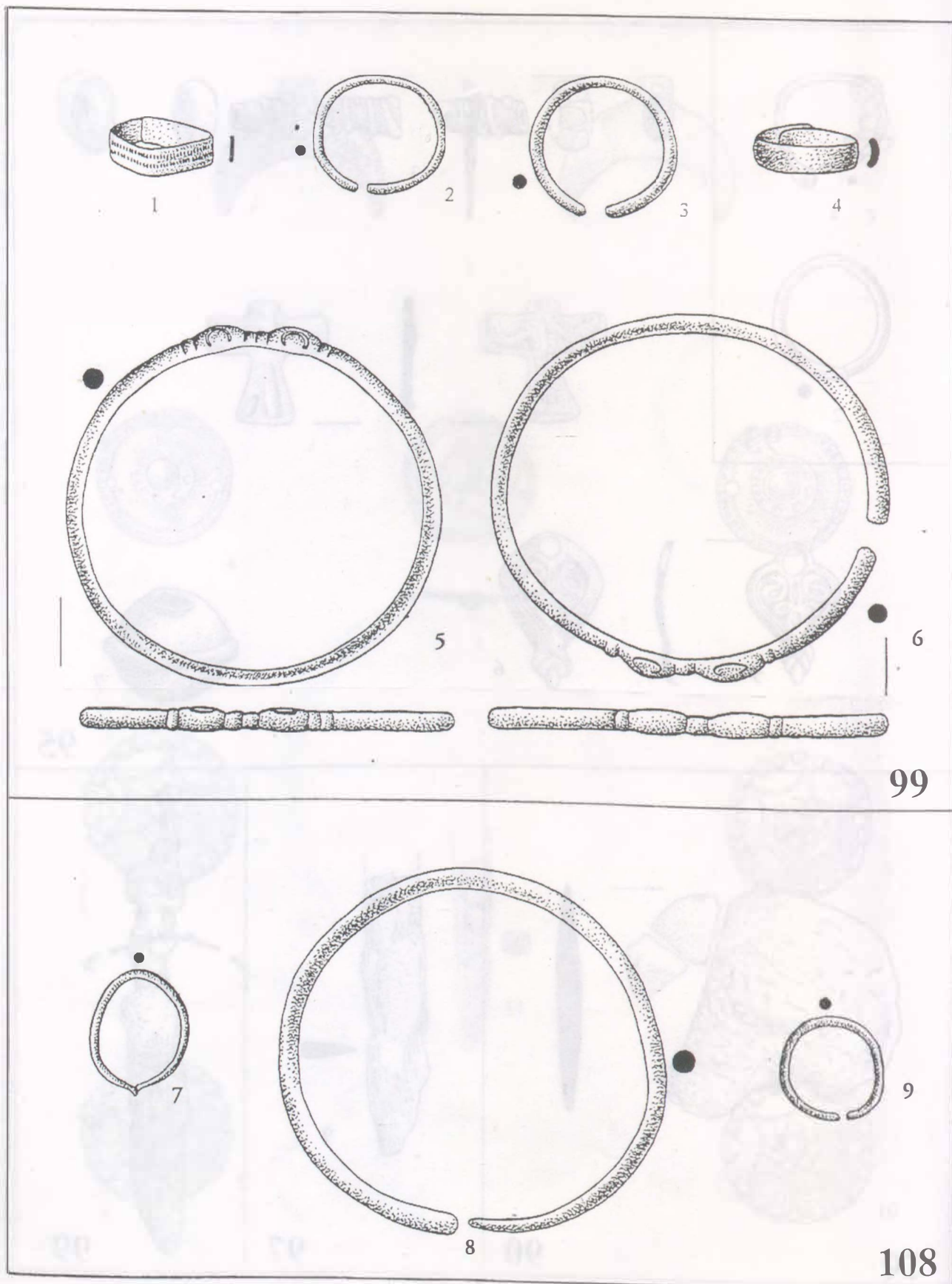

158. tábla: Püspökládány-Eperjesvölgy. 99., 108. sír (1:1)



100



2



3



4



101

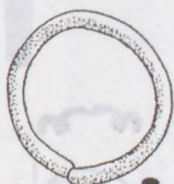

5



6



7



8



9



10



11

103



12



13



14



15



16



17



18



19

104

159. tábla: Püspökladány-Eperjesvölgy. 100–101., 103–104. sír (1:1)

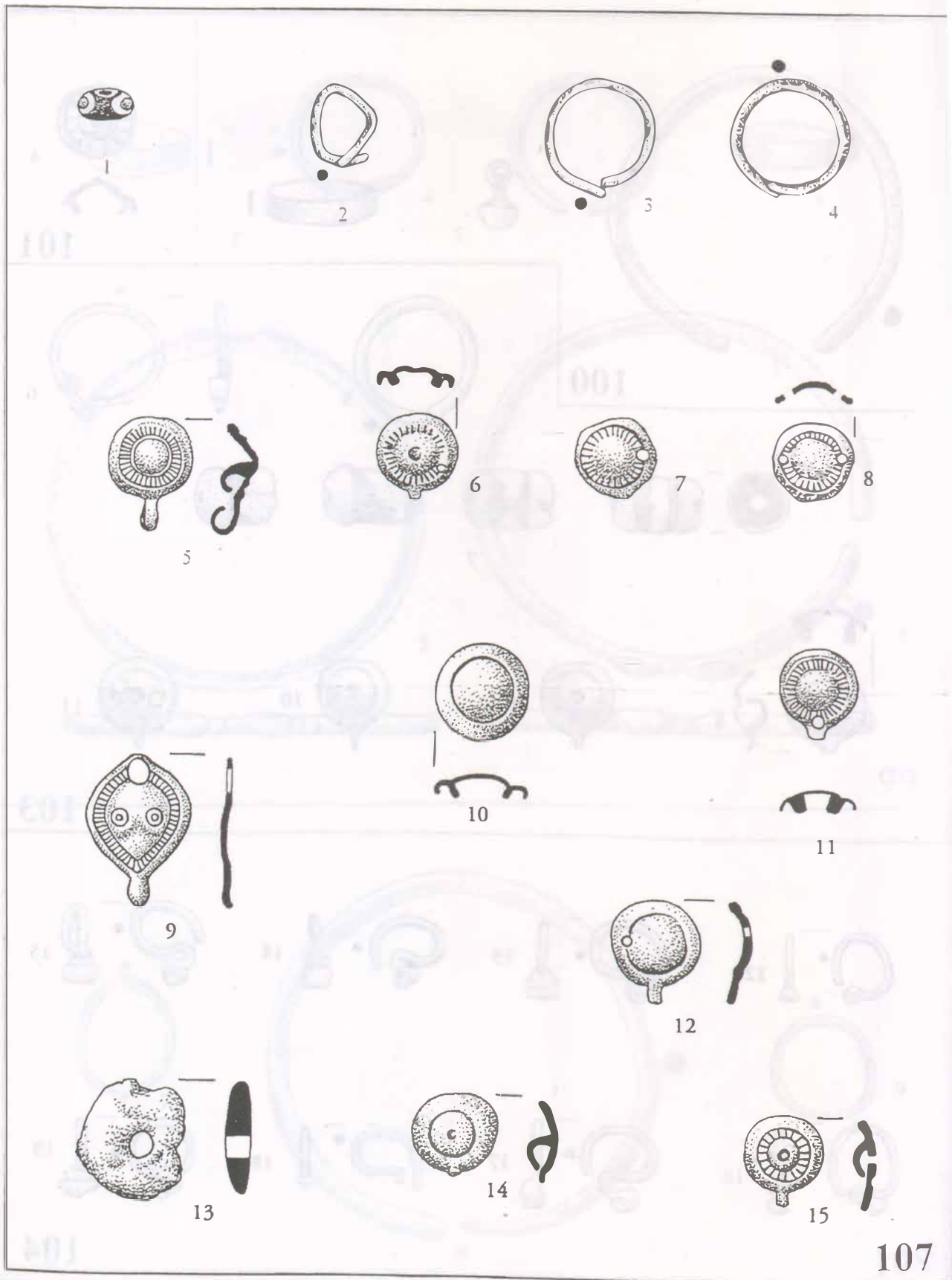

160. tábla: Püspökladány-Eperjesvölgy. 107. sír (1:1)

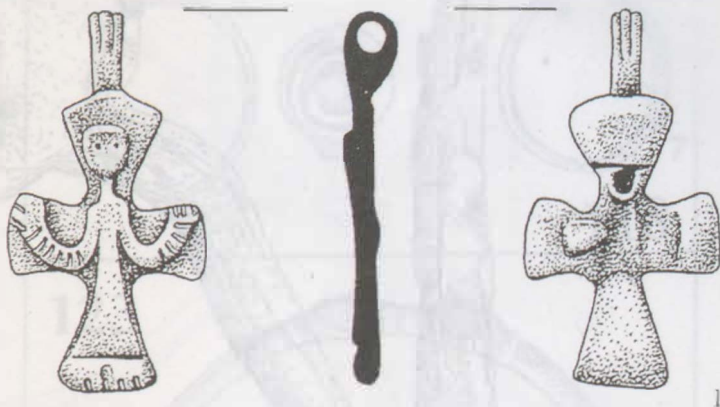

1

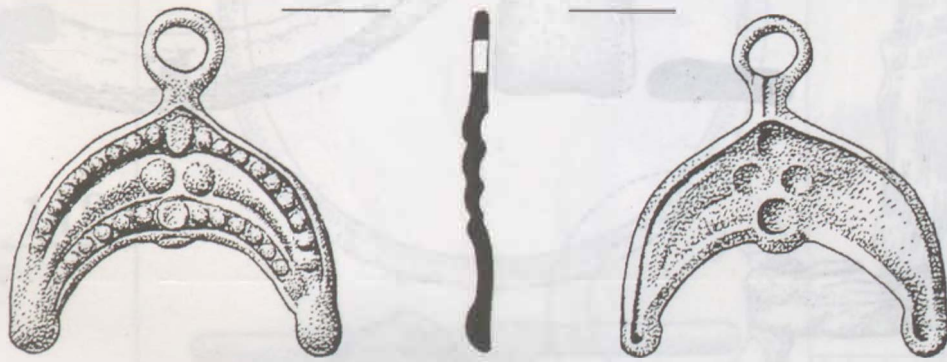

2



3

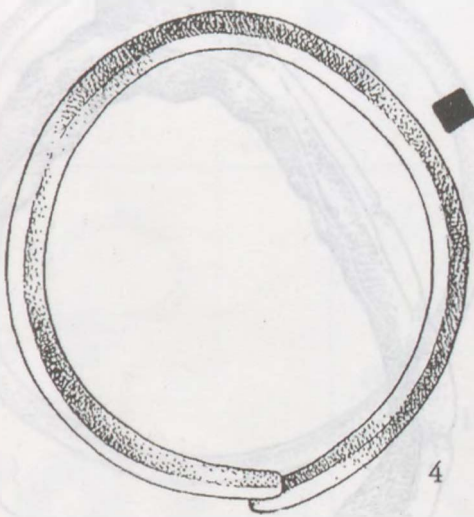

4

107

161. tábla: Püspökladány-Eperjesvölgy. 107. sír (1:1)

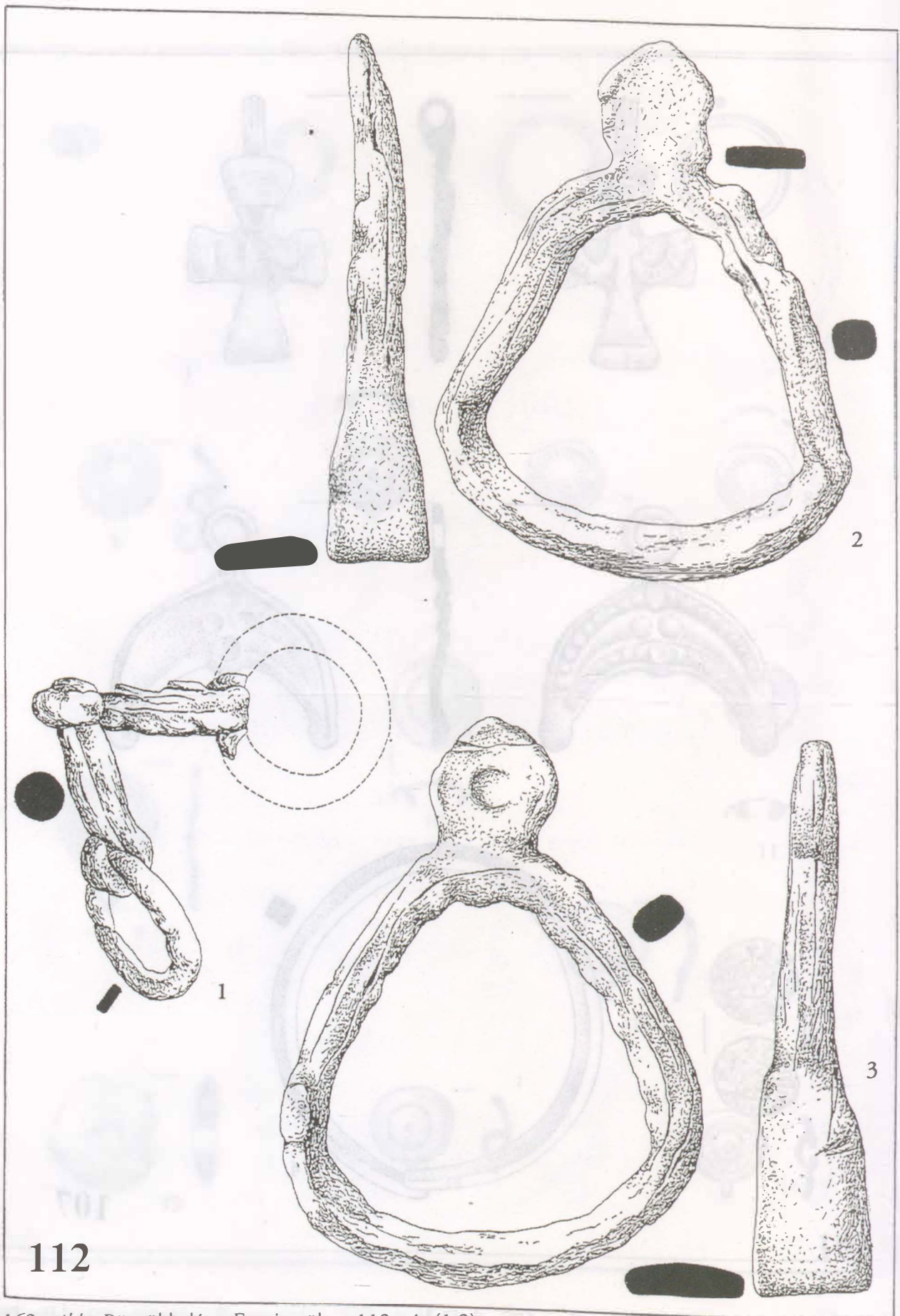

112

162. tábla: Püspökladány-Eperjesvölgy. 112. sír (1:2)

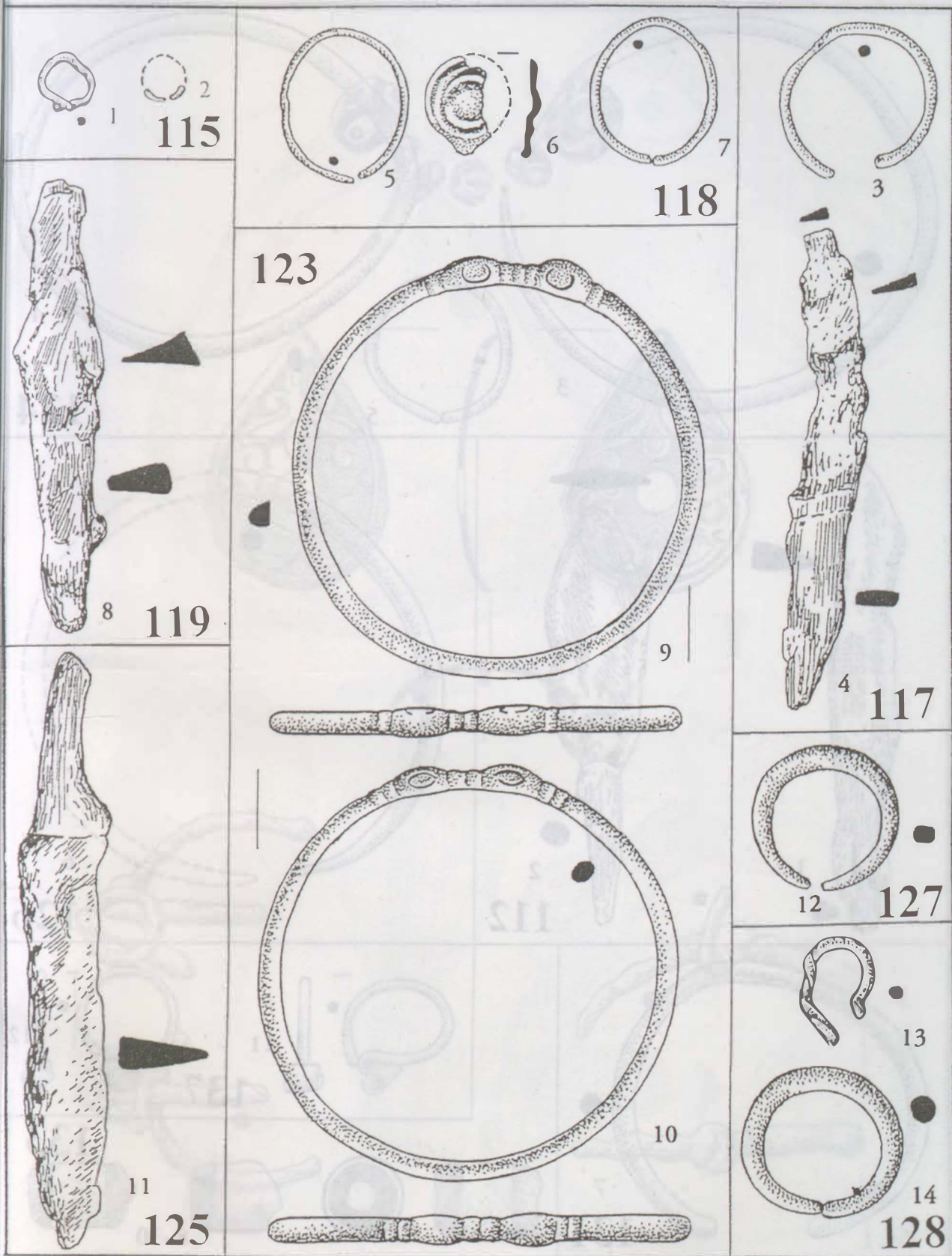

163. tábla: Püspökladány-Eperjesvölgy. 115., 117–119., 123., 125., 127–128. sír (1:1)

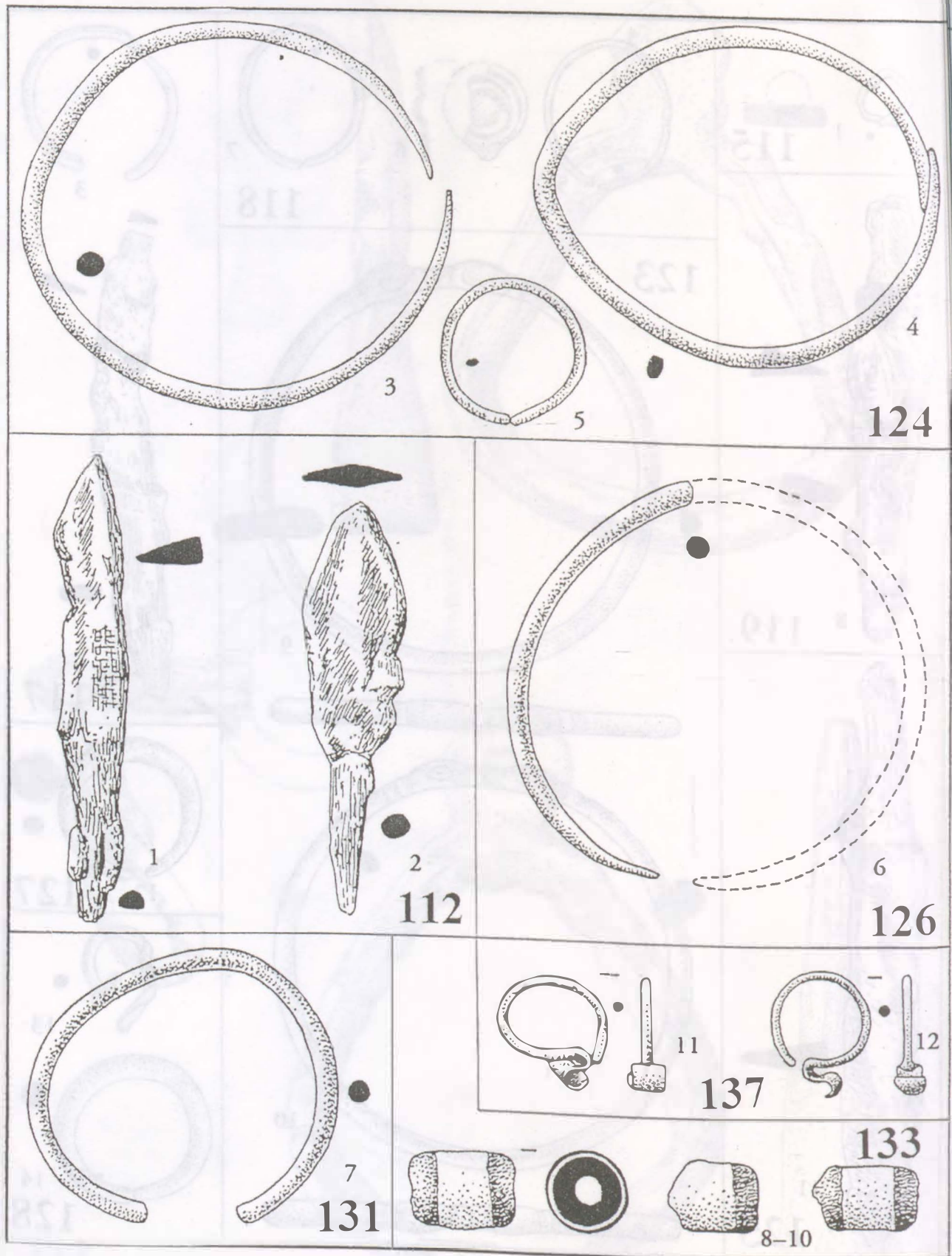

164. tábla: Püspökladány-Eperjesvölgy. 112., 124., 126., 131., 133., 137. sír (1:1)

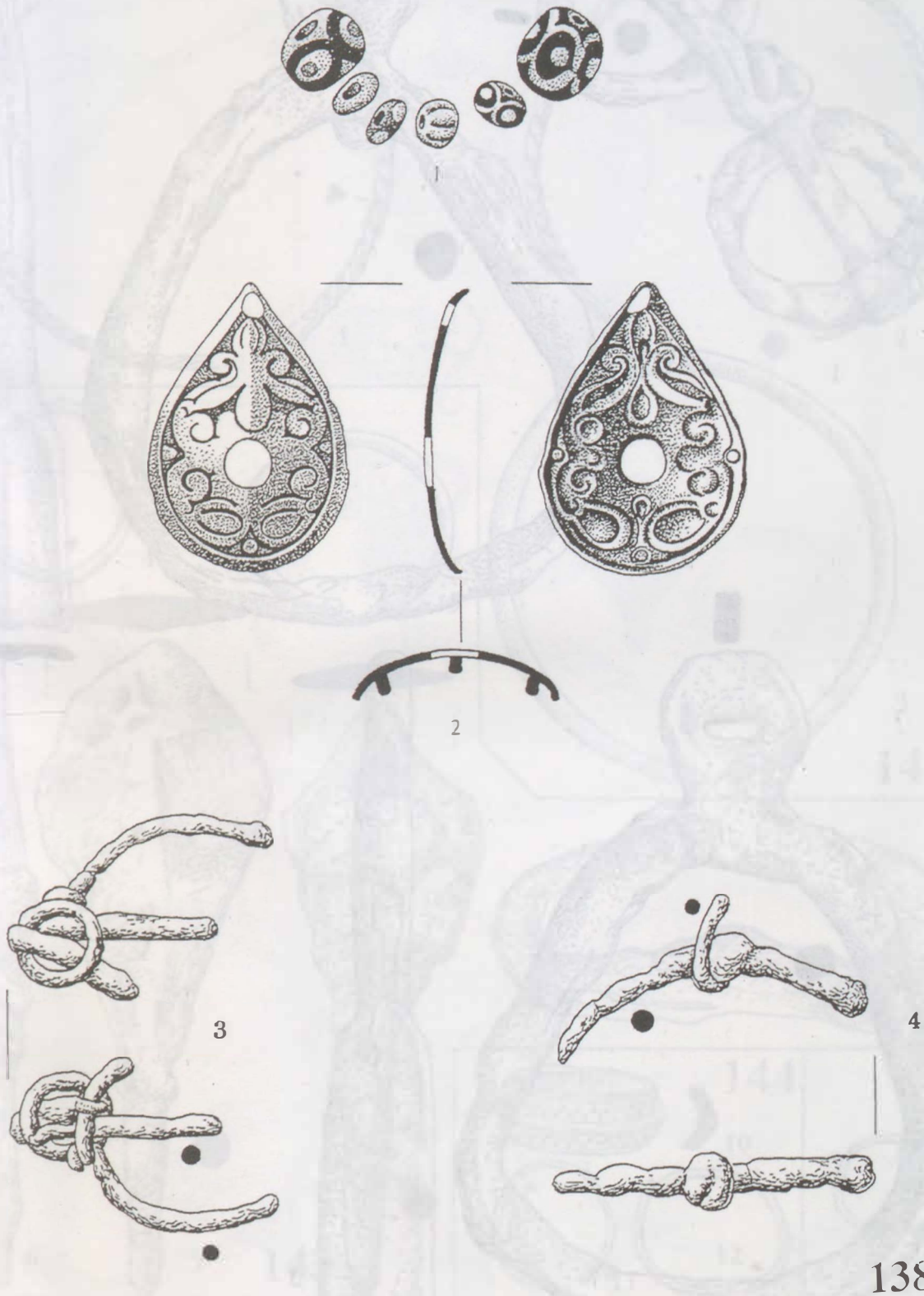

165. tábla: Püspökladány-Eperjesvölgy. 138. sír (1:1)

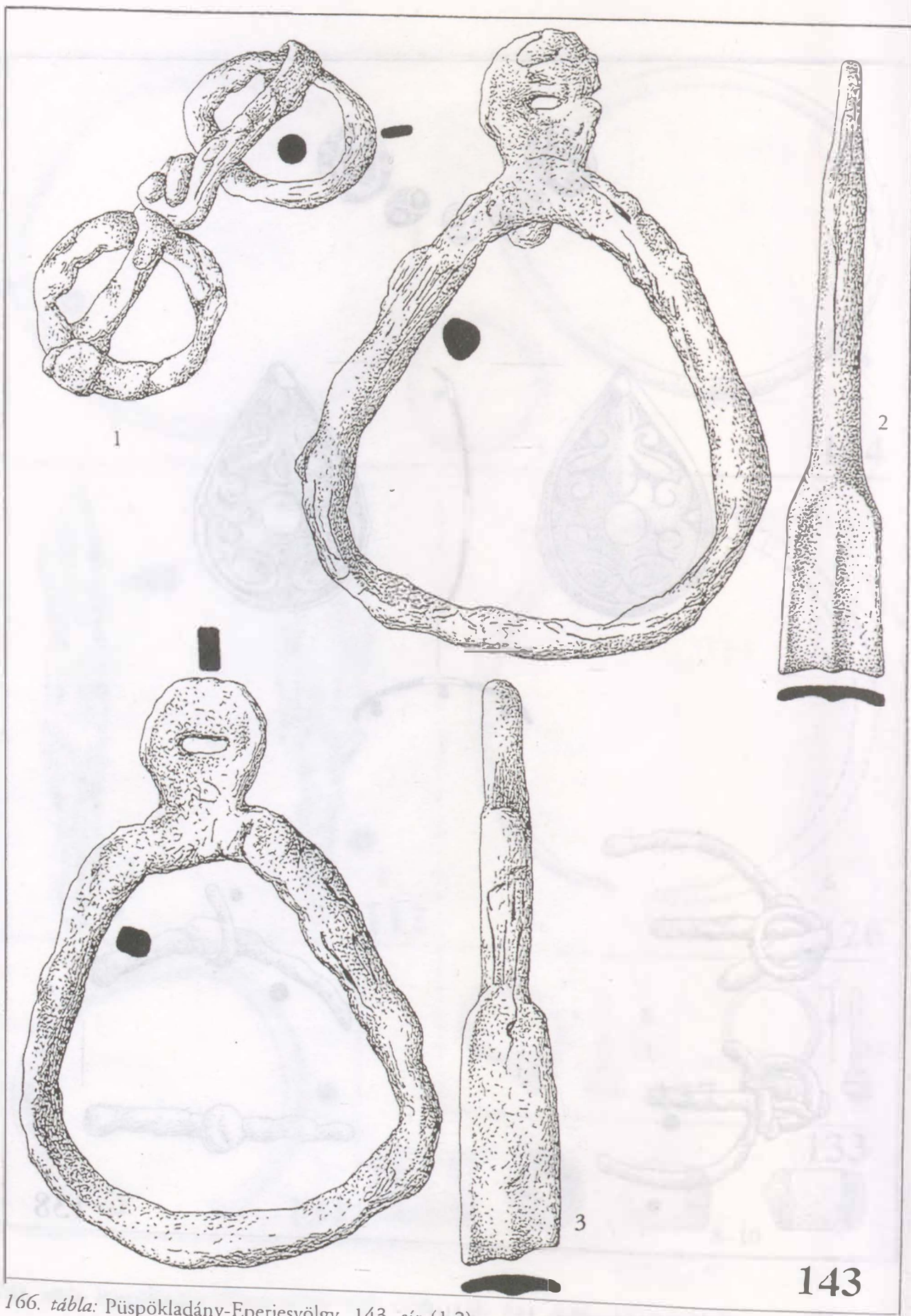

166. tábla: Püspökladány-Eperjesvölgy. 143. sír (1:2)

143

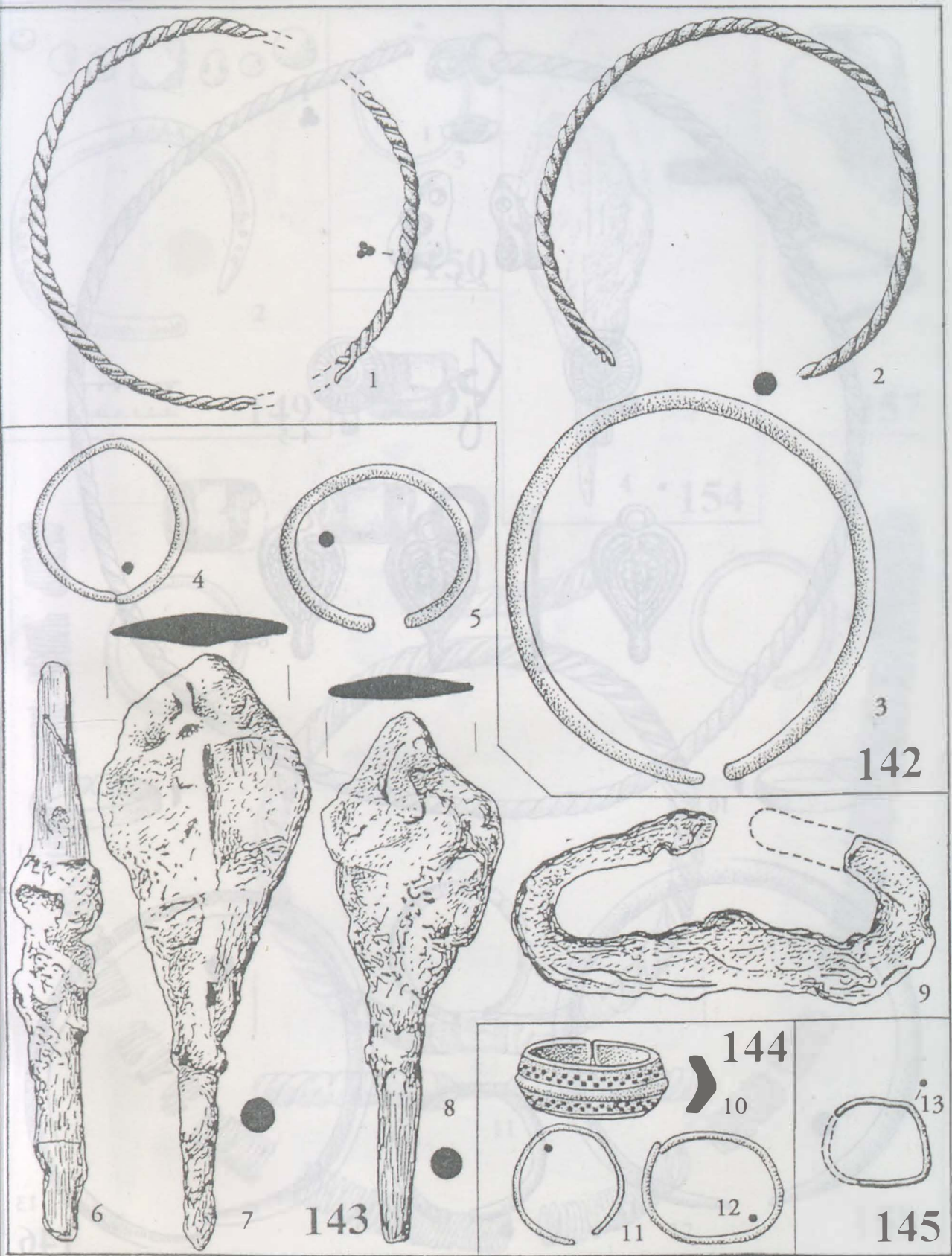

167. tábla: Püspökladány-Eperjesvölgy. 142-145. sír (1:1)

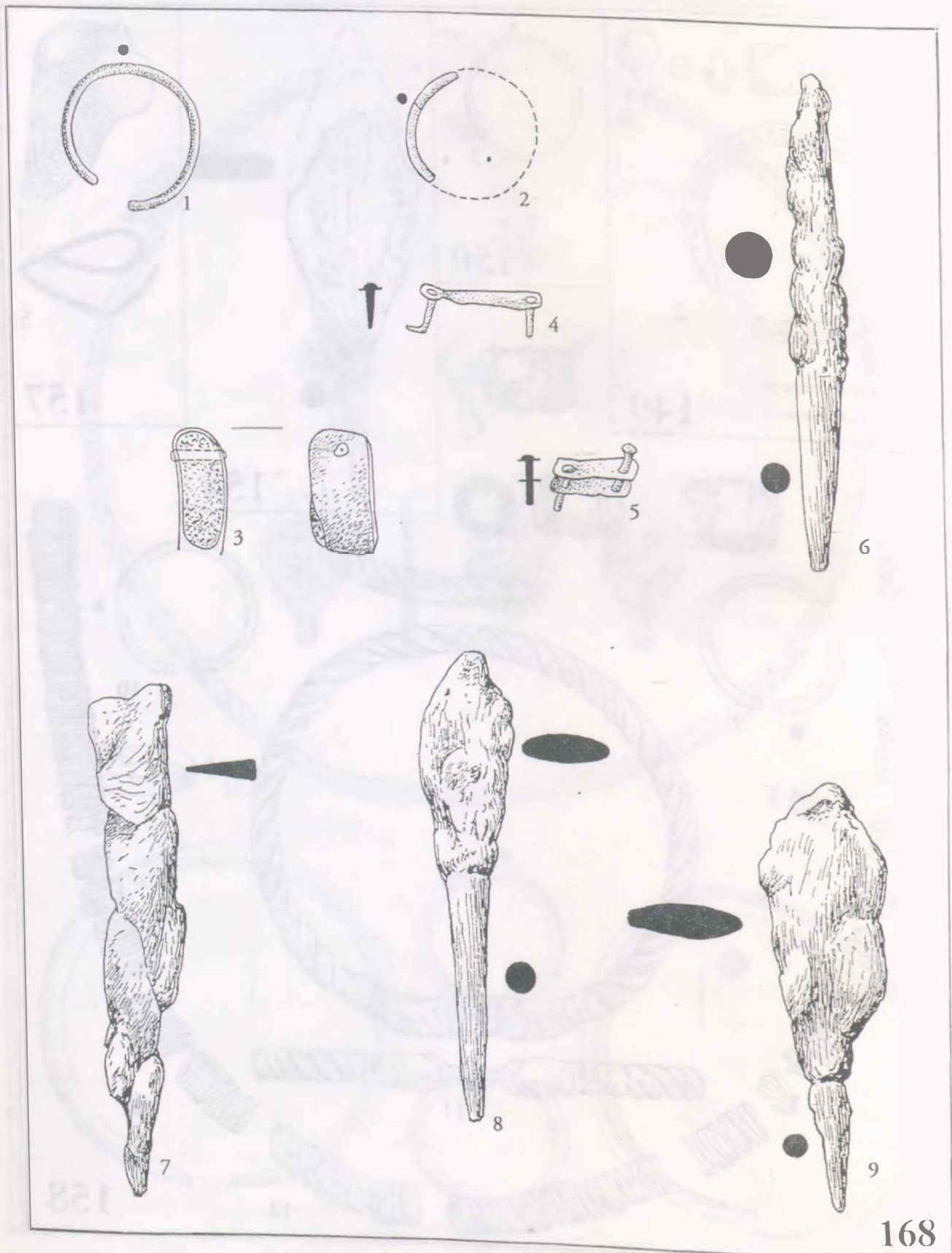

168

170. tábla: Püspökladány-Eperjesvölgy. 168. sír (1:1)



168



172

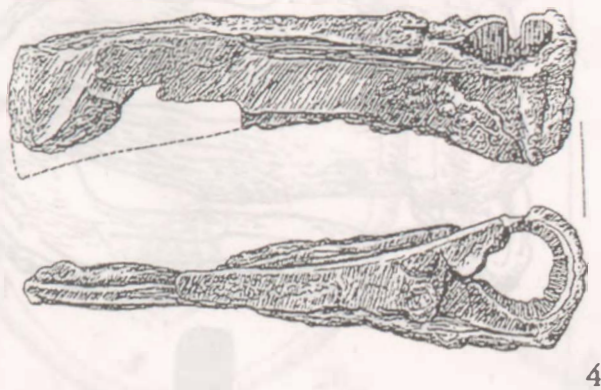

178

171. tábla: Püspökladány-Eperjesvölgy. 168., 172., 178. sír (1:2)

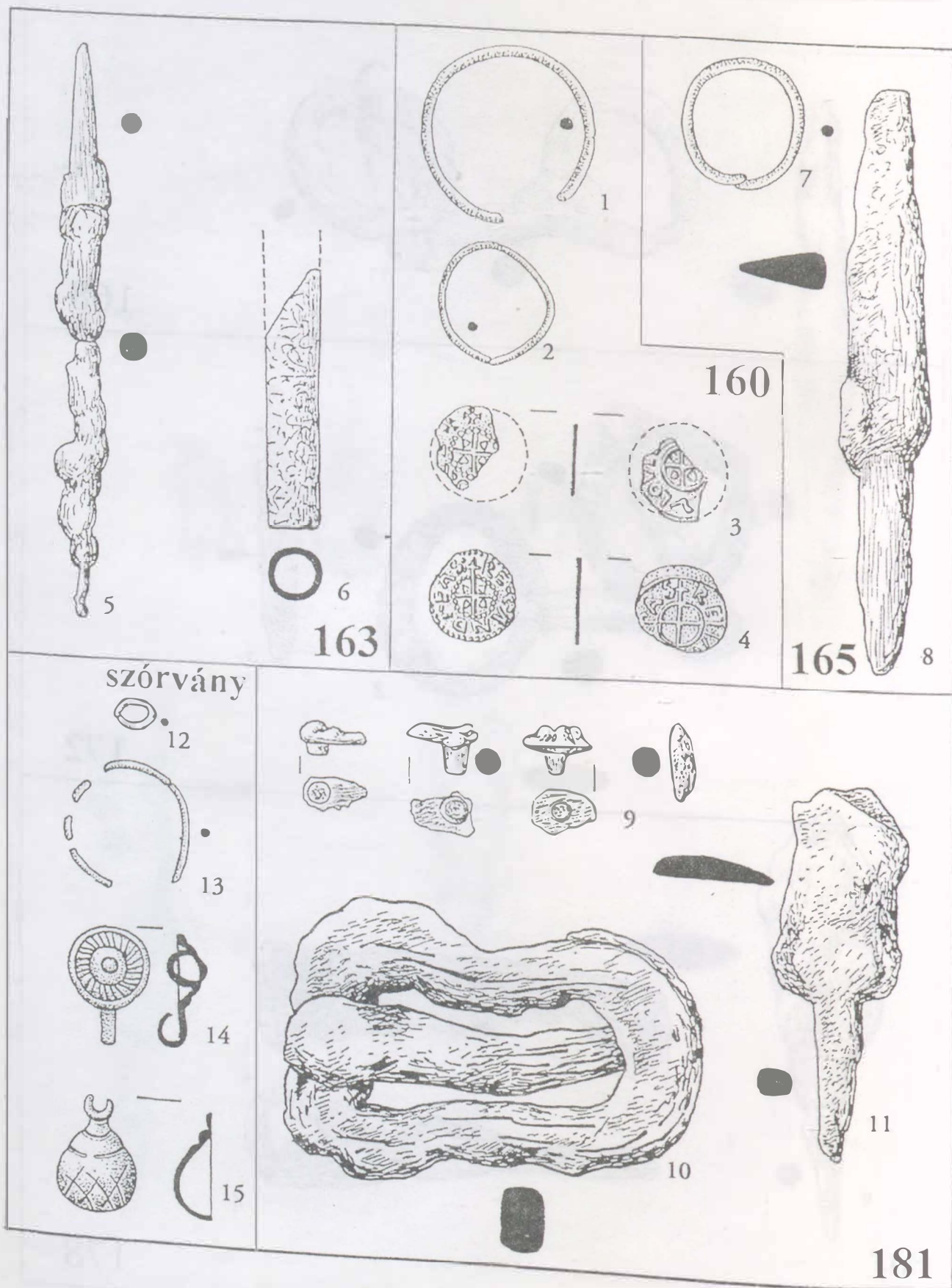

172. tábla: Püspökladány-Eperjesvölgy. 160., 163., 165., 181. sír és szórvány (1:1)

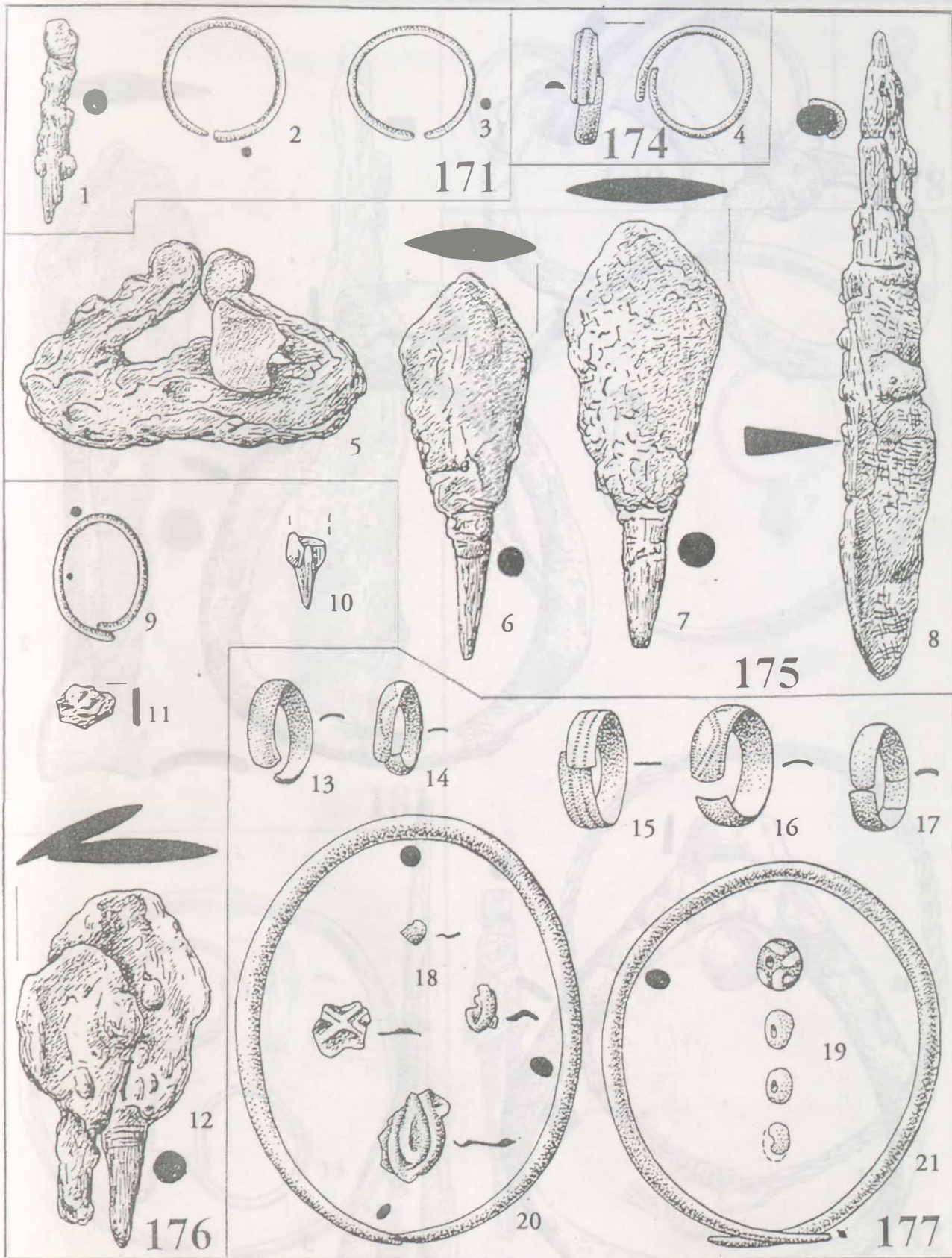

173. tábla: Püspökladány-Eperjesvölgy. 171., 174–177. sír (1:1)

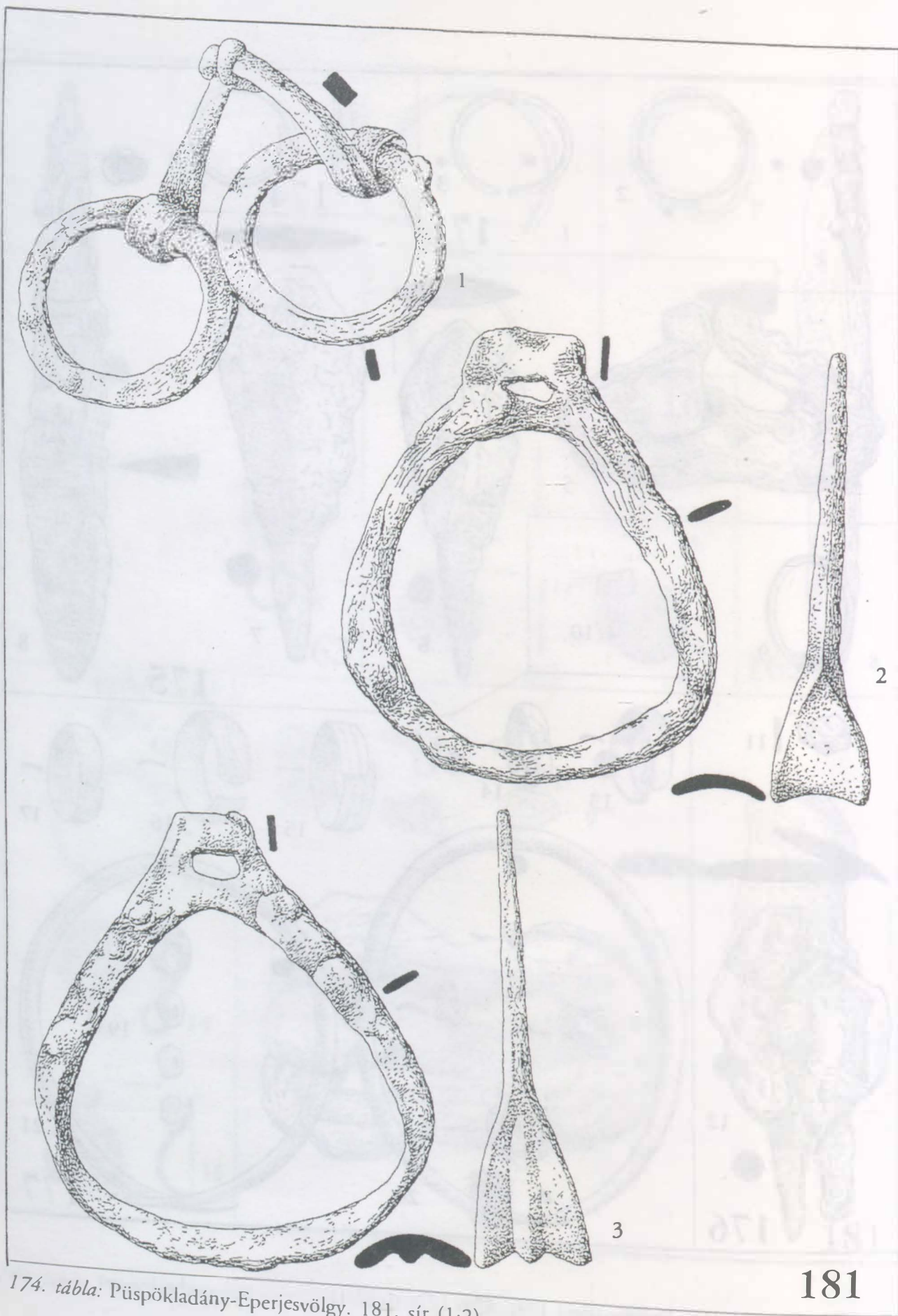

174. tábla: Püspökladány-Eperjesvölgy. 181. sír (1:2)

181

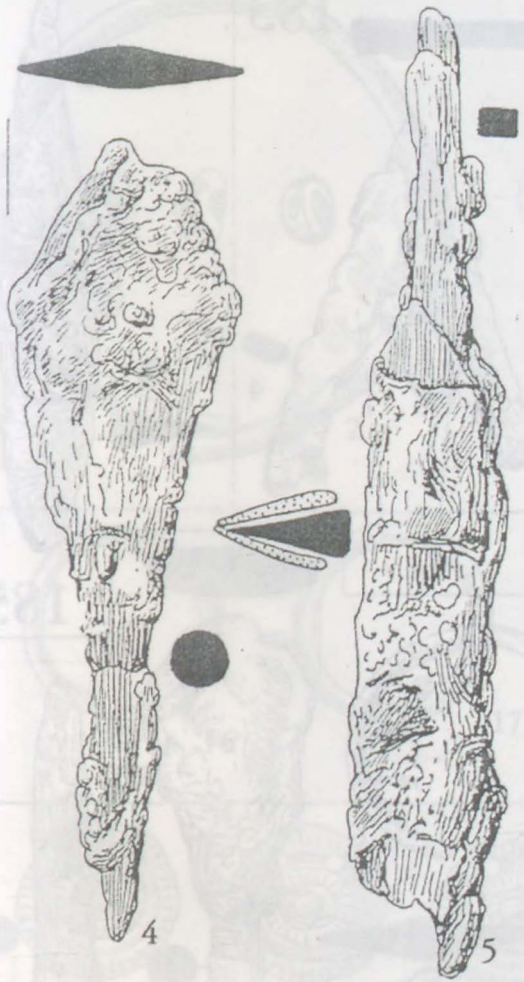

181



180



178

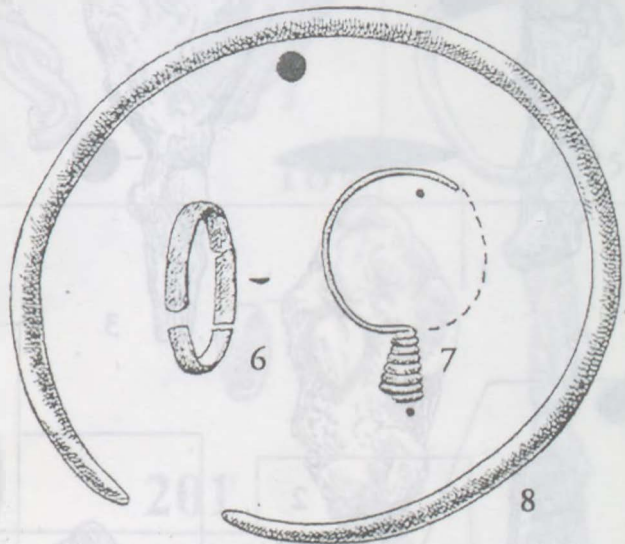

8

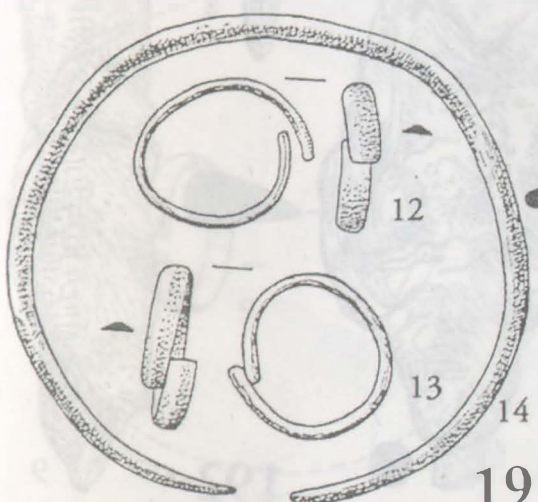

191



182

175. tábla: Püspökladány-Eperjesvölgy. 178., 180–182., 191. sír (1:1)

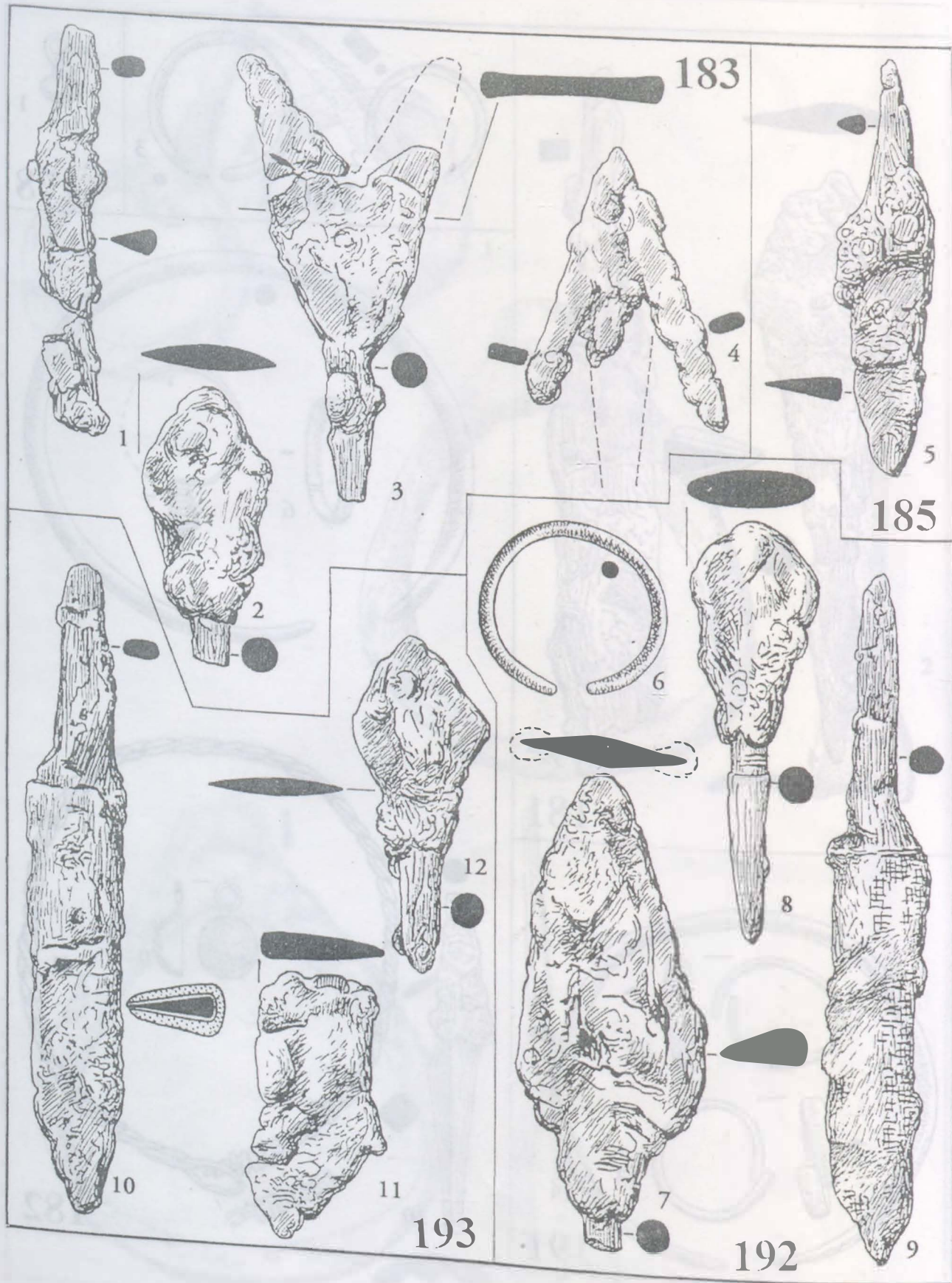

176. tábla: Püspökladány-Eperjesvölgy. 183., 185., 192–193. sír (1:1)

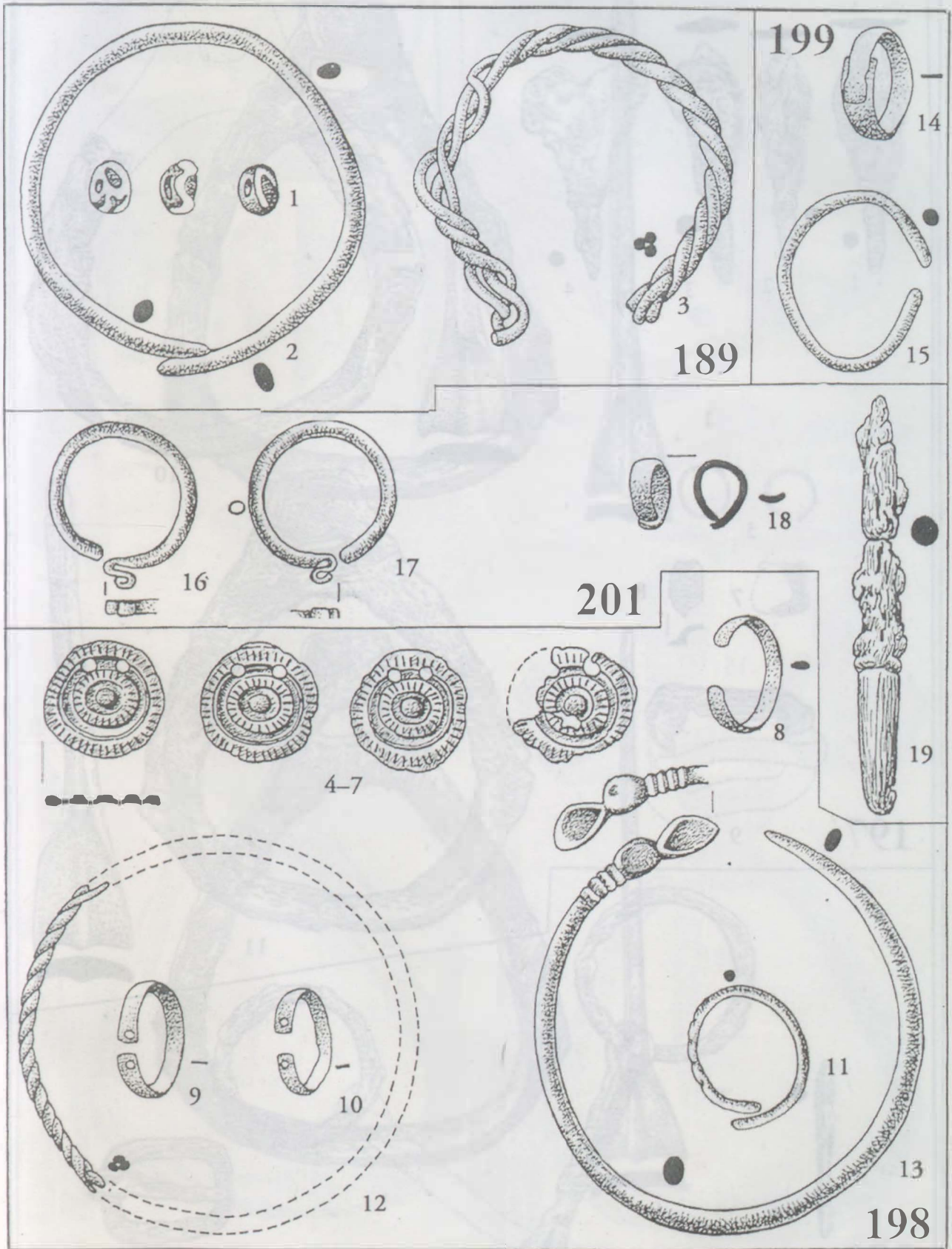

177. tábla: Püspökladány-Eperjesvölgy. 189., 198–199., 201. sír (1:1)

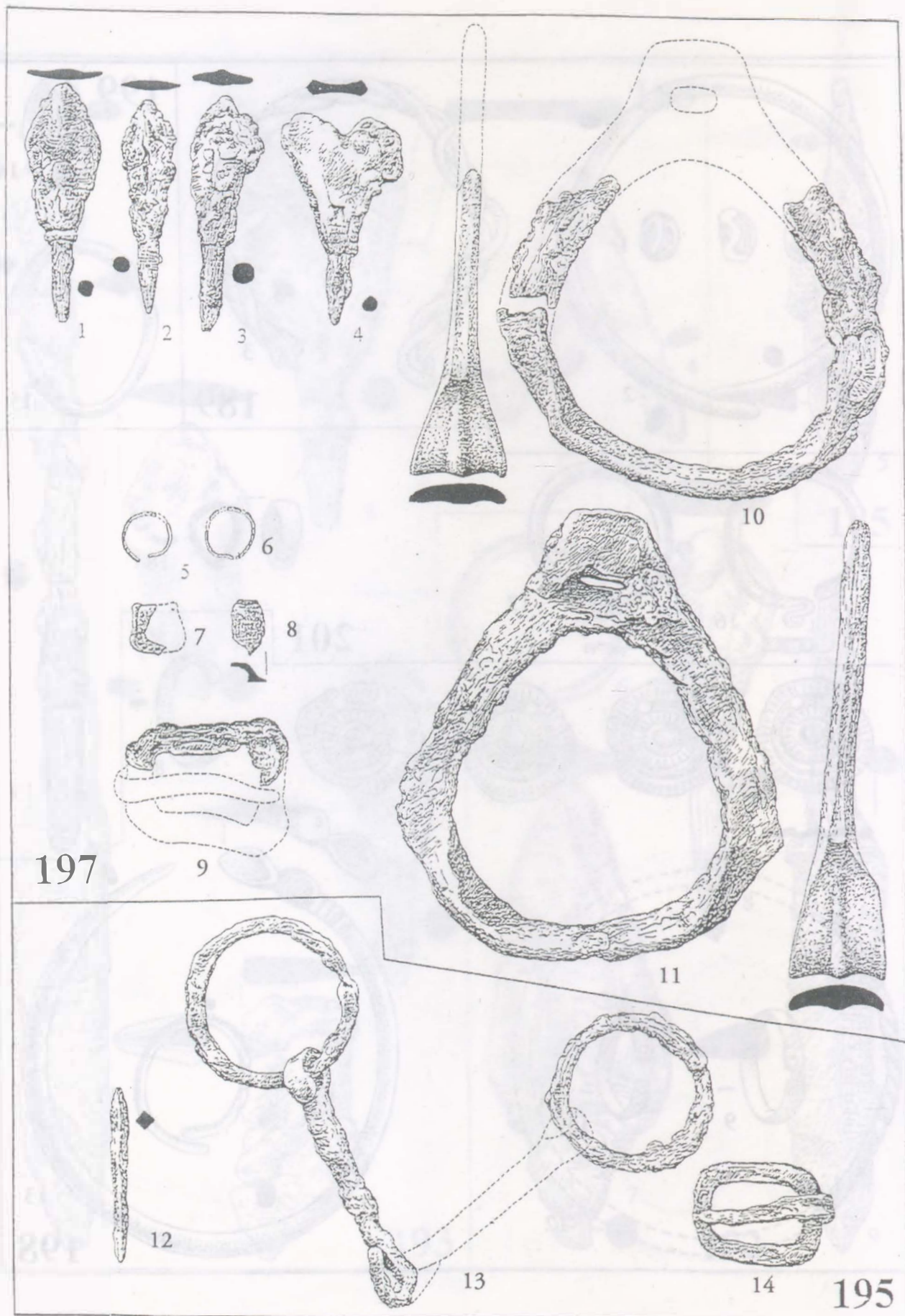

178. tábla: Püspökladány-Eperjesvölgy. 195., 197. sír (1:2)

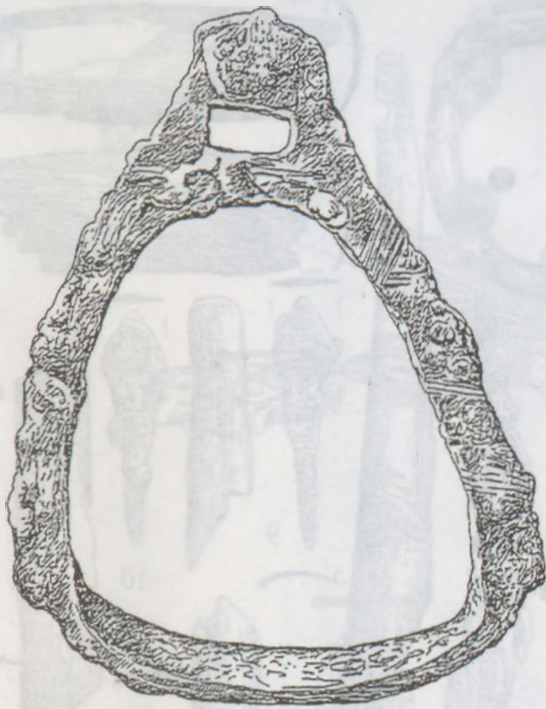

1

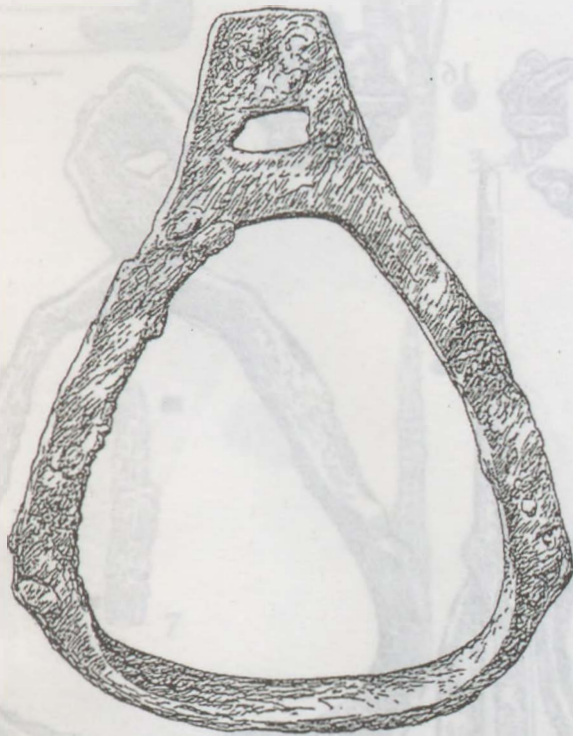

2

195

179. tábla: Püspökladány-Eperjesvölgy. 195. sír (1:2)

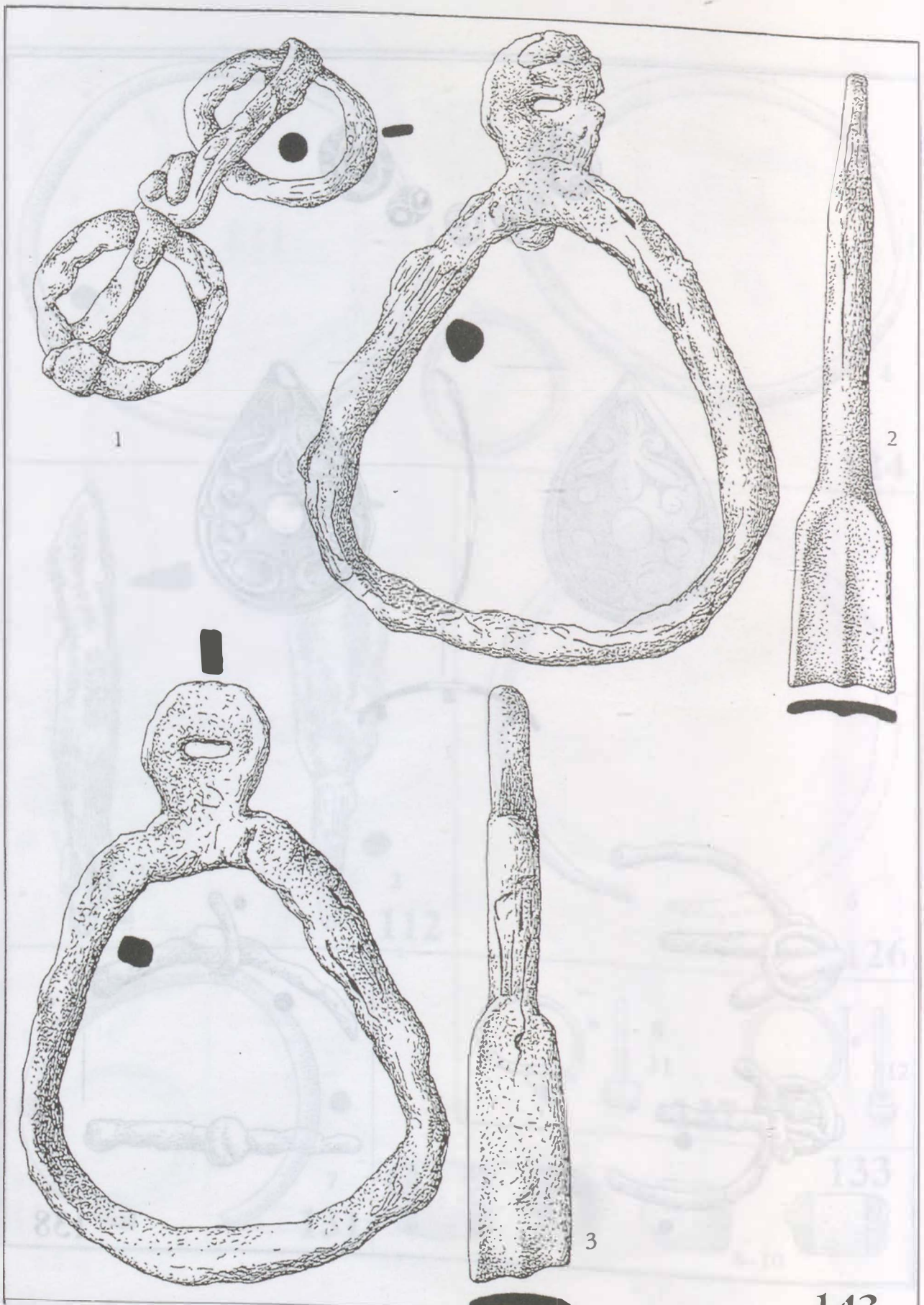

166. tábla: Püspökladány-Eperjesvölgy. 143. sír (1:2)

143

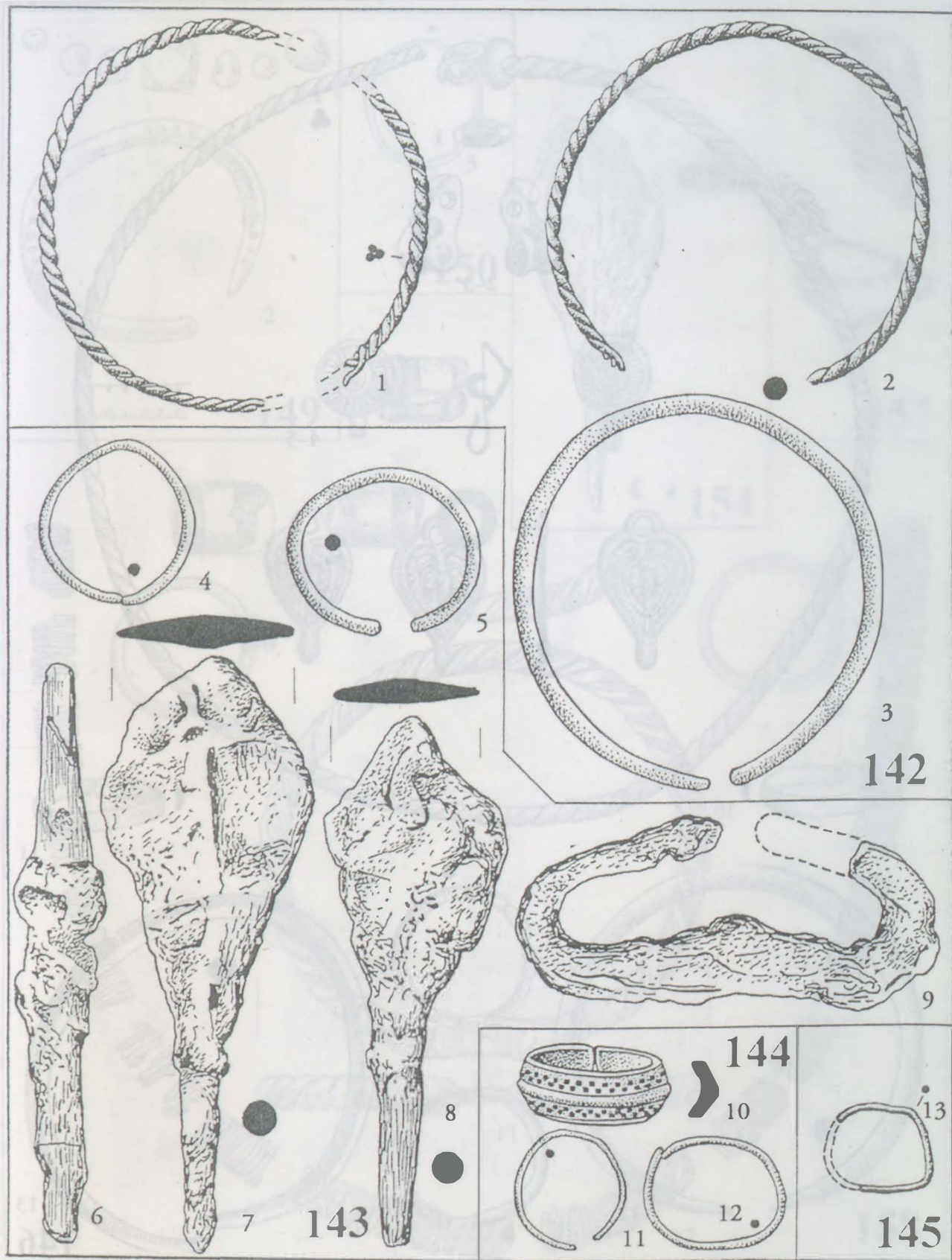

167. tábla: Püspökladány-Eperjesvölgy. 142–145. sír (1:1)

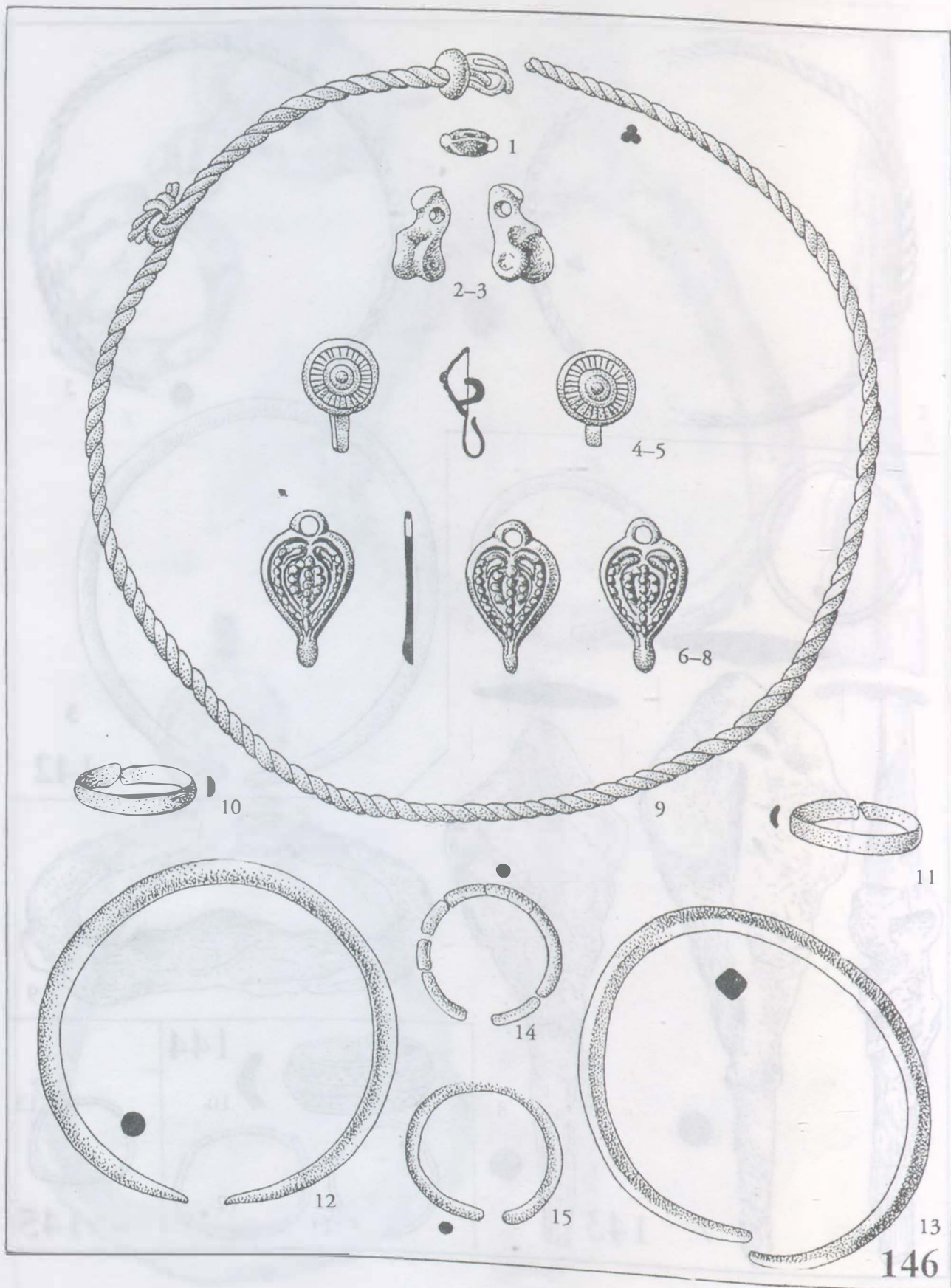

168. tábla: Püspökladány-Eperjesvölgy. 146. sír (1:1)

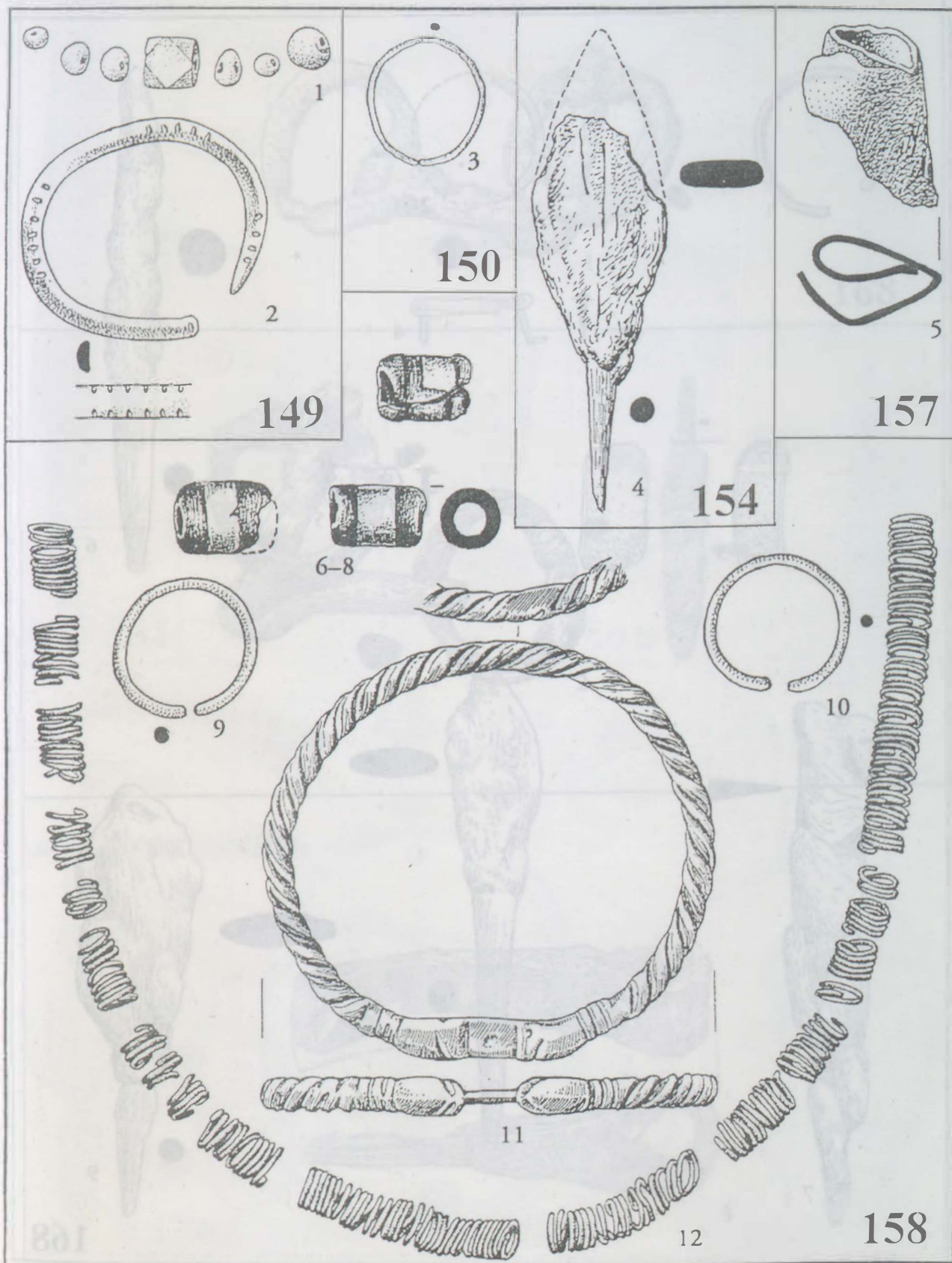

169. tábla: Püspökladány-Eperjesvölgy. 149–150., 154., 157–158. sír (1:1)

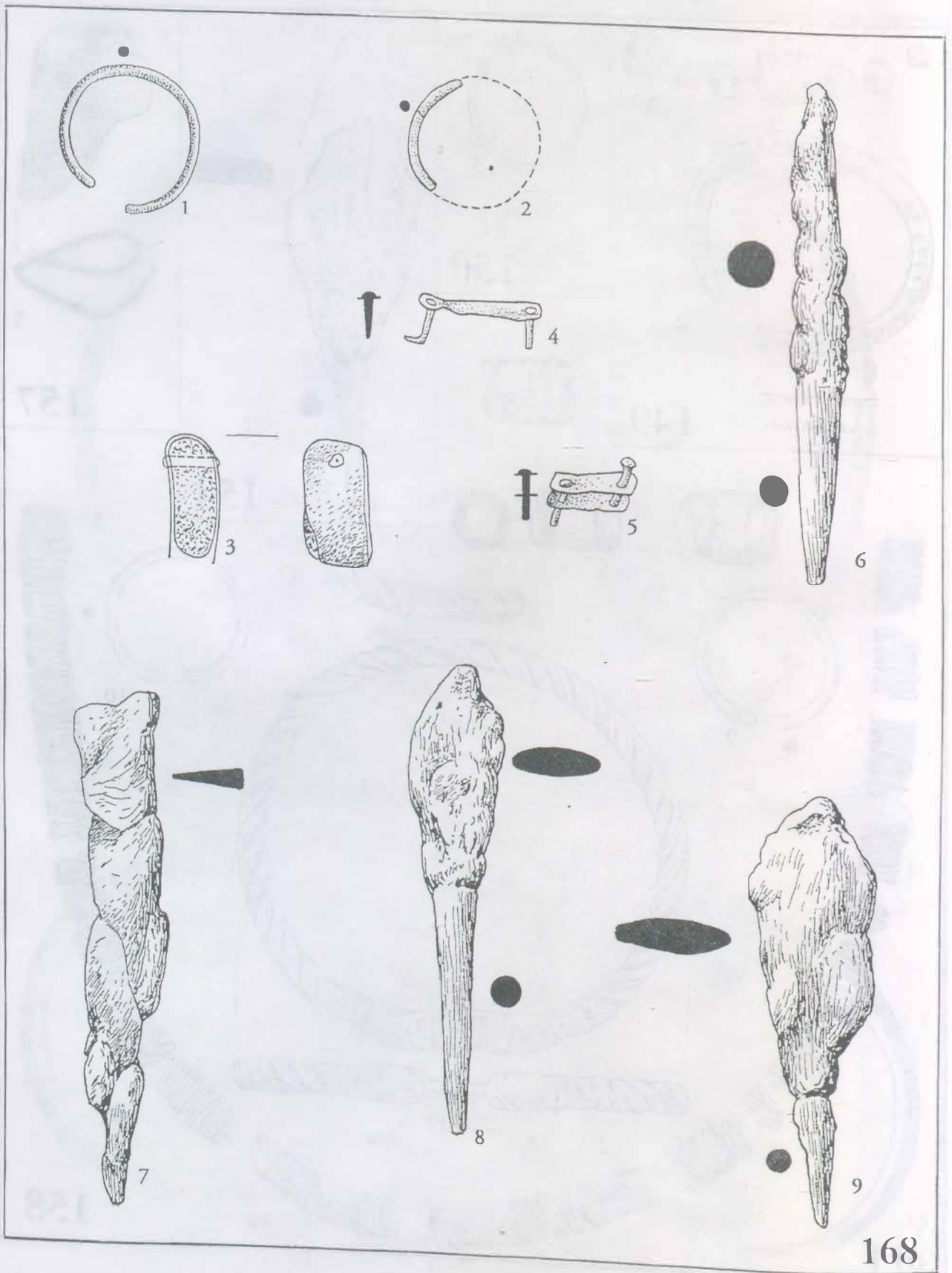

168

170. tábla: Püspökladány-Eperjesvölgy. 168. sír (1:1)

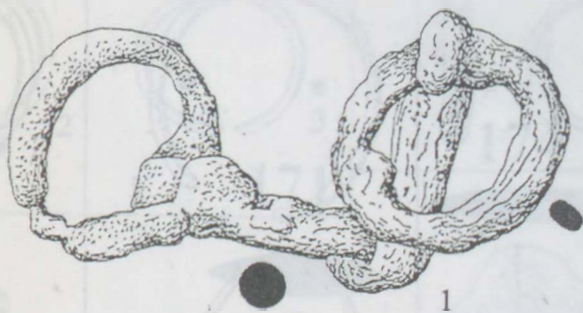

168



172

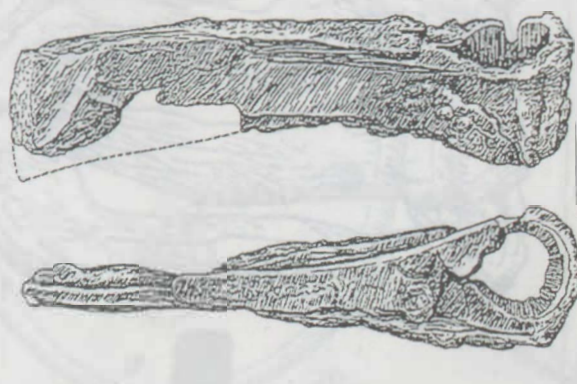

178

171. tábla: Püspökladány-Eperjesvölgy. 168., 172., 178. sír (1:2)

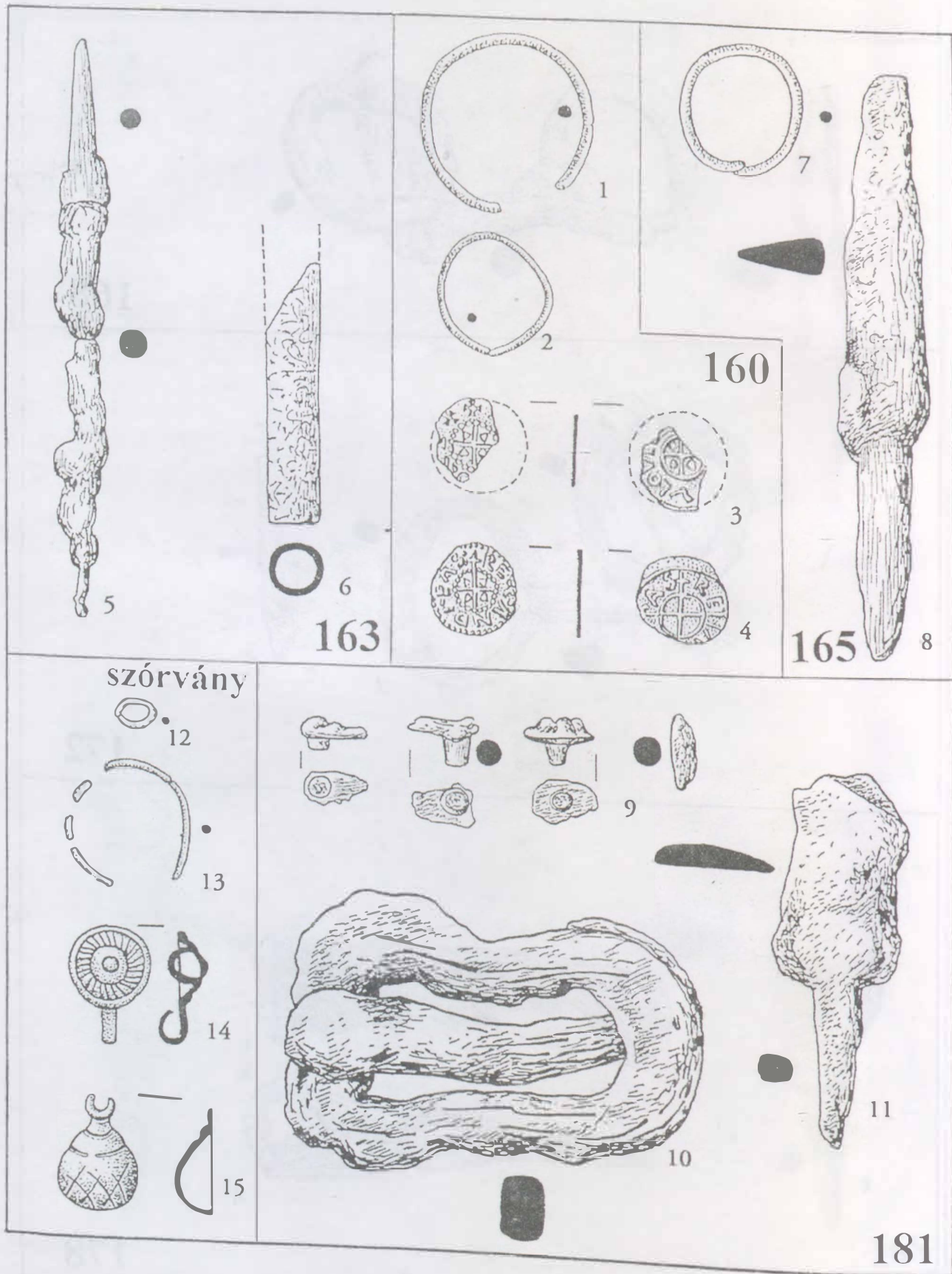

172. tábla: Püspökladány-Eperjesvölgy. 160., 163., 165., 181. sír és szórvány (1:1)

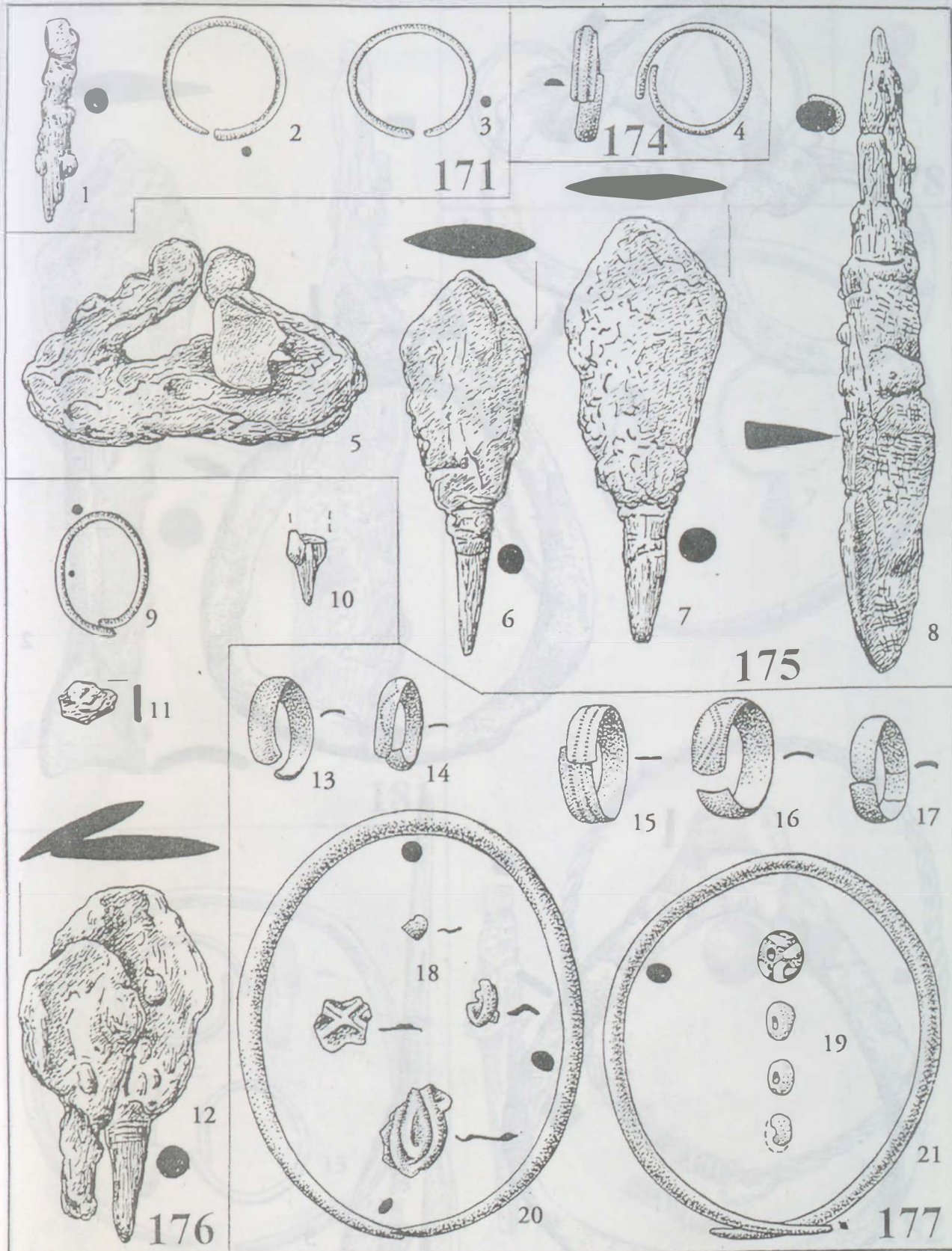

173. tábla: Püspökladány-Eperjesvölgy. 171., 174–177. sír (1:1)

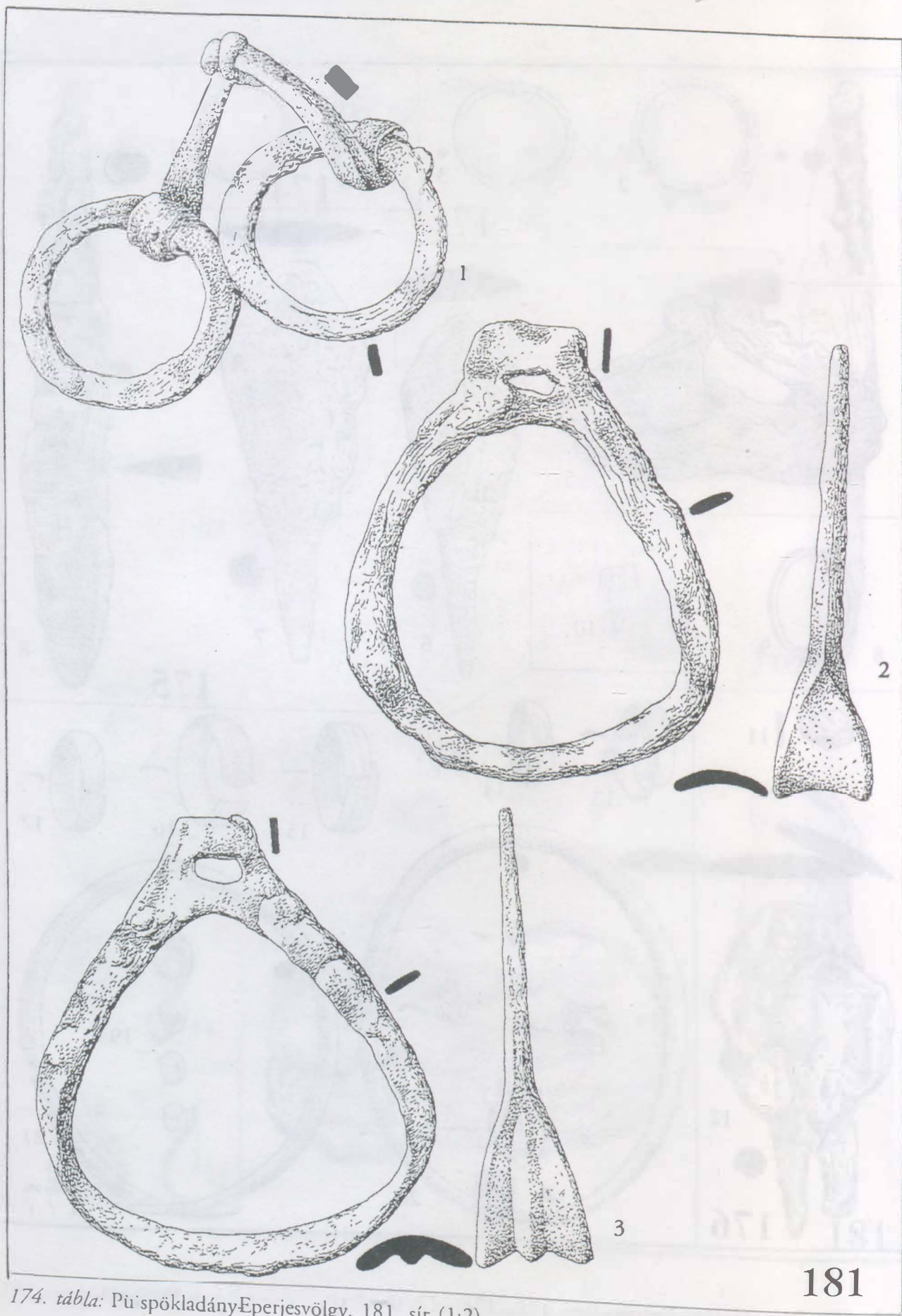

174. tábla: Püspökladány-Eperjesvölgy. 181. sír (1:2)

181

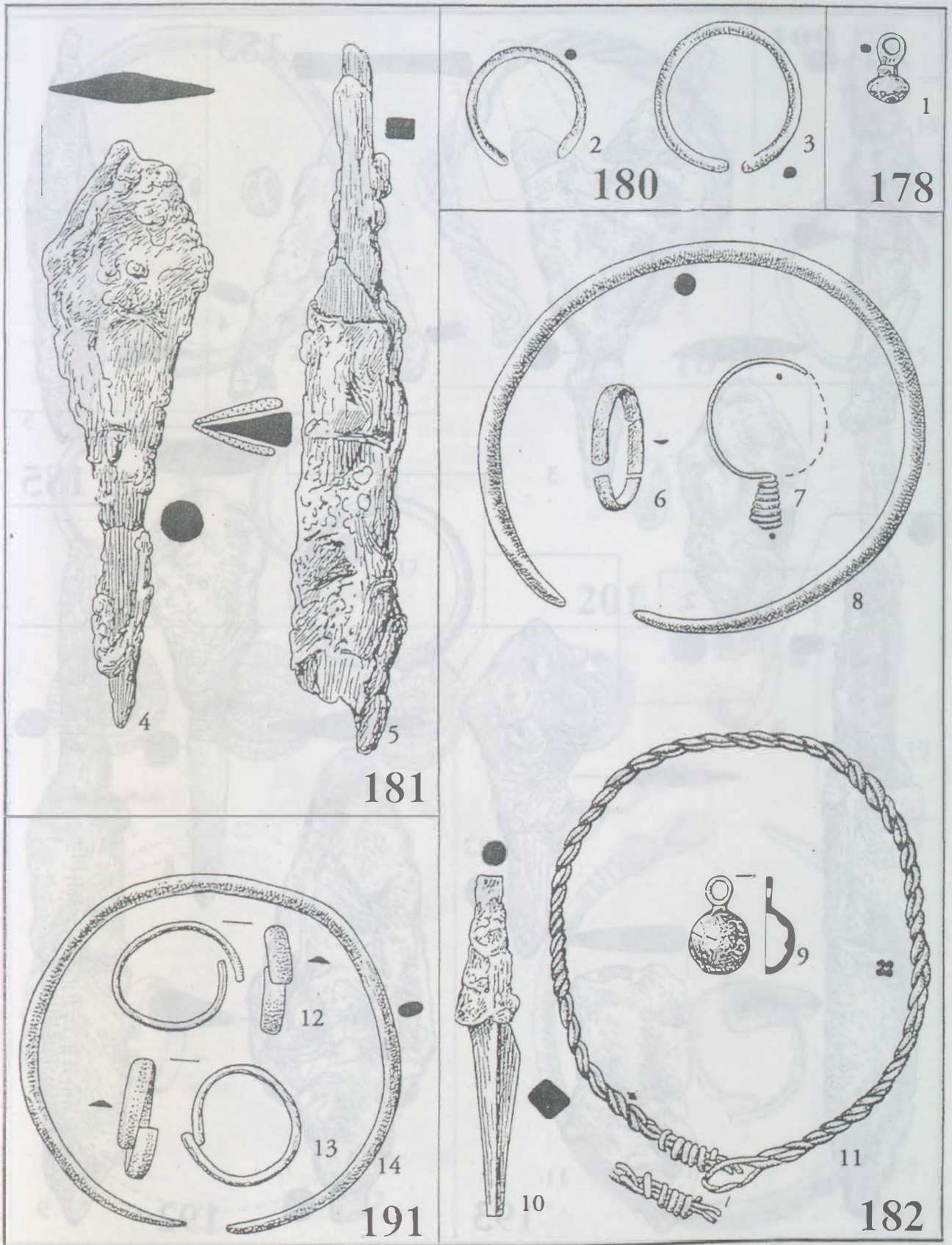

175. tábla: Püspökladány-Eperjesvölgy. 178., 180–182., 191. sír (1:1)

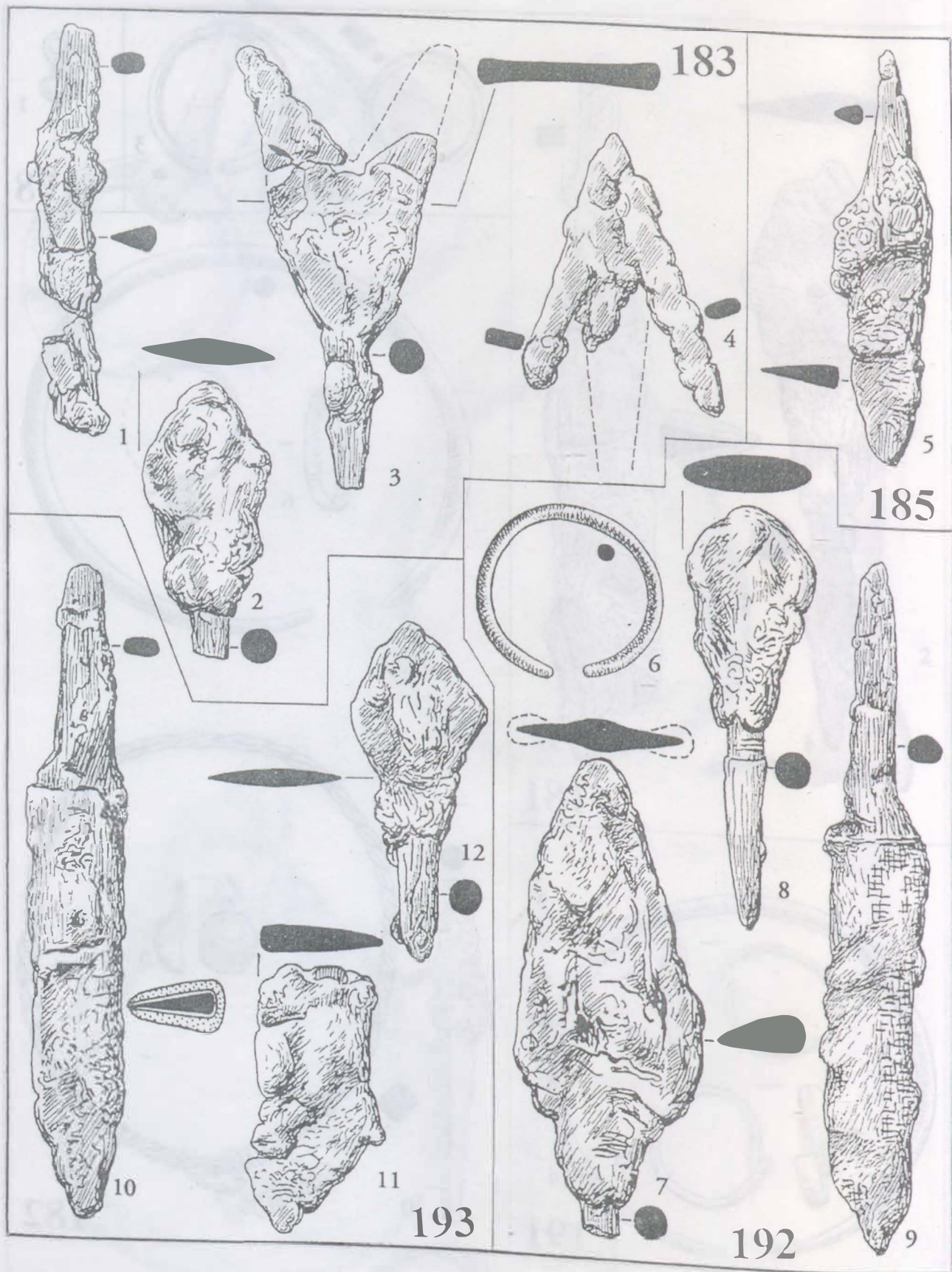

176. tábla: Püspökladány-Eperjesvölgy. 183., 185., 192–193. sír (1:1)

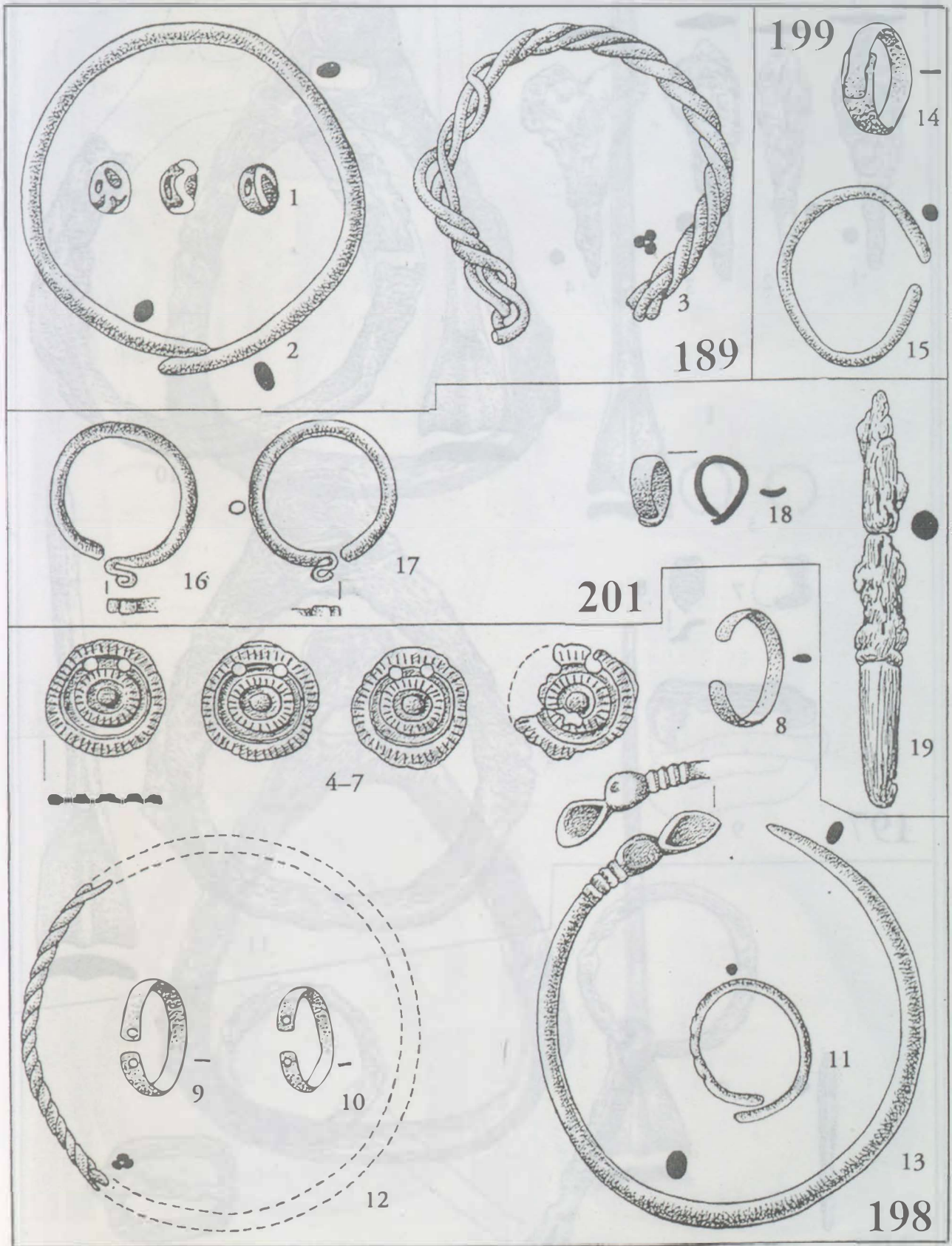

177. tábla: Püspökladány-Eperjesvölgy. 189., 198-199., 201. sír (1:1)

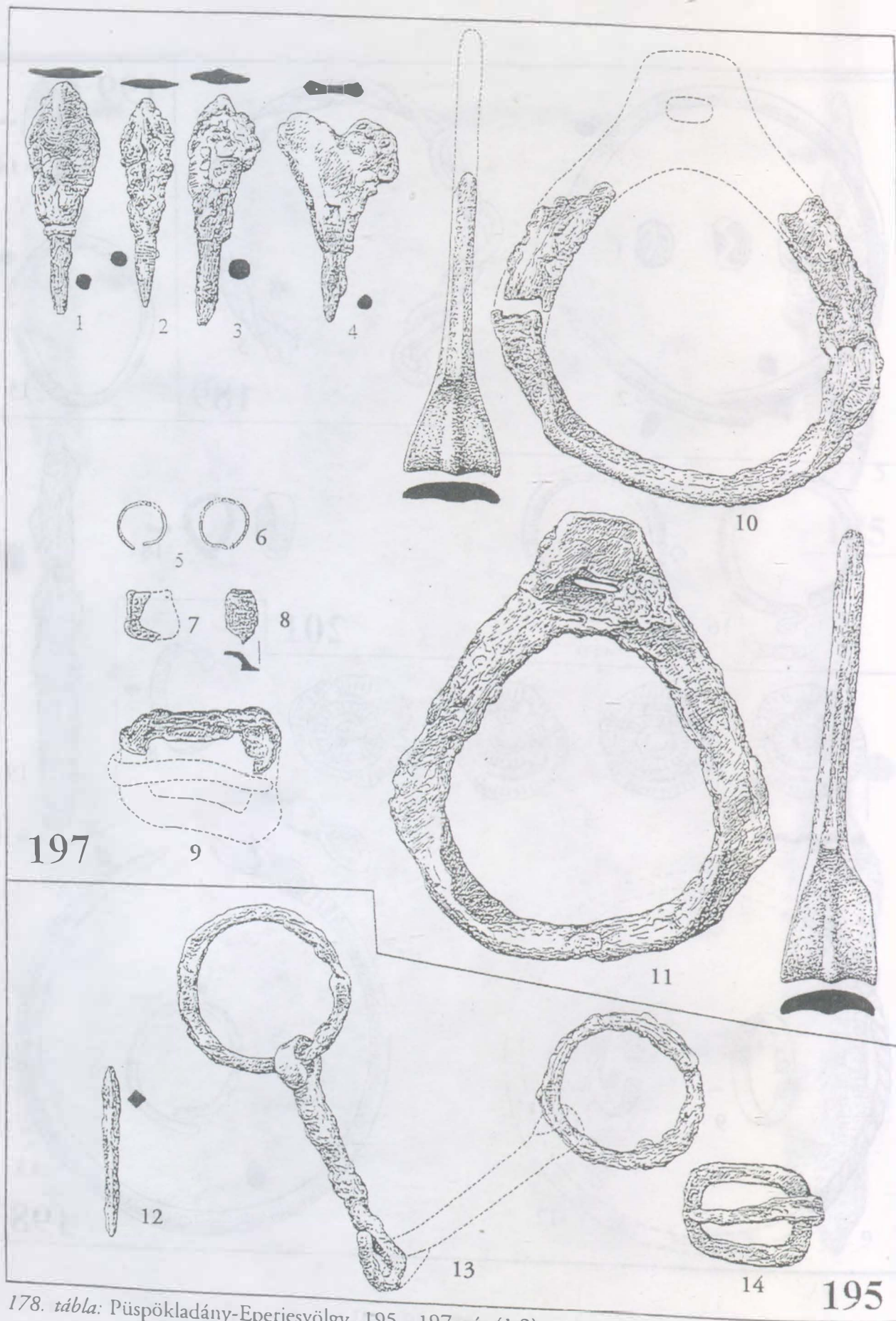

178. tábla: Püspökladány-Eperjesvölgy. 195., 197. sír (1:2)

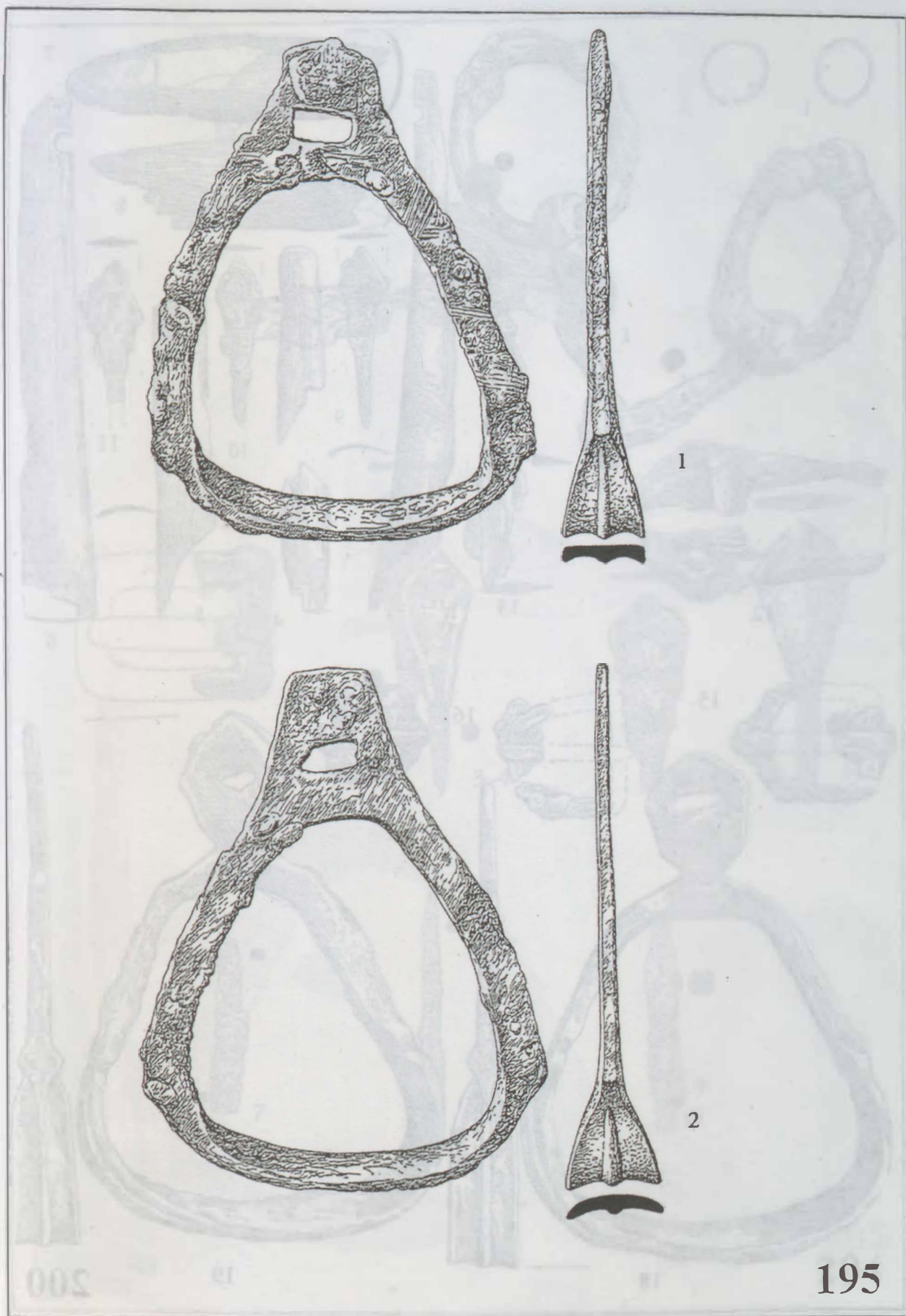

179. tábla: Püspökladány-Eperjesvölgy. 195. sír (1:2)

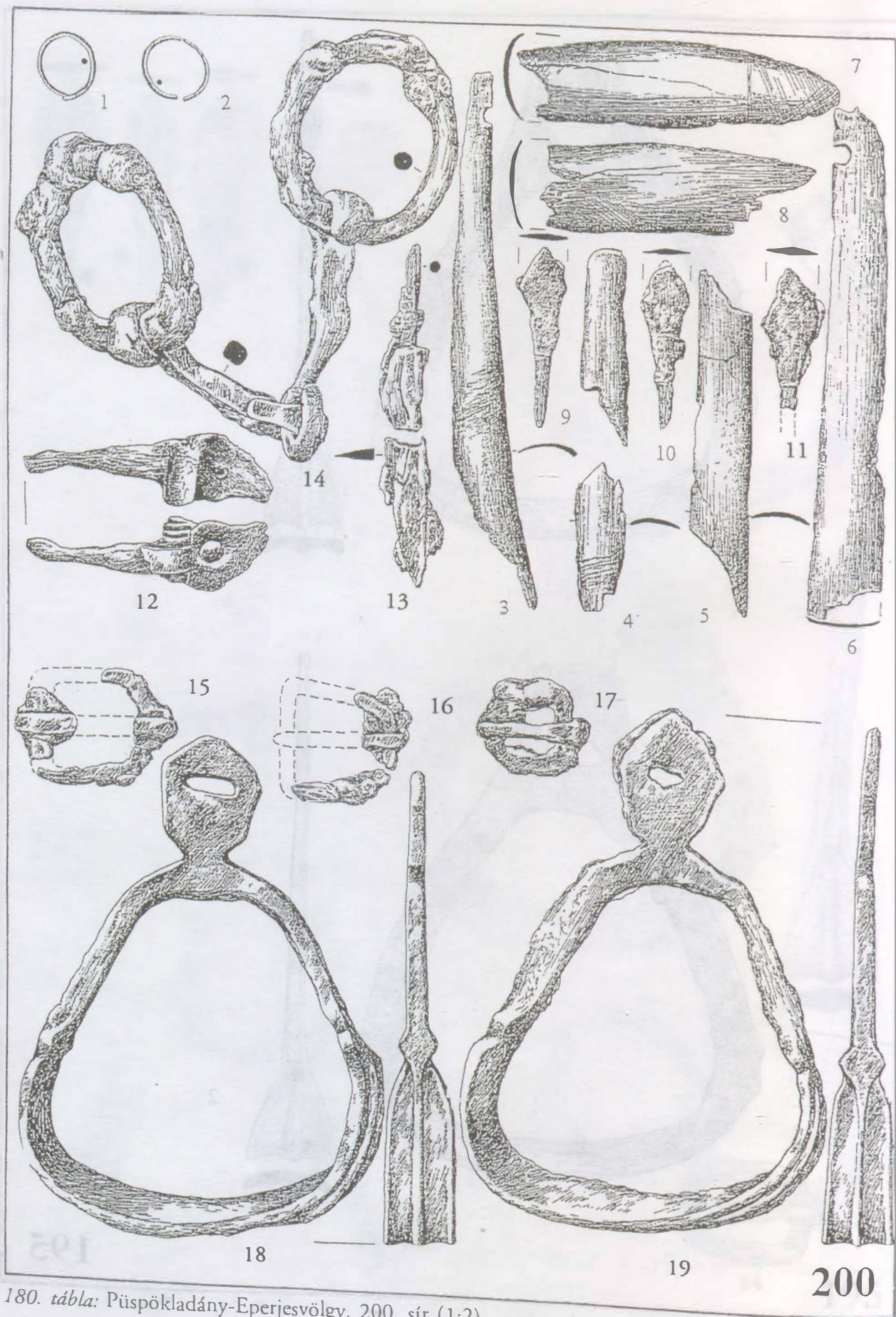

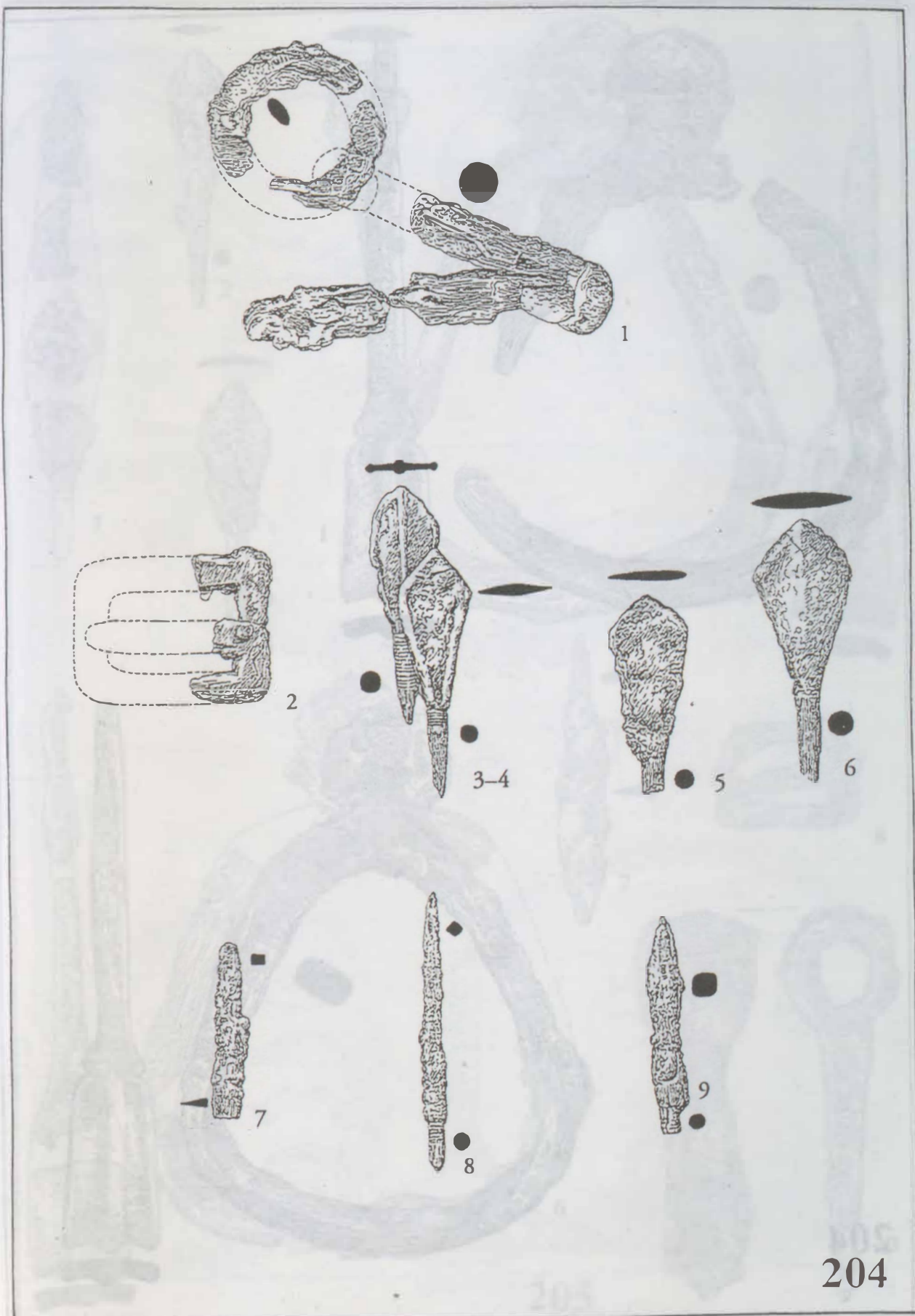

204

181. tábla: Püspökladány-Eperjesvölgy. 204. sír (1:2)

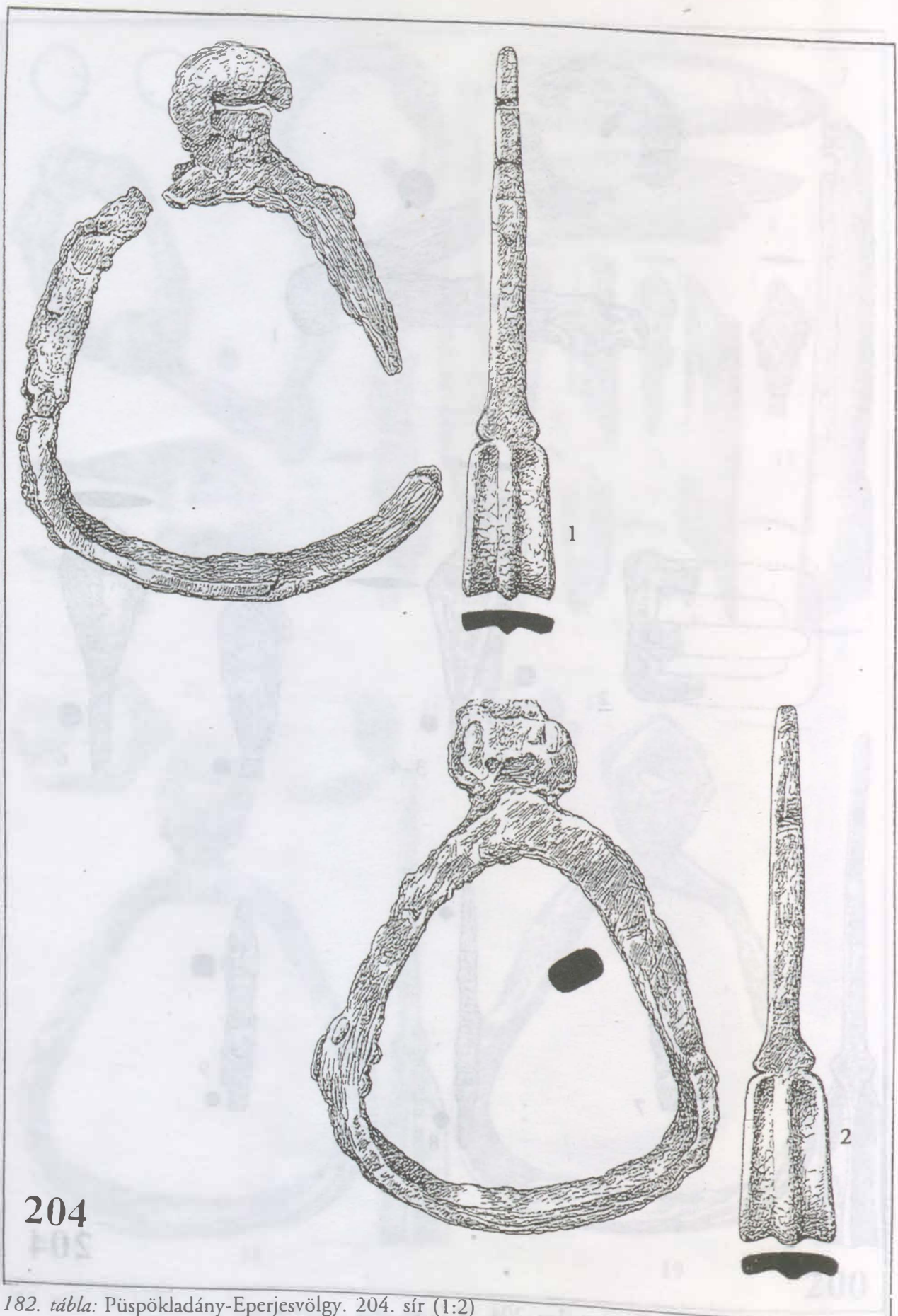

204

182. tábla: Püspökladány-Eperjesvölgy. 204. sír (1:2)

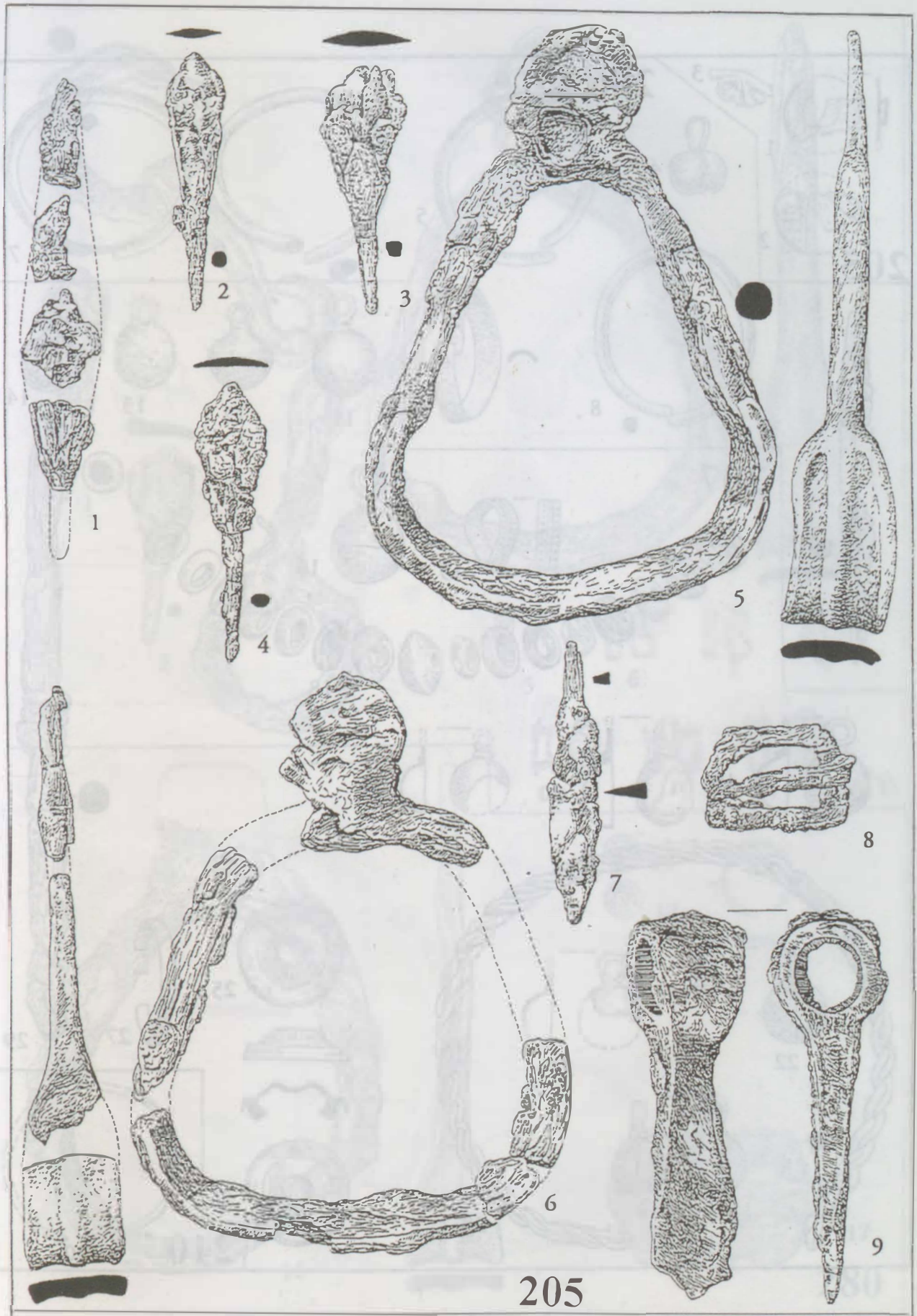

183. tábla: Püspökladány-Eperjesvölgy. 205. sár (1:2)

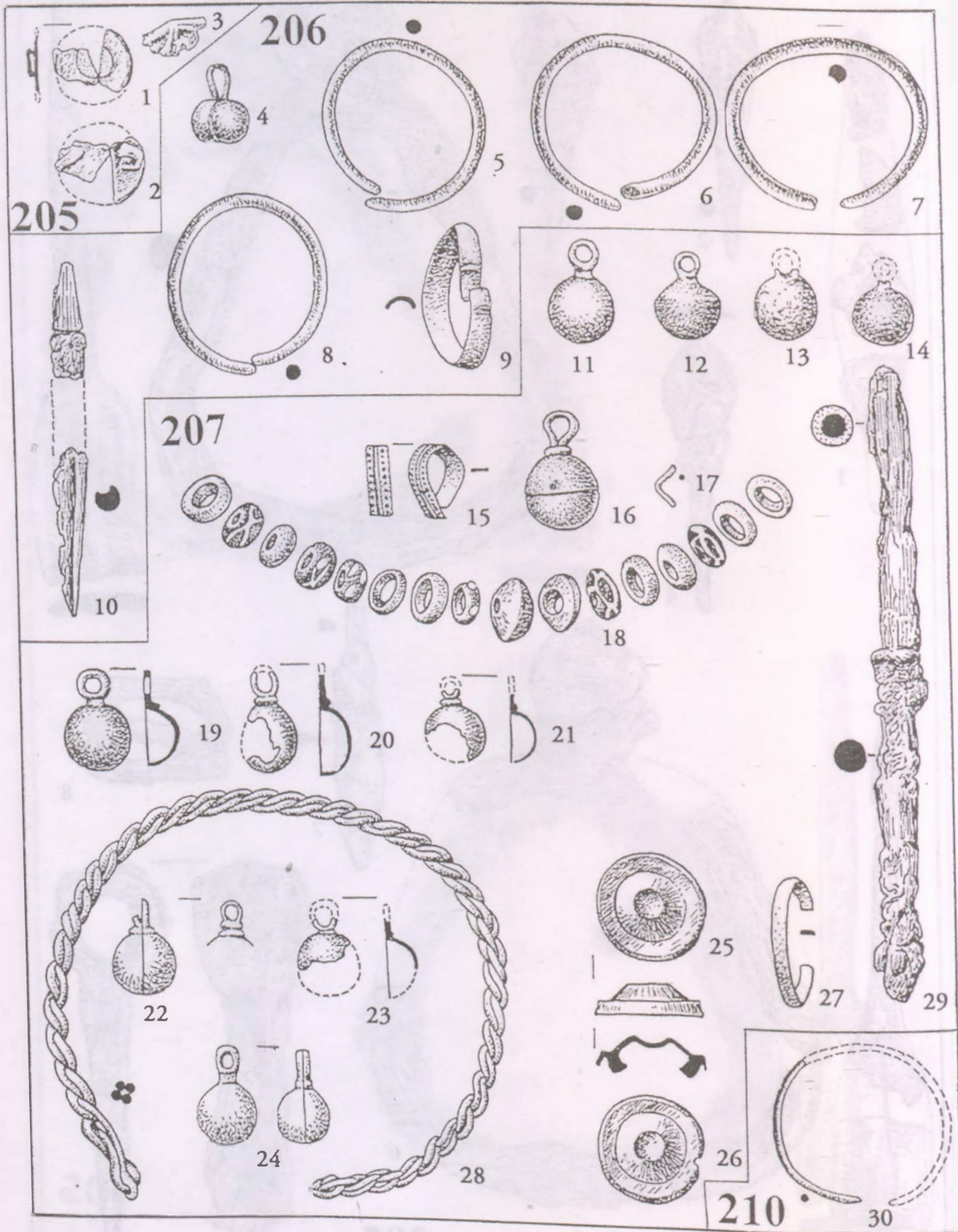

184. tábla: Püspökladány-Eperjesvölgy. 205–207., 210. sír (1:1)

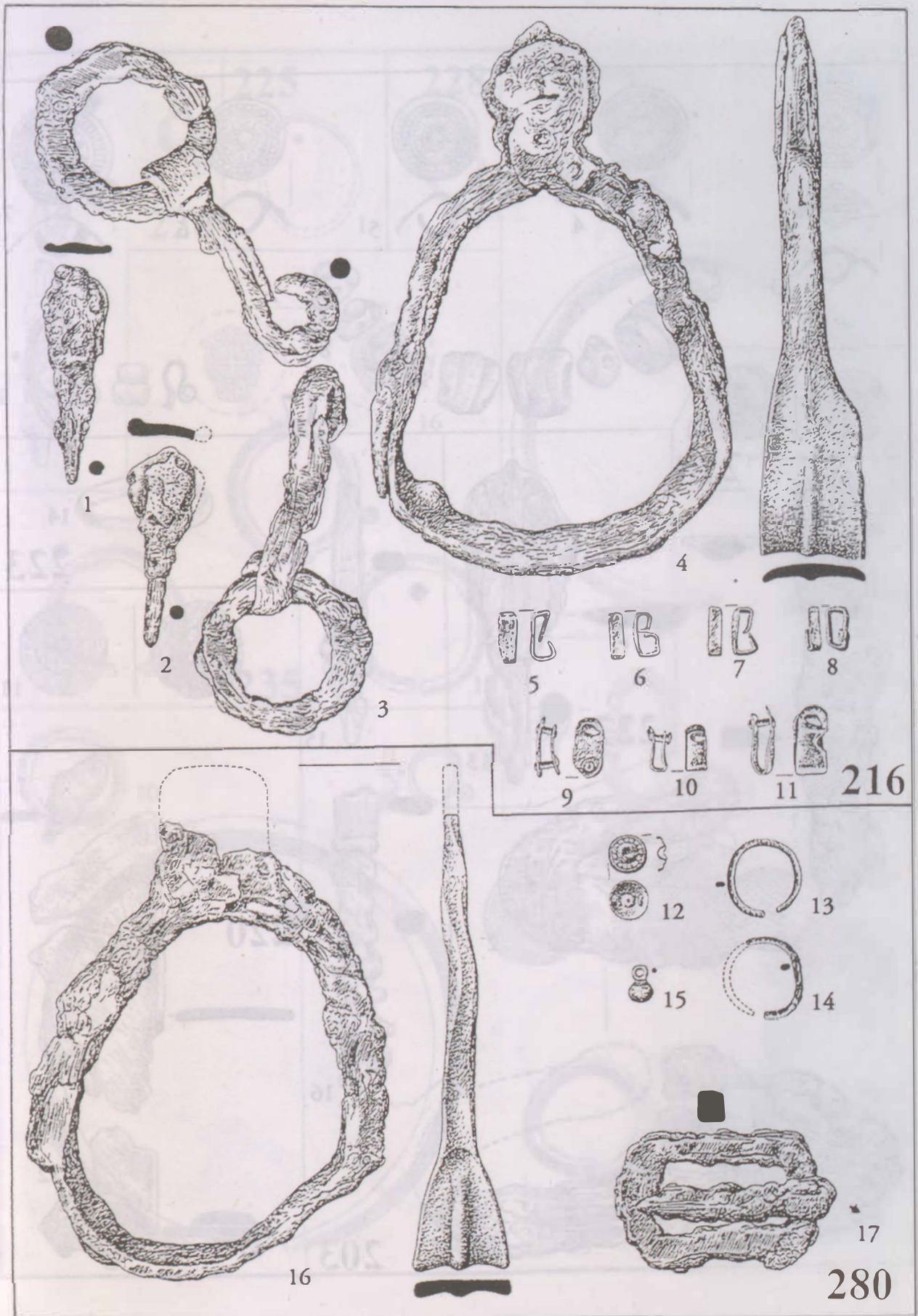

185. tábla: Püspökladány-Eperjesvölgy. 216., 280. sír (1:2)

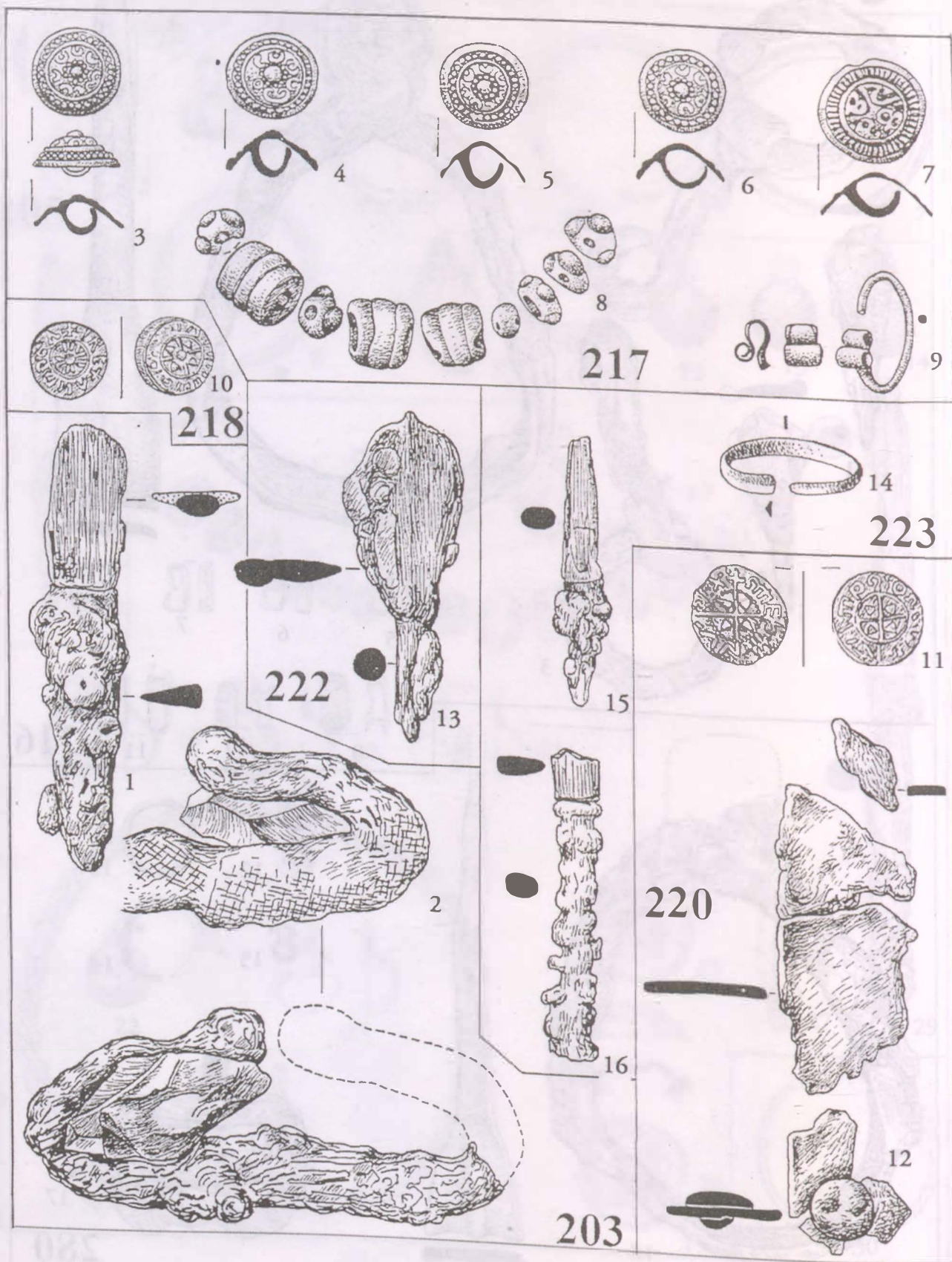

186. tábla: Püspökladány-Eperjesvölgy. 203., 217–218., 220., 222–223. sír (1:1)

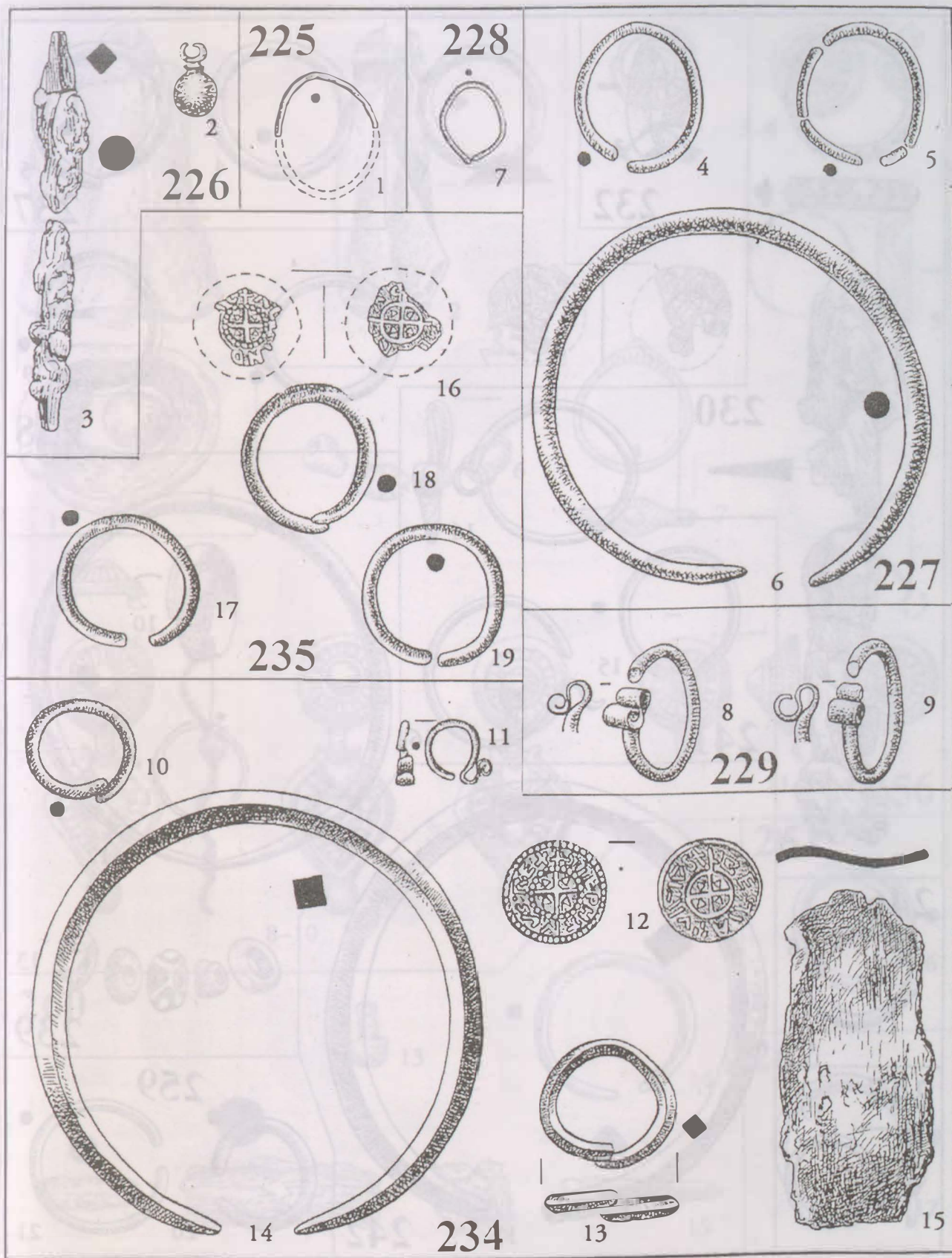

187. tábla: Püspökladány-Eperjesvölgy, 225–229., 234–235. sír (1:1)

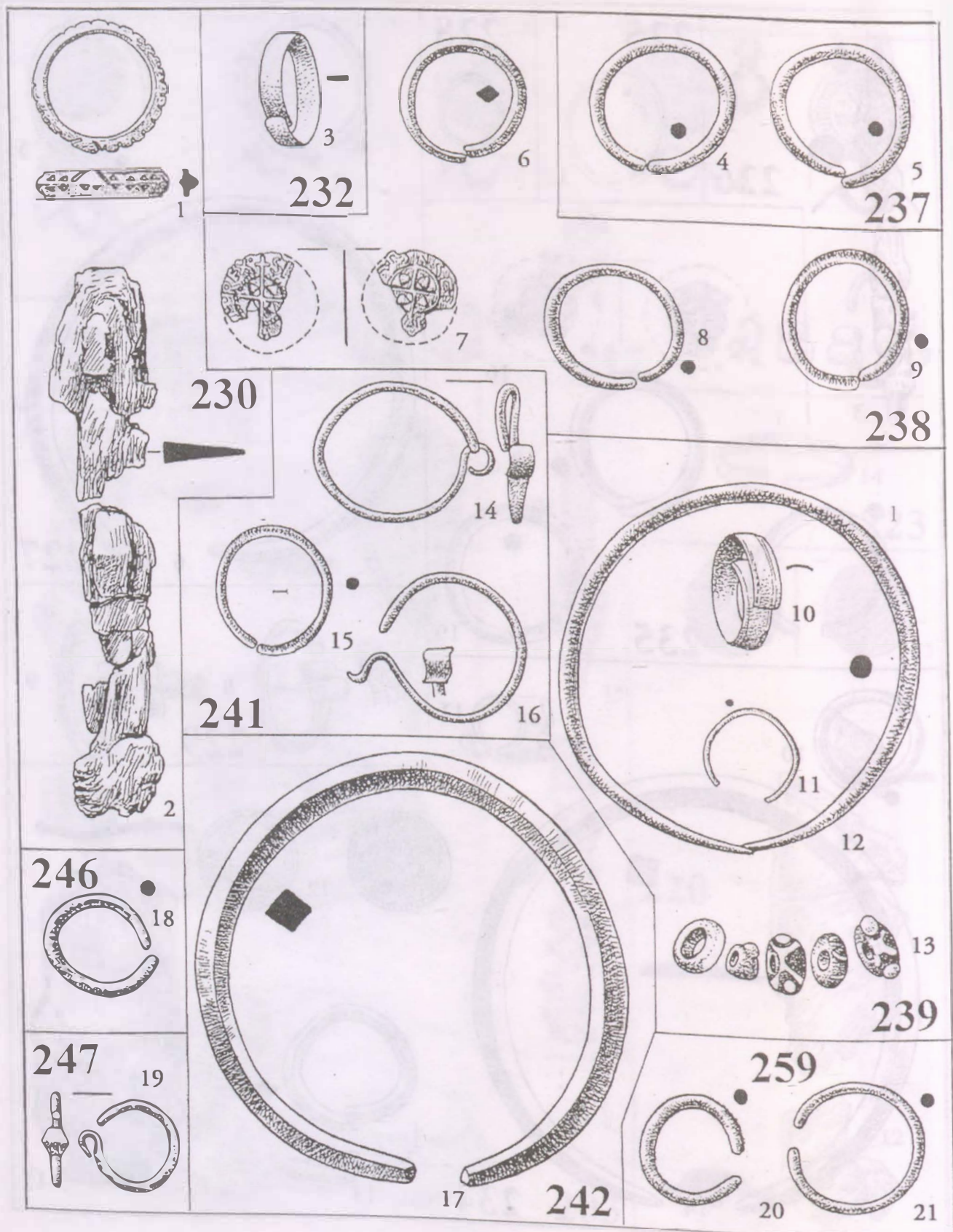

188. tábla: Püspökladány-Eperjesvölgy. 230., 232., 237–239., 241–242., 246–247., 259. sír (1:1)

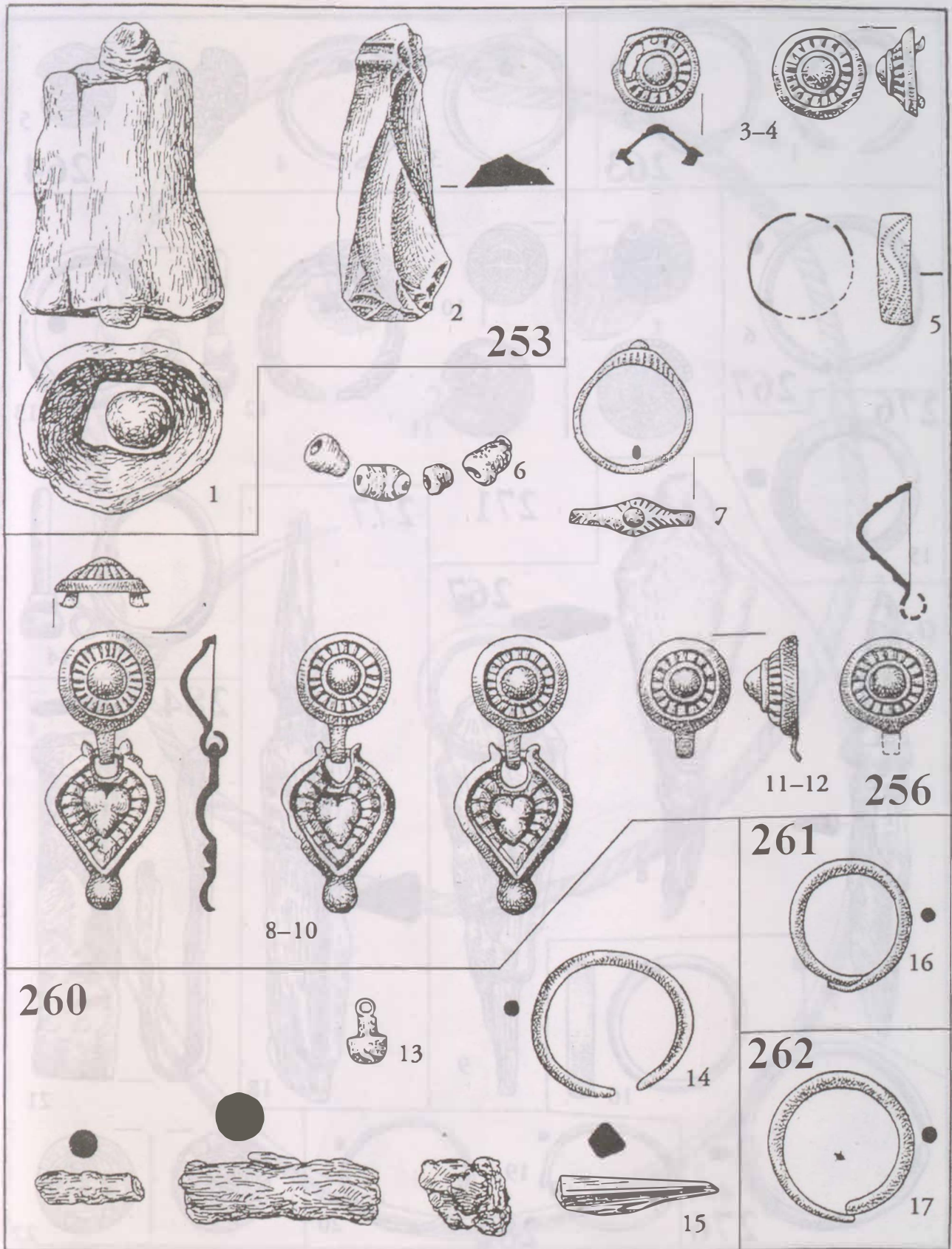

189. tábla: Püspökladány-Eperjesvölgy. 253., 256., 260–262. sír (1:1)

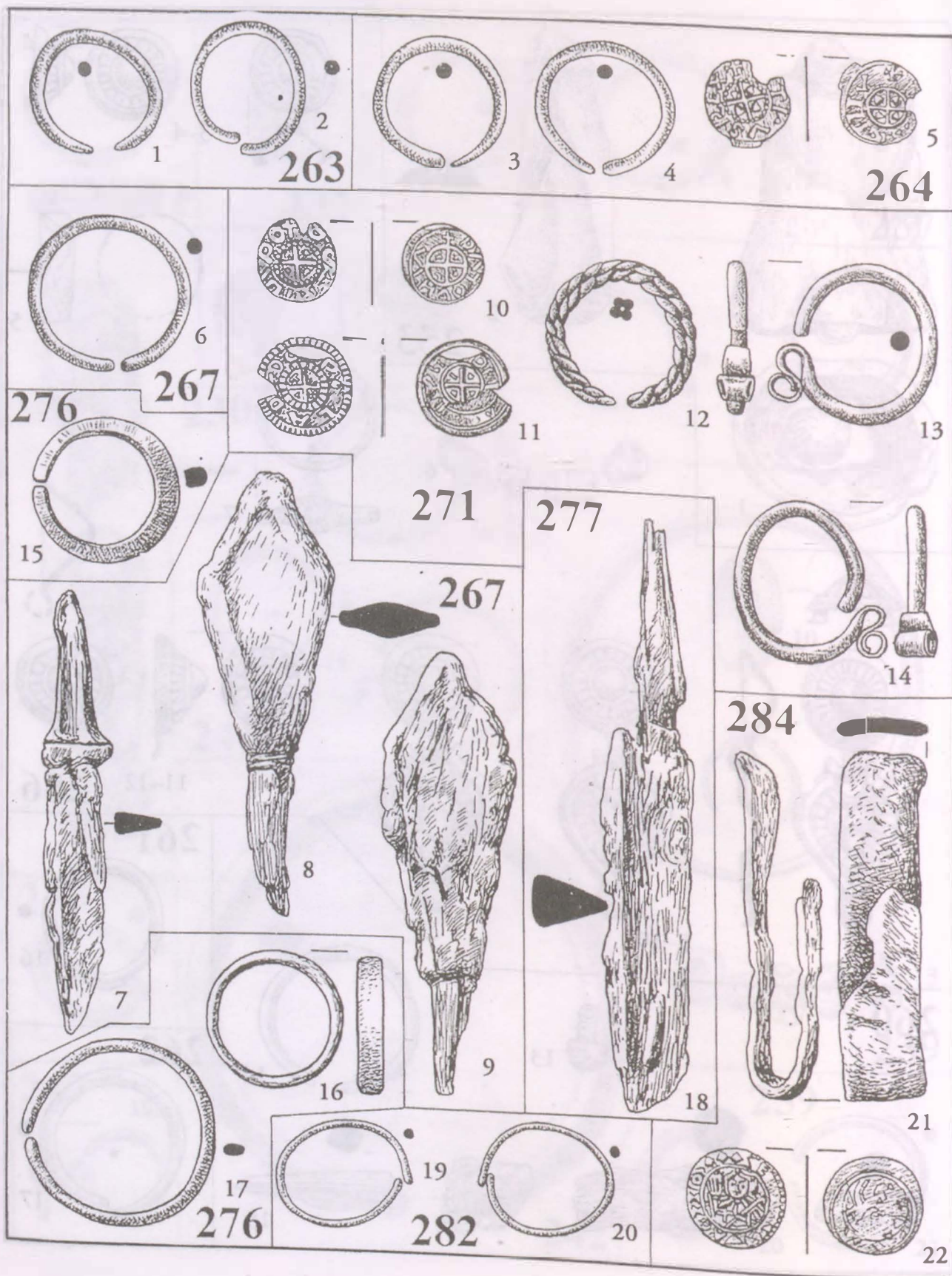

190. tábla: Püspökladány-Eperjesvölgy. 263–264., 267., 271., 276–277., 282., 284. sír

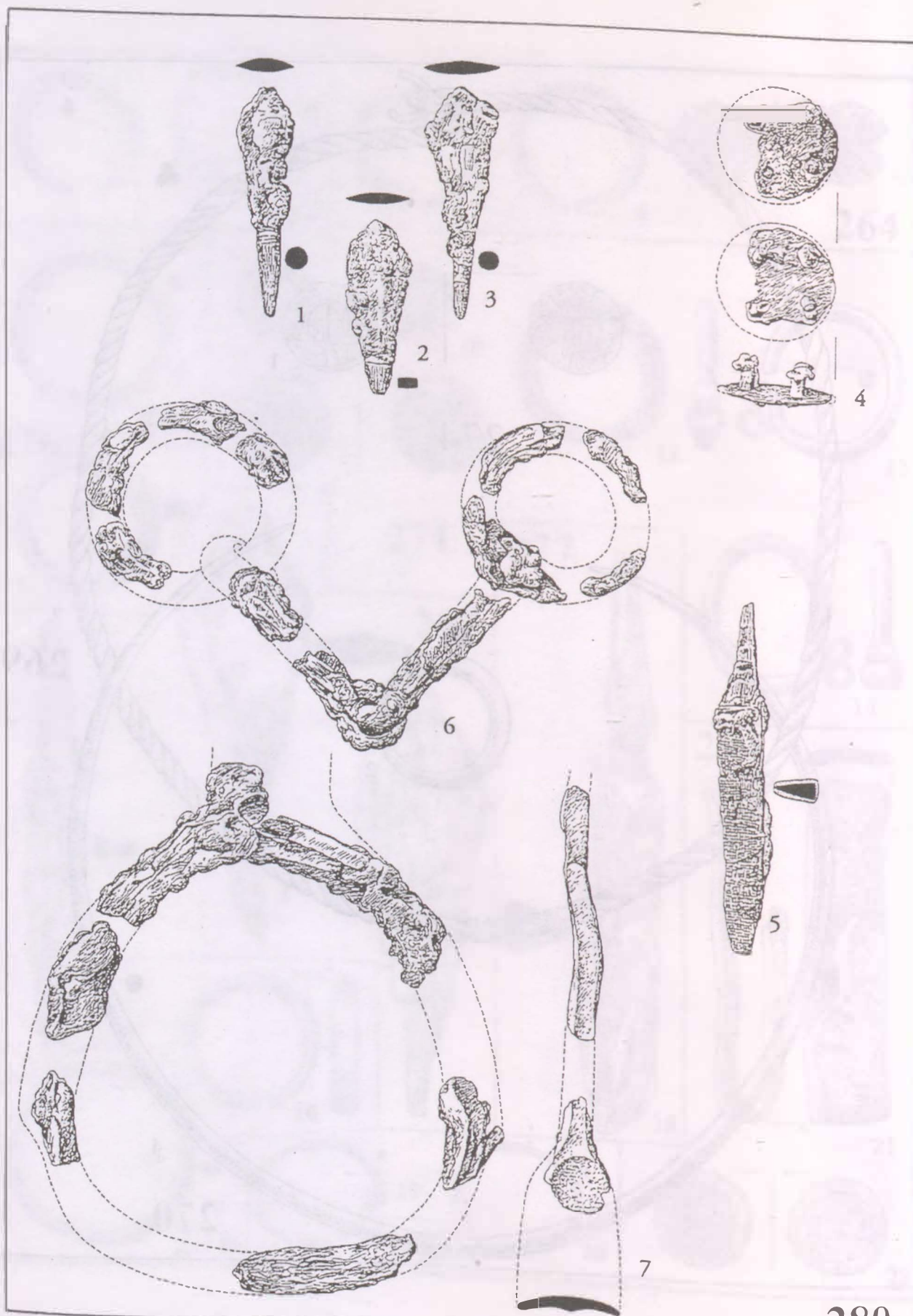

192. tábla: Püspökladány-Eperjesvölgy. 280. sír (1:2)

280

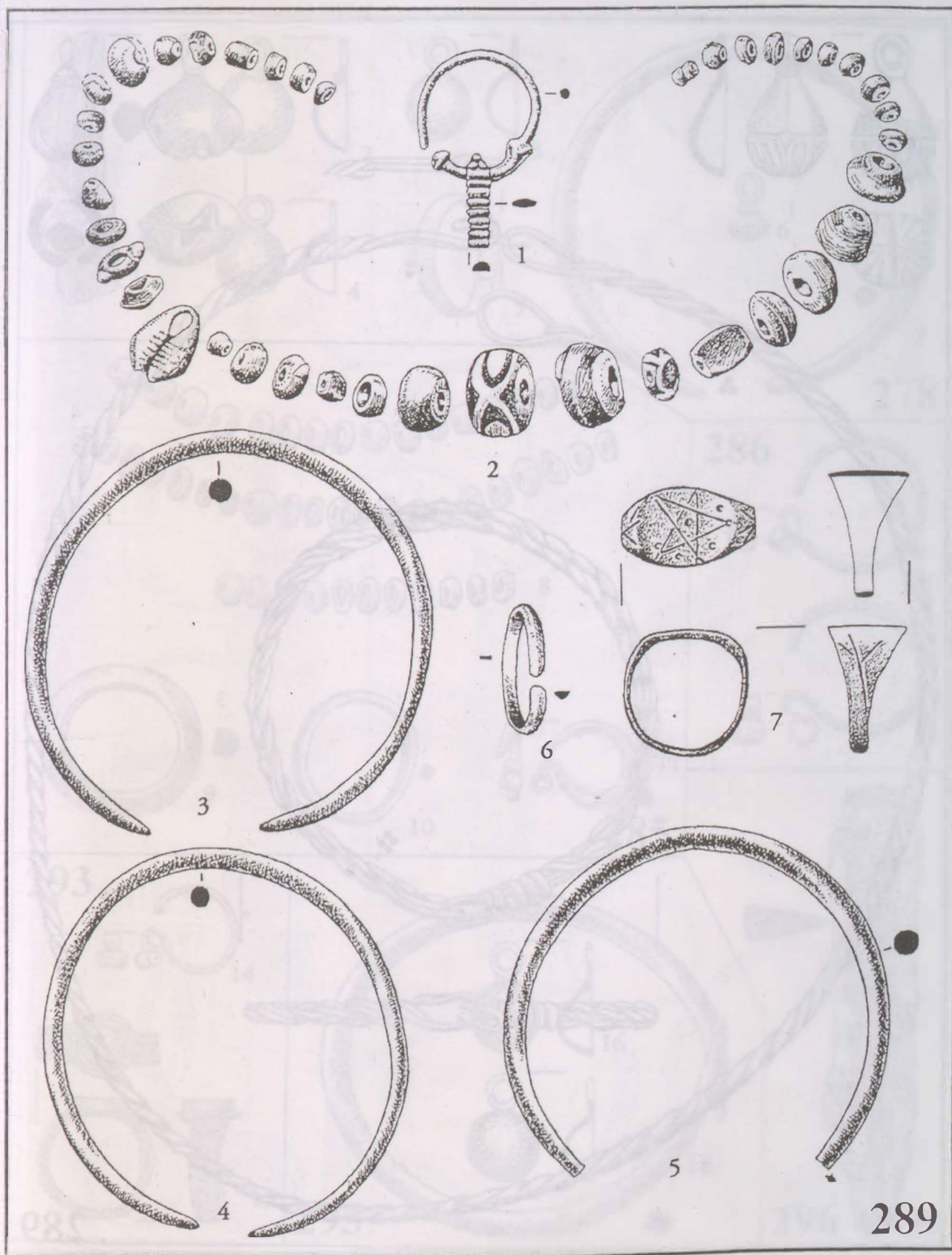

289

193. tábla: Püspökladány-Eperjesvölgy. 289. sír (1:1)

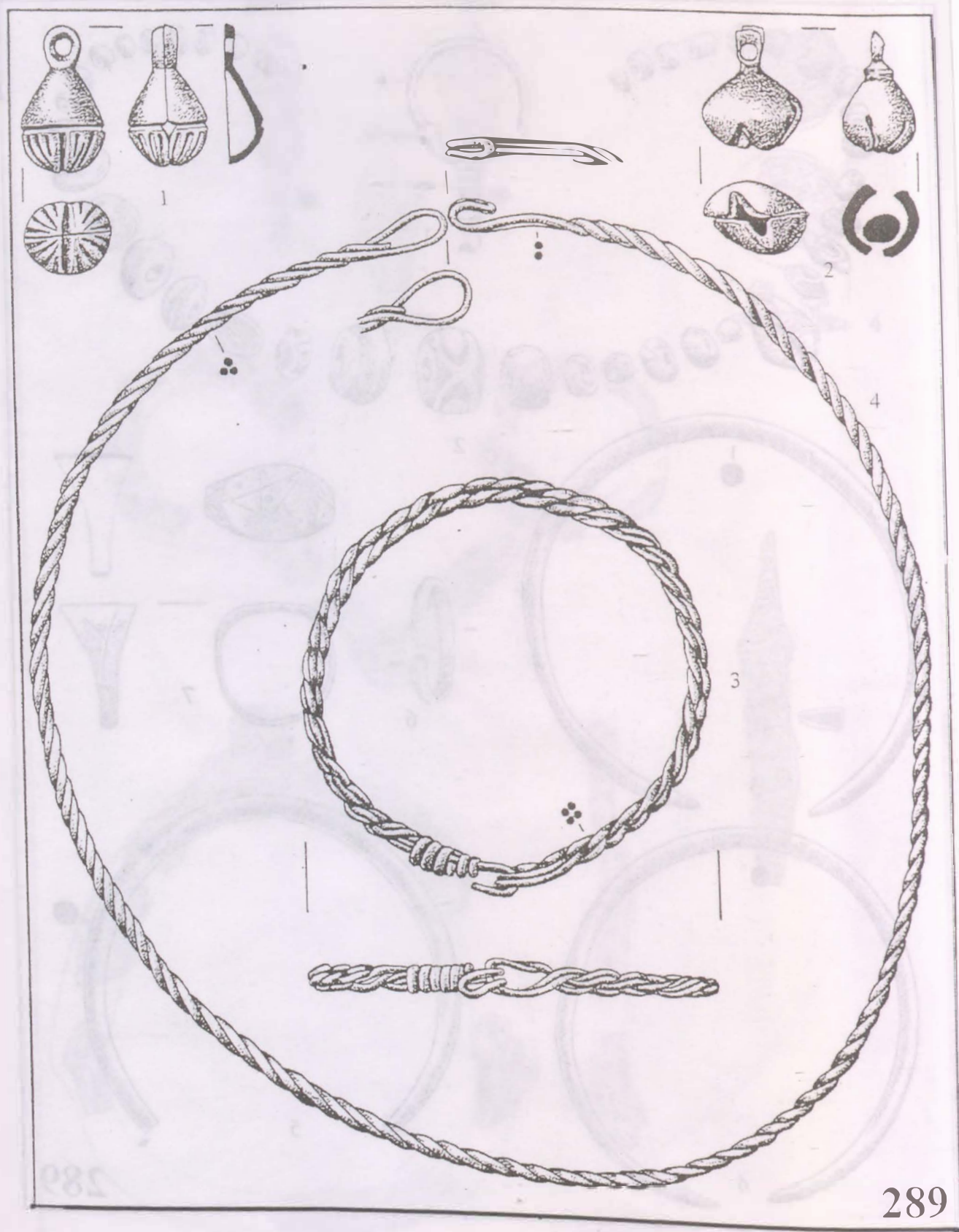

194. tábla: Püspökladány-Eperjesvölgy. 289. sír (1:1)

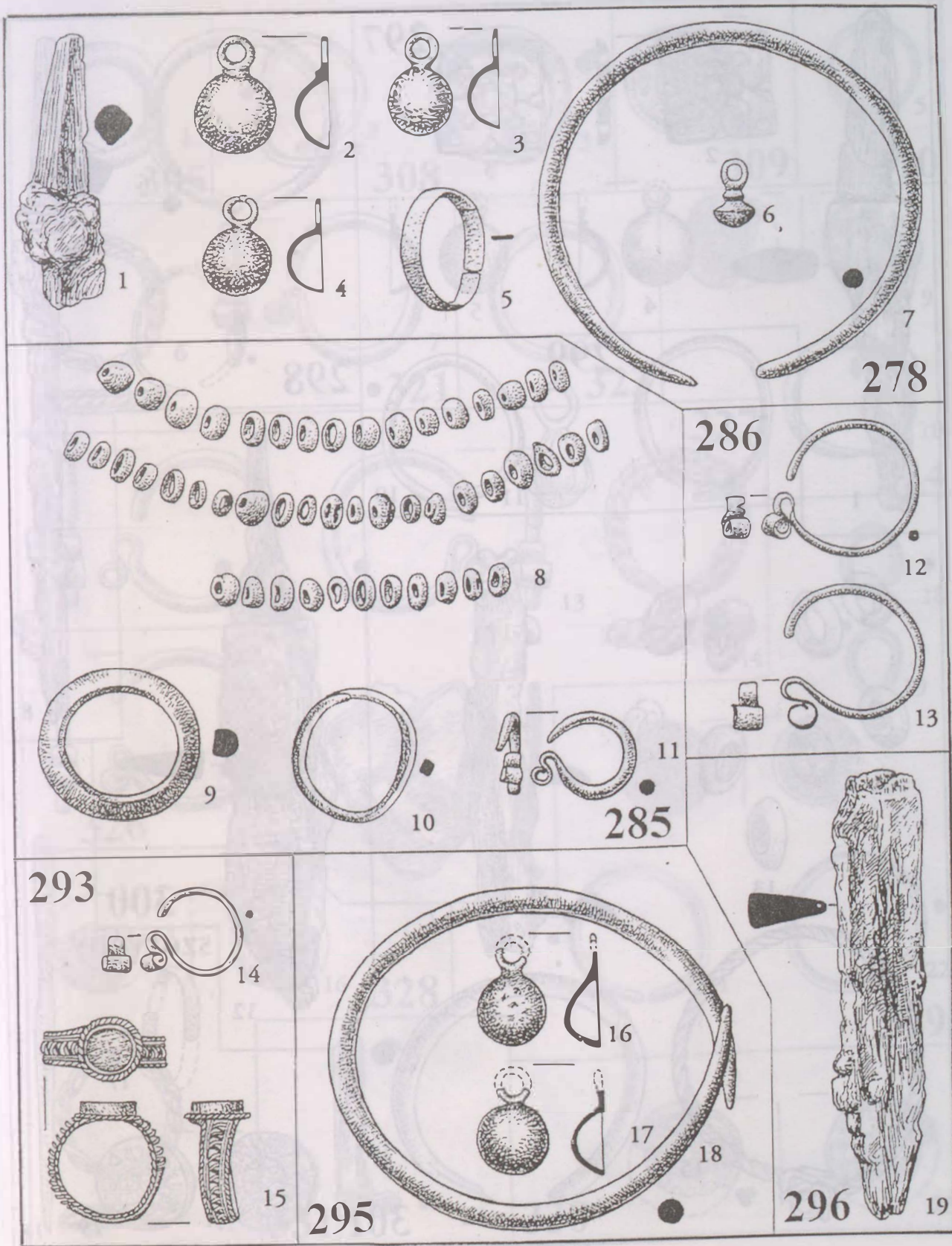

195. tábla: Püspökladány-Eperjesvölgy. 278., 285–286., 293., 295–296. sír (1:1)

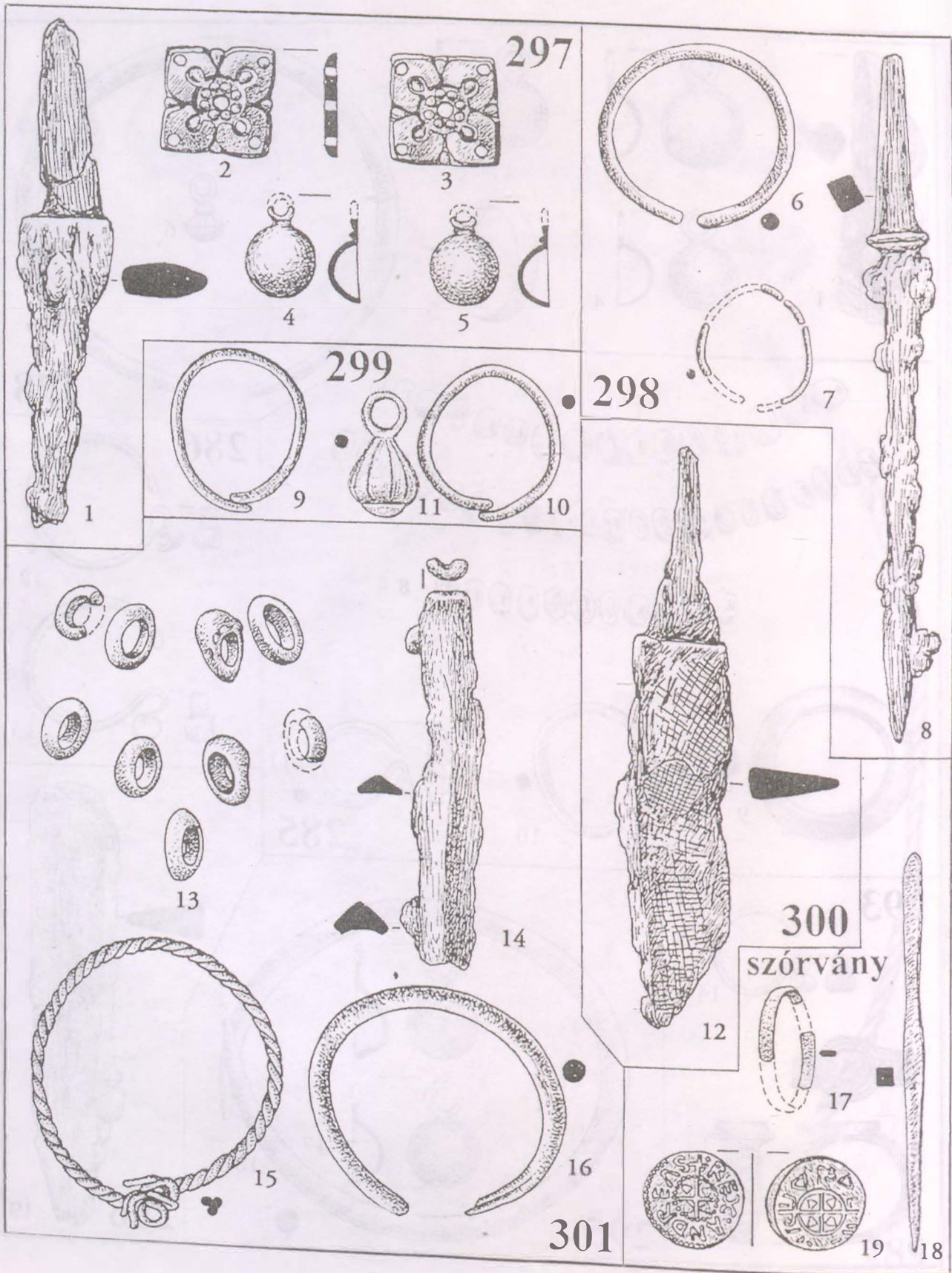

196. tábla: Püspökladány-Eperjesvölgy. 297-301., szórvány (1:1)

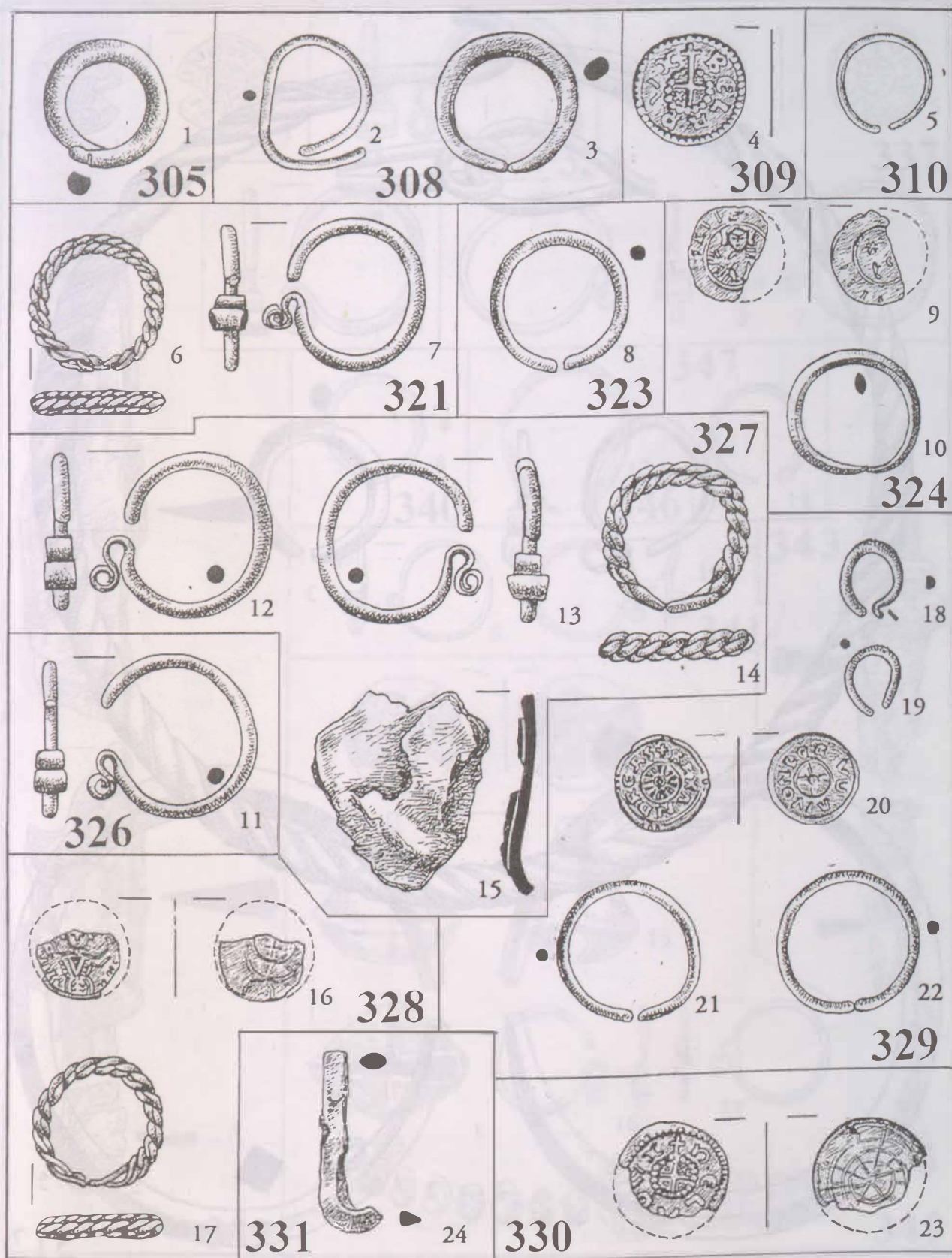

197. tábla: Püspökladány-Eperjesvölgy. 305., 308–310., 321., 323–324., 326–331. sír (1:1)

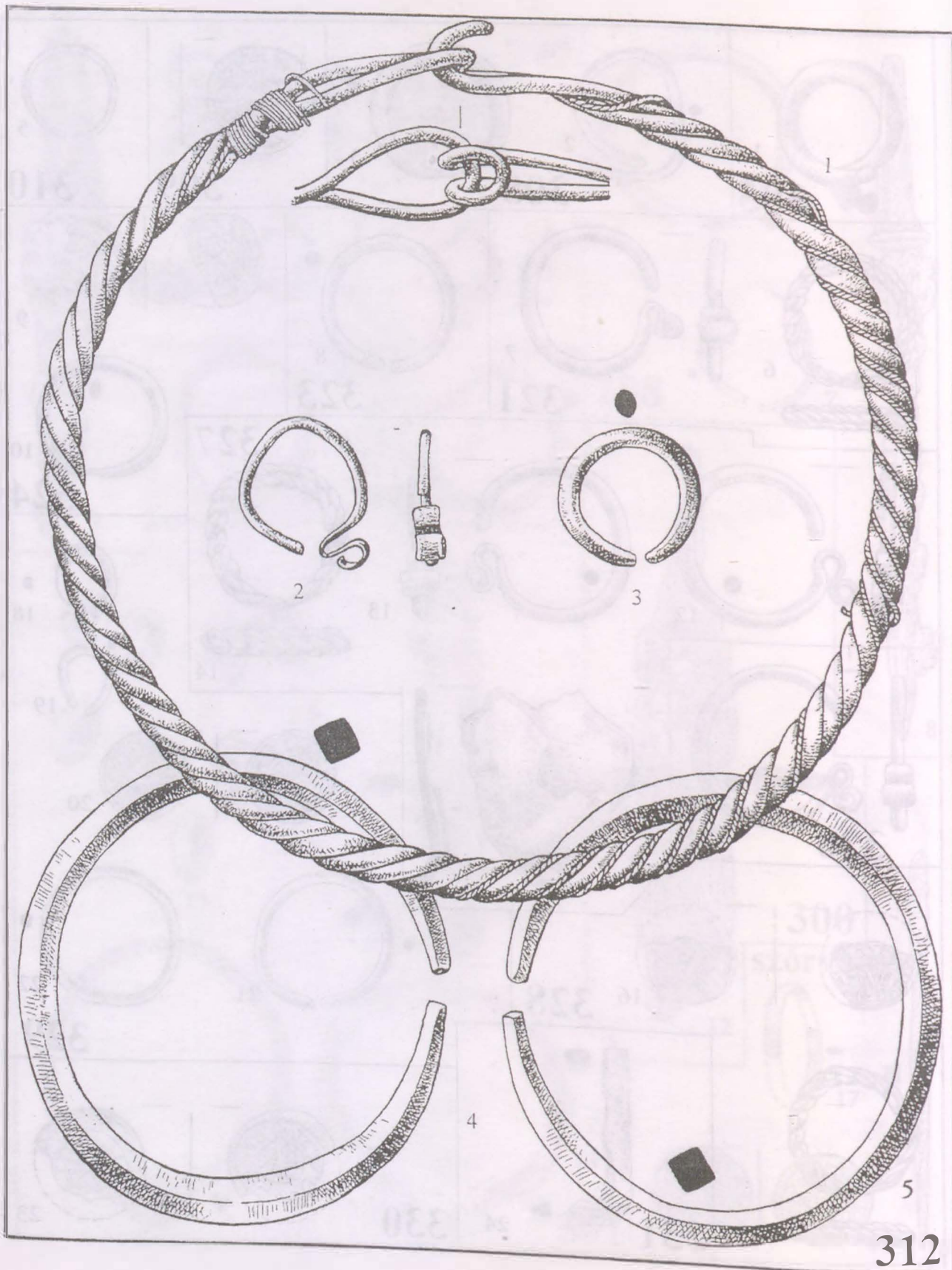

198. tábla: Püspökladány-Eperjesvölgy. 312. sír (1:1)

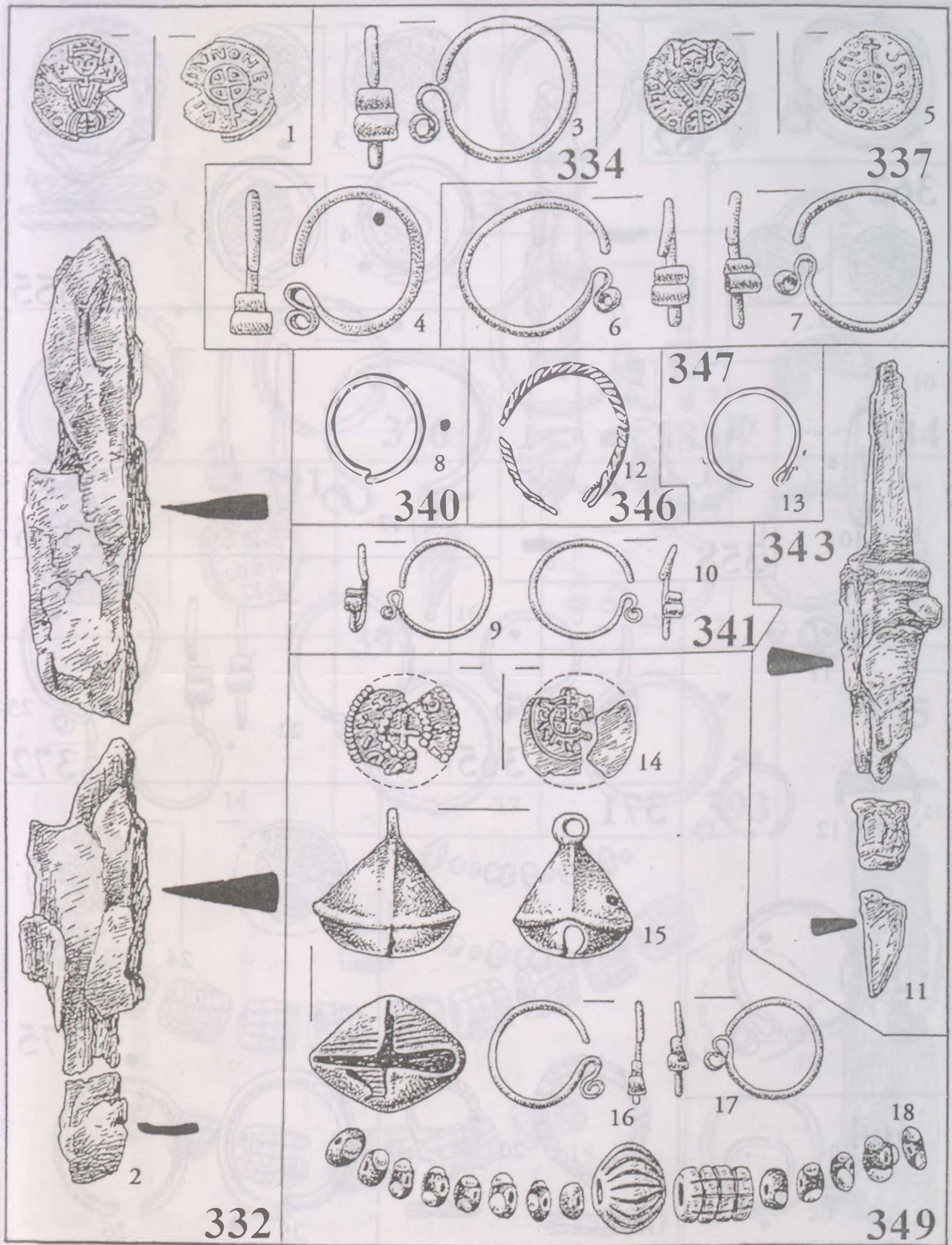

199. tábla: Püspökladány-Eperjesvölgy. 332., 334., 337., 340–341., 343., 346–347., 349. sír (1:1)

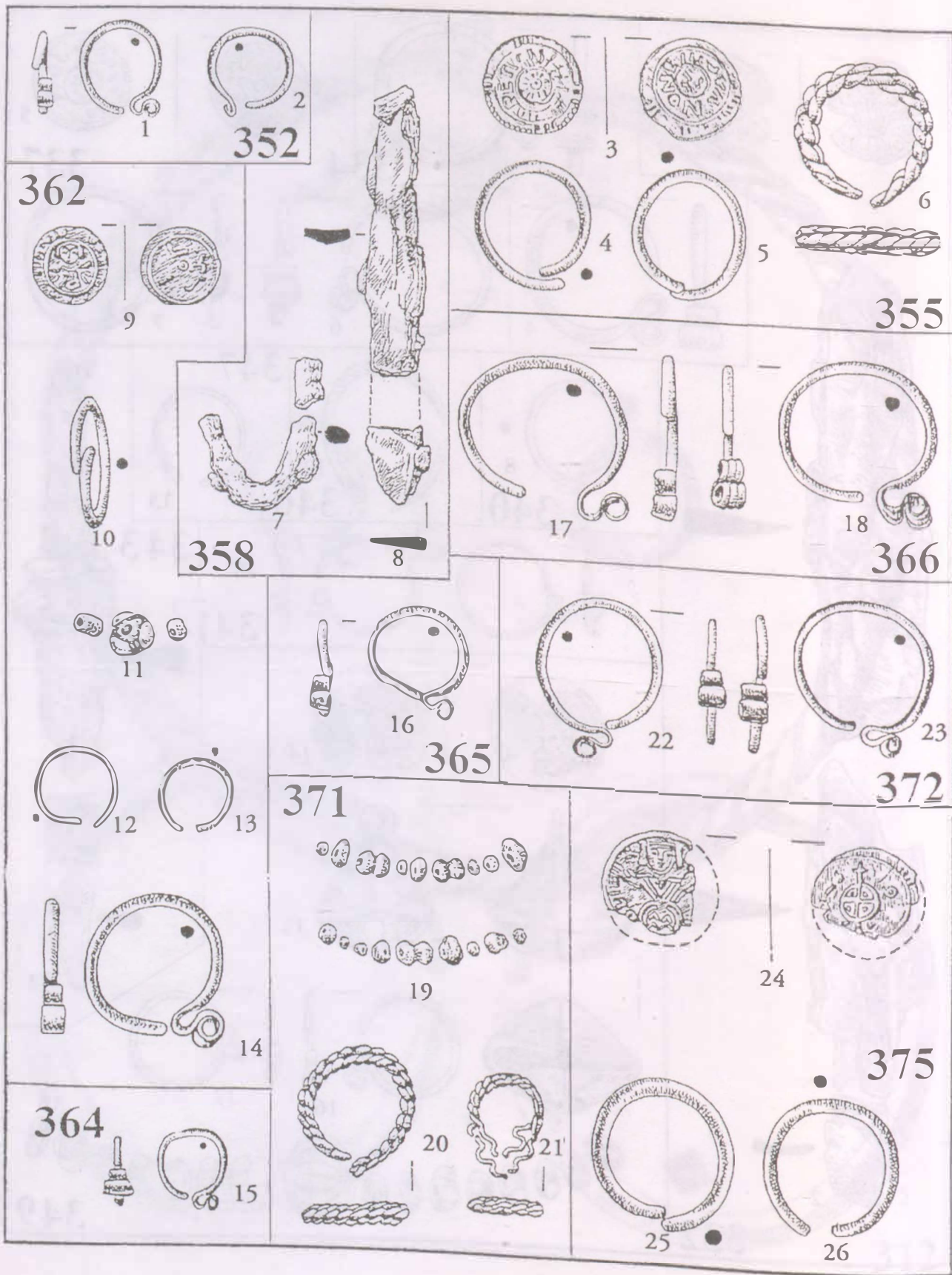

200. tábla: Püspökladány-Eperjesvölgy. 352., 355., 358., 362., 364–366., 371–372., 375. sír (1:1)

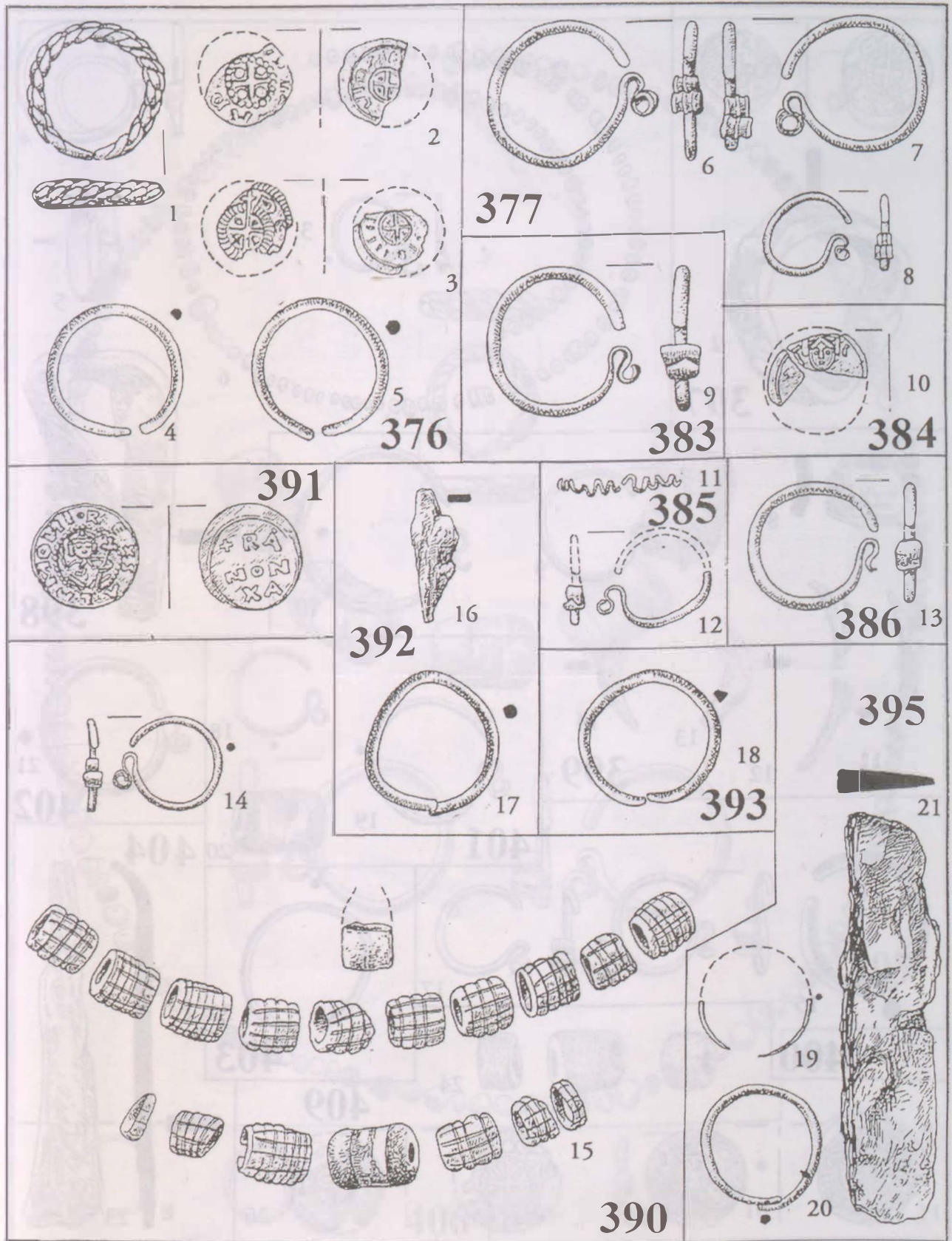

201. tábla: Püspökladány-Eperjesvölgy. 376–377., 383–386., 390–393., 395. sír (1:1)

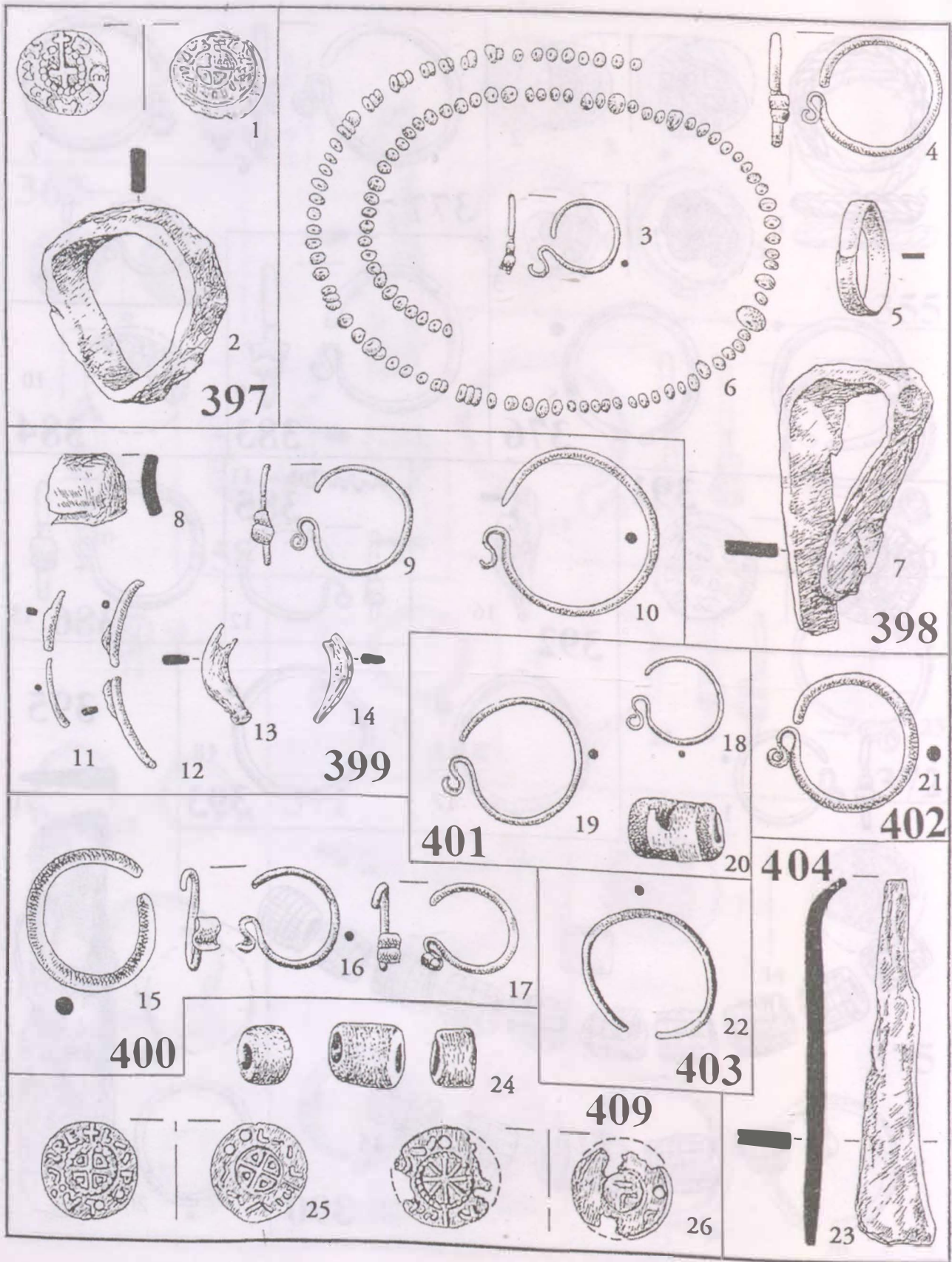

202. tábla: Püspökladány-Eperjesvölgy. 397-404., 409. sír (1:1)

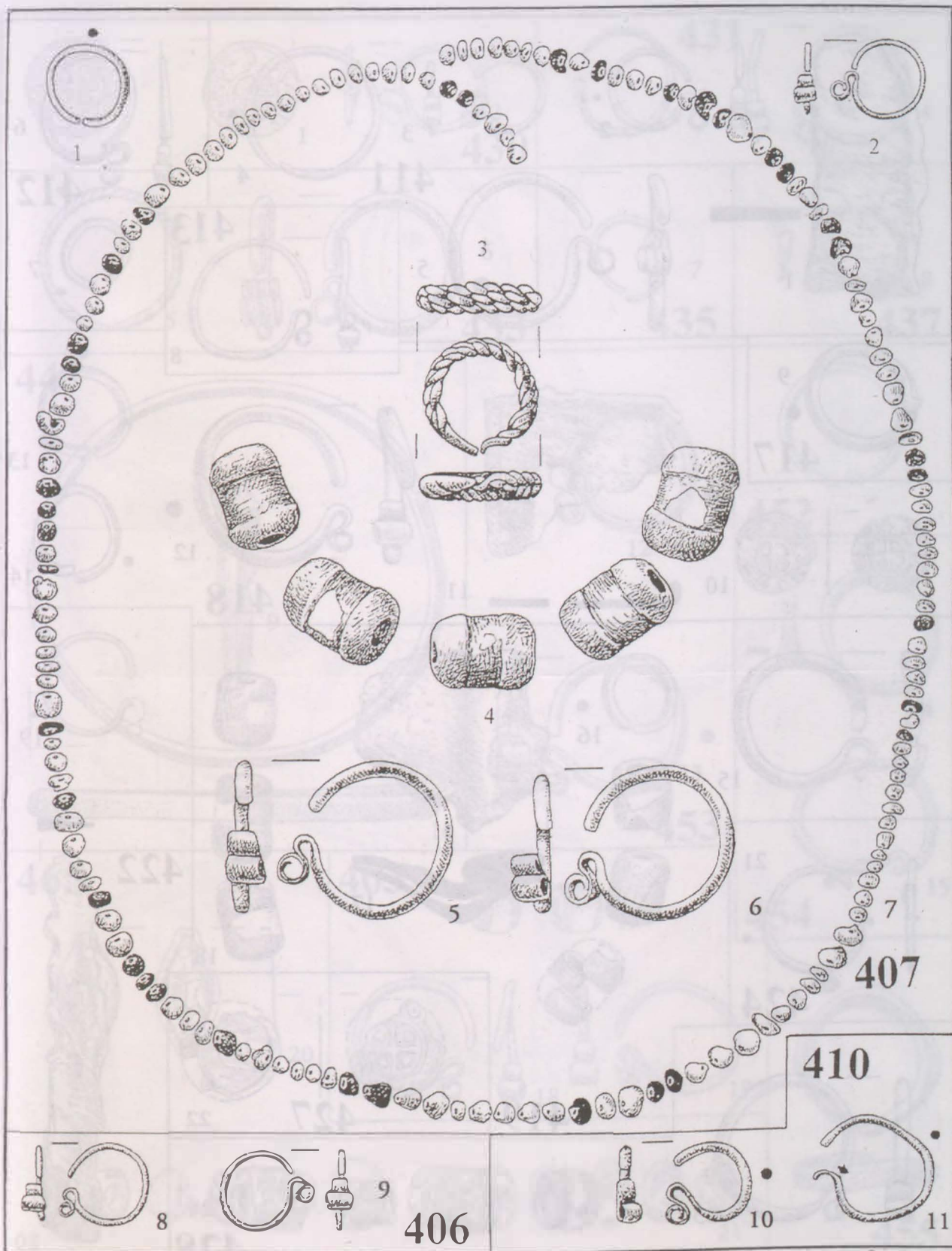

203. tábla: Püspökladány-Eperjesvölgy. 406–407., 410. sír (1:1)

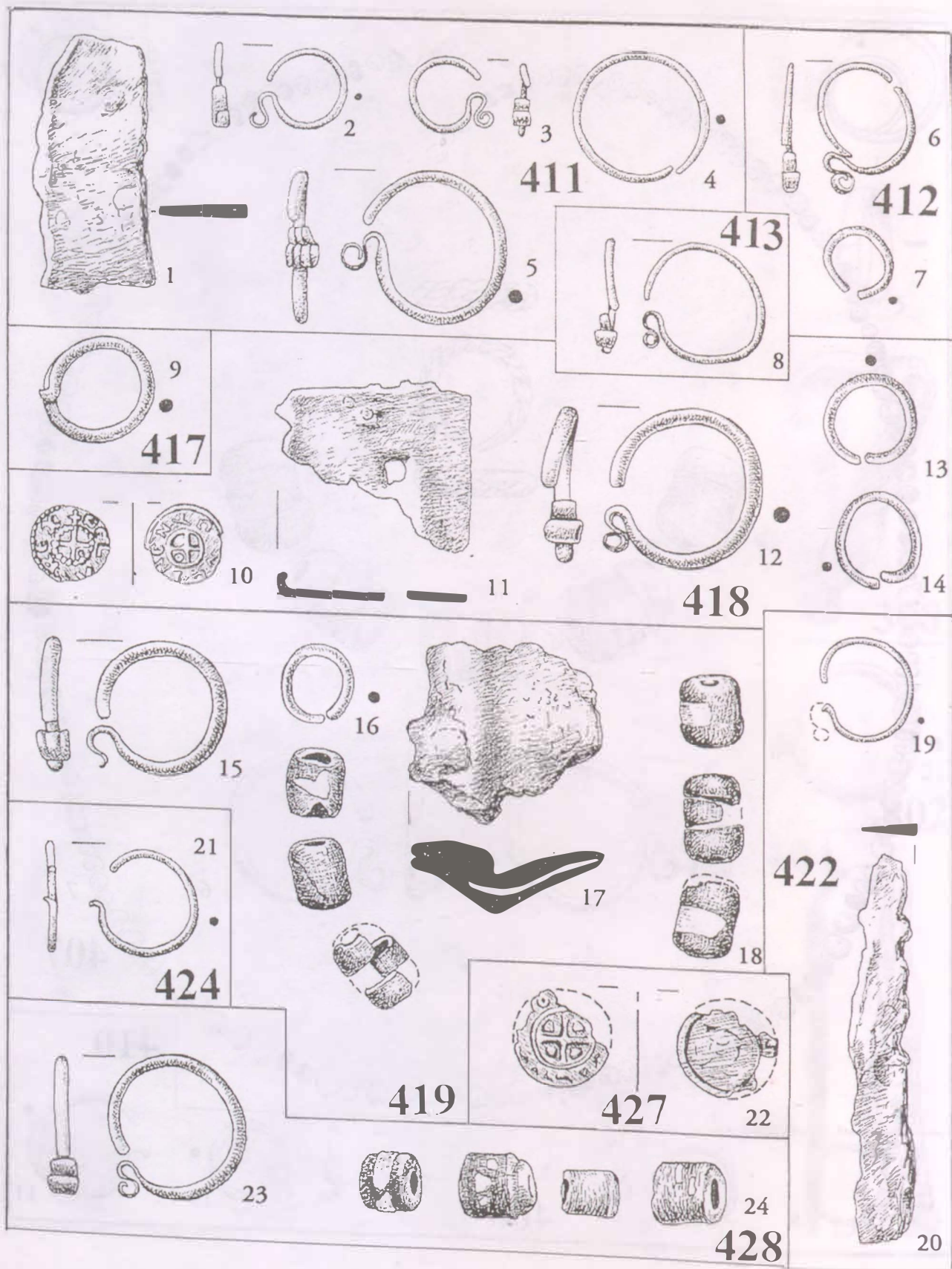

204. tábla: Püspökladány-Eperjesvölgy. 411-413., 417-419., 422., 424., 427-428. sír (1:1)

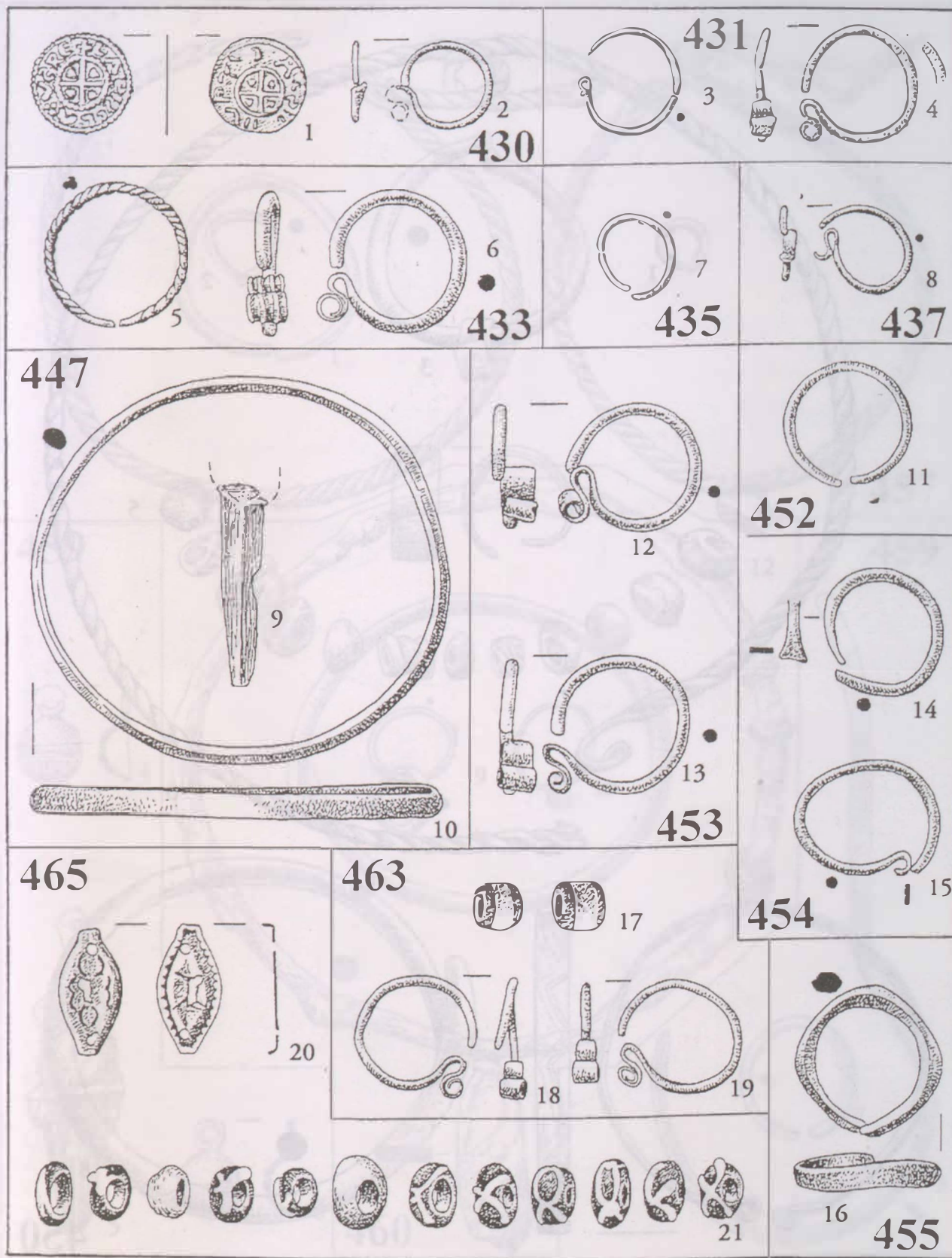

205. tábla: Püspökladány-Eperjesvölgy. 430–431., 433., 435., 437., 447., 452–455., 463., 465. sír (1:1)

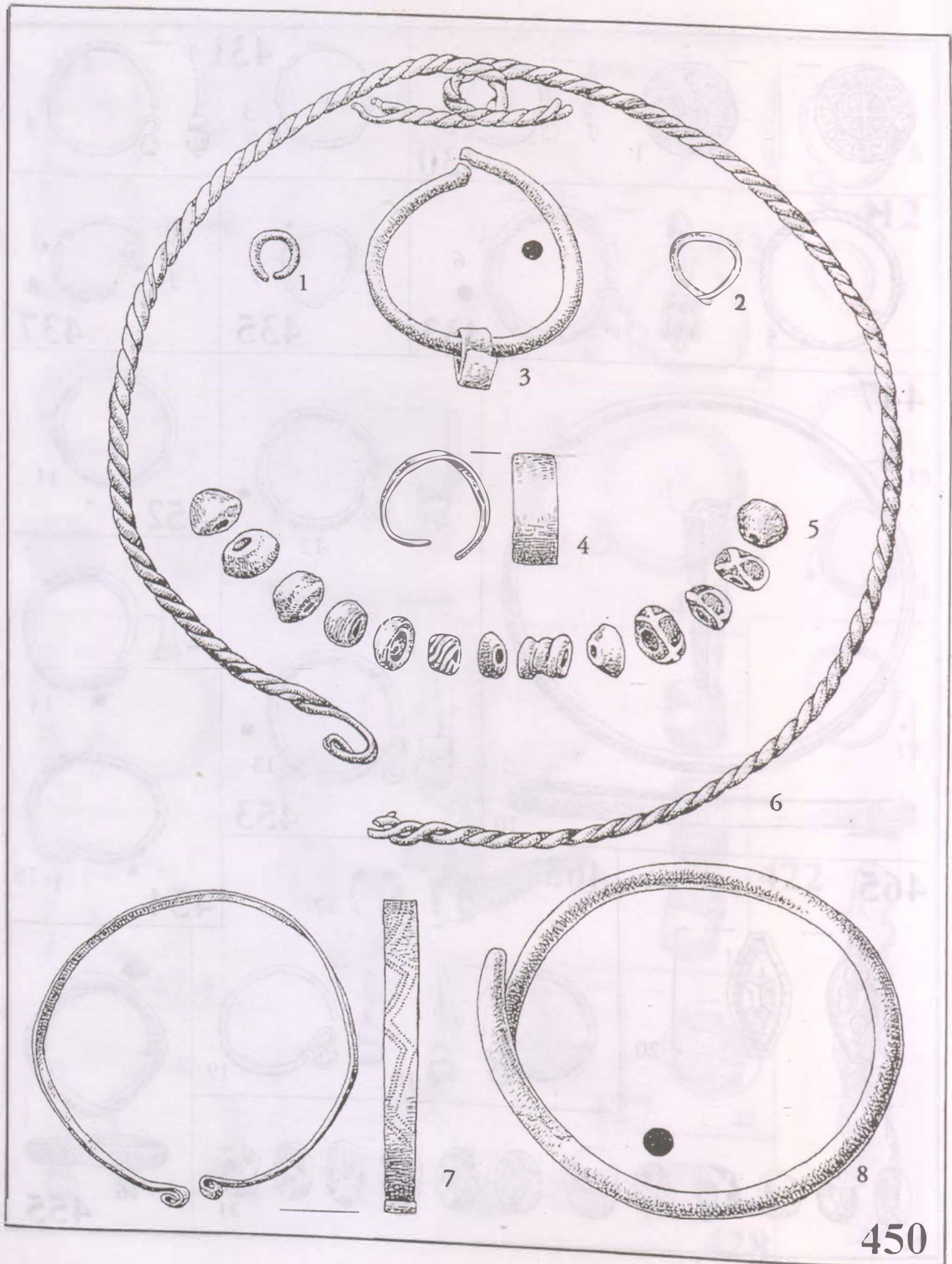

450

206. tábla: Püspökladány-Eperjesvölgy. 450. sír (1:1)

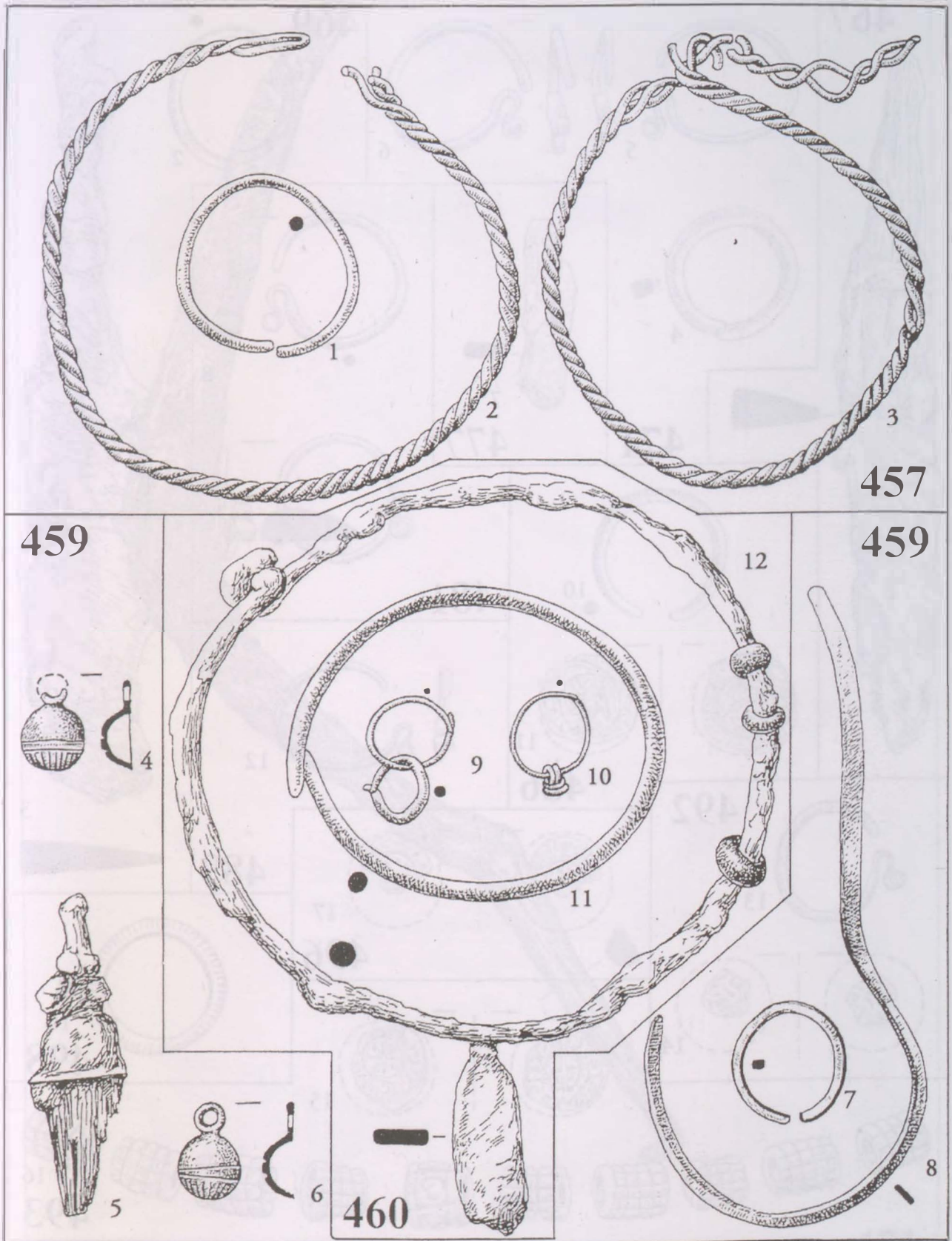

207. tábla: Püspökladány-Eperjesvölgy. 457., 459–460. sír (1:1)

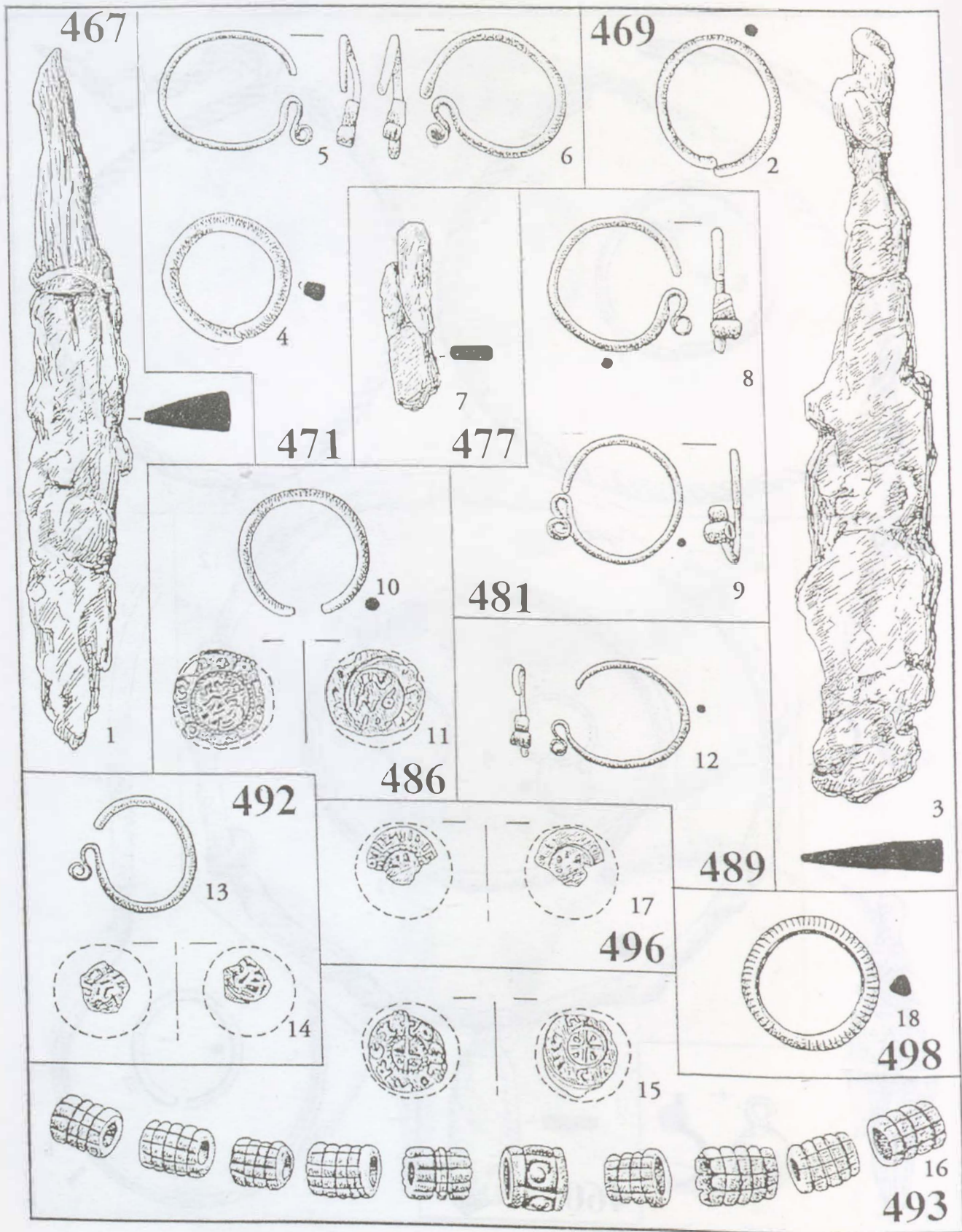

208. tábla: Püspökladány-Eperjesvölgy. 467., 469., 471., 477., 481., 486., 489., 492-493., 496., 498. sír (1:1)

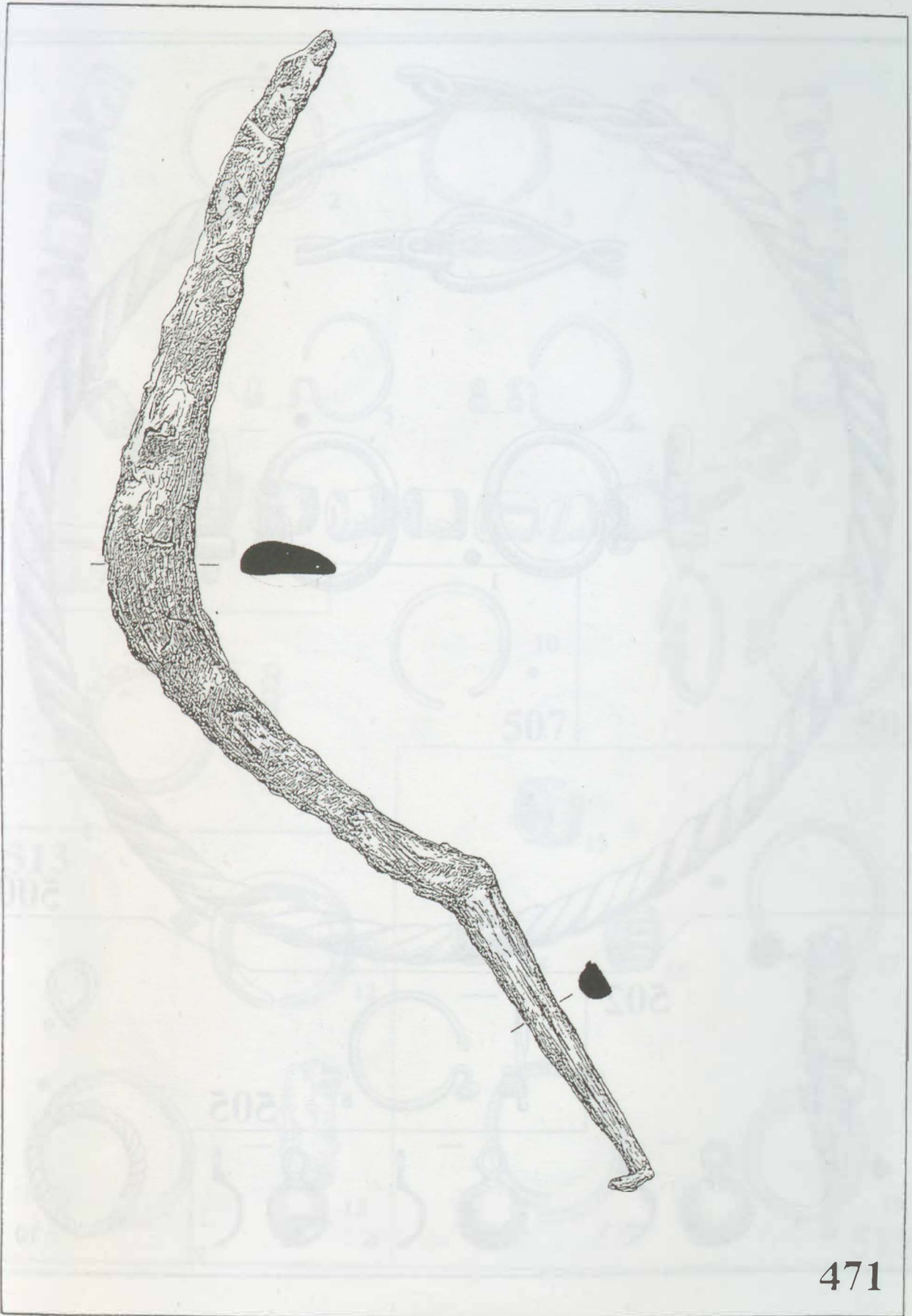

209. tábla: Püspökladány-Eperjesvölgy. 471 sír (1:2)

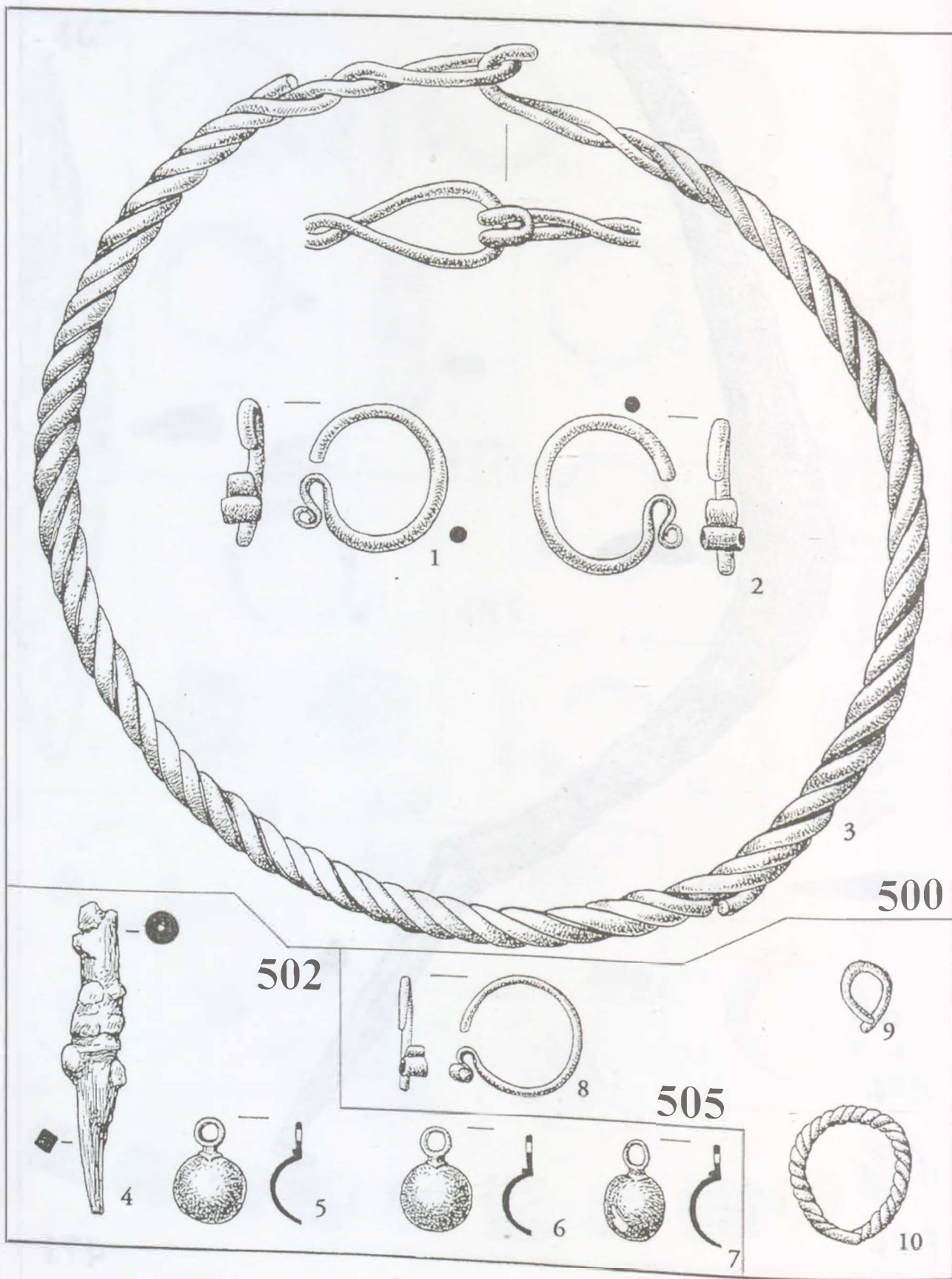

210. tábla: Püspökladány-Eperjesvölgy. 500., 502., 505. sír (1:1)

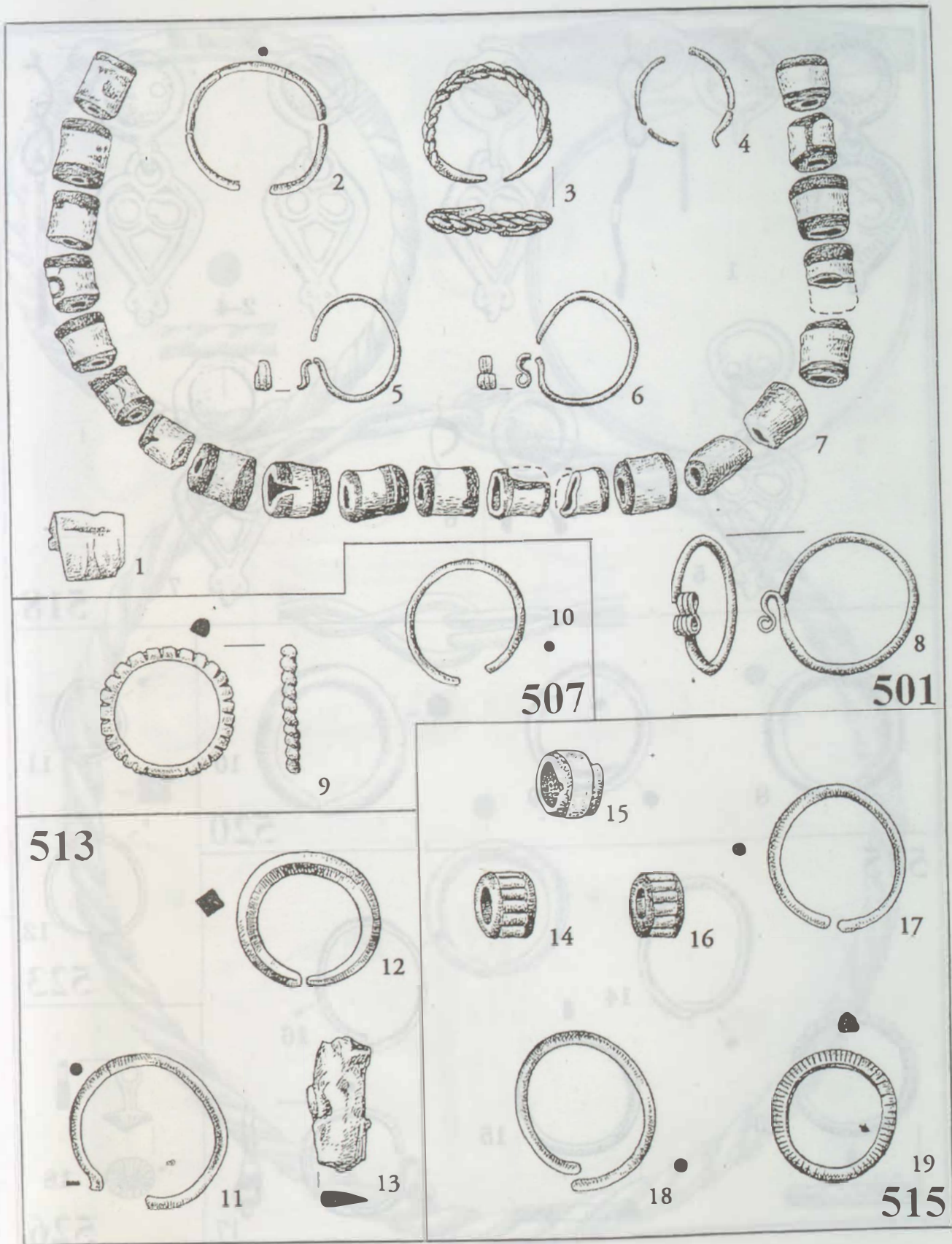

211. tábla: Püspökladány-Eperjesvölgy. 501., 507., 513., 515. sír (1:1)

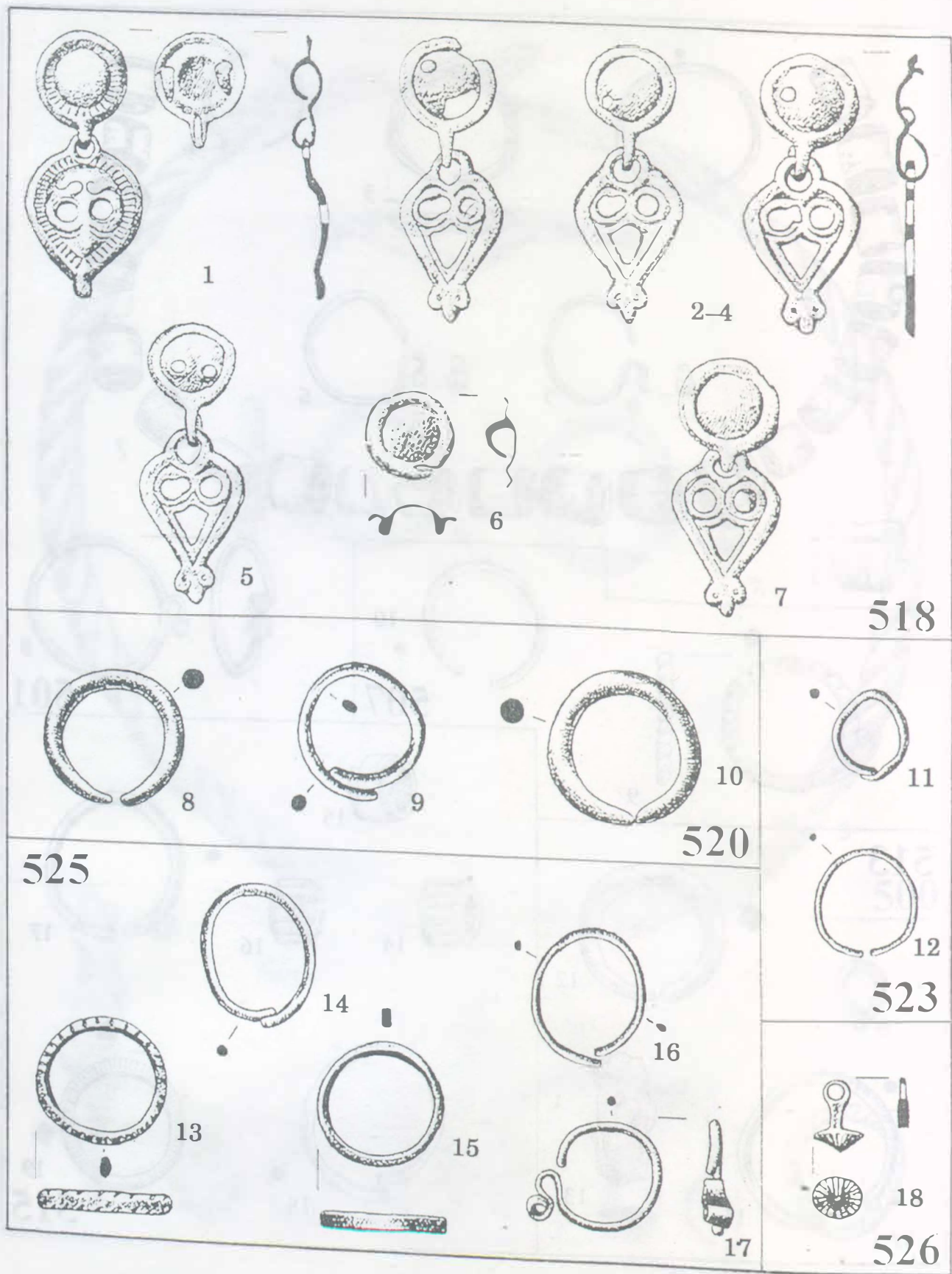

212. tábla: Püspökladány-Eperjesvölgy. 518., 520., 523., 525-526. sír (1:1)

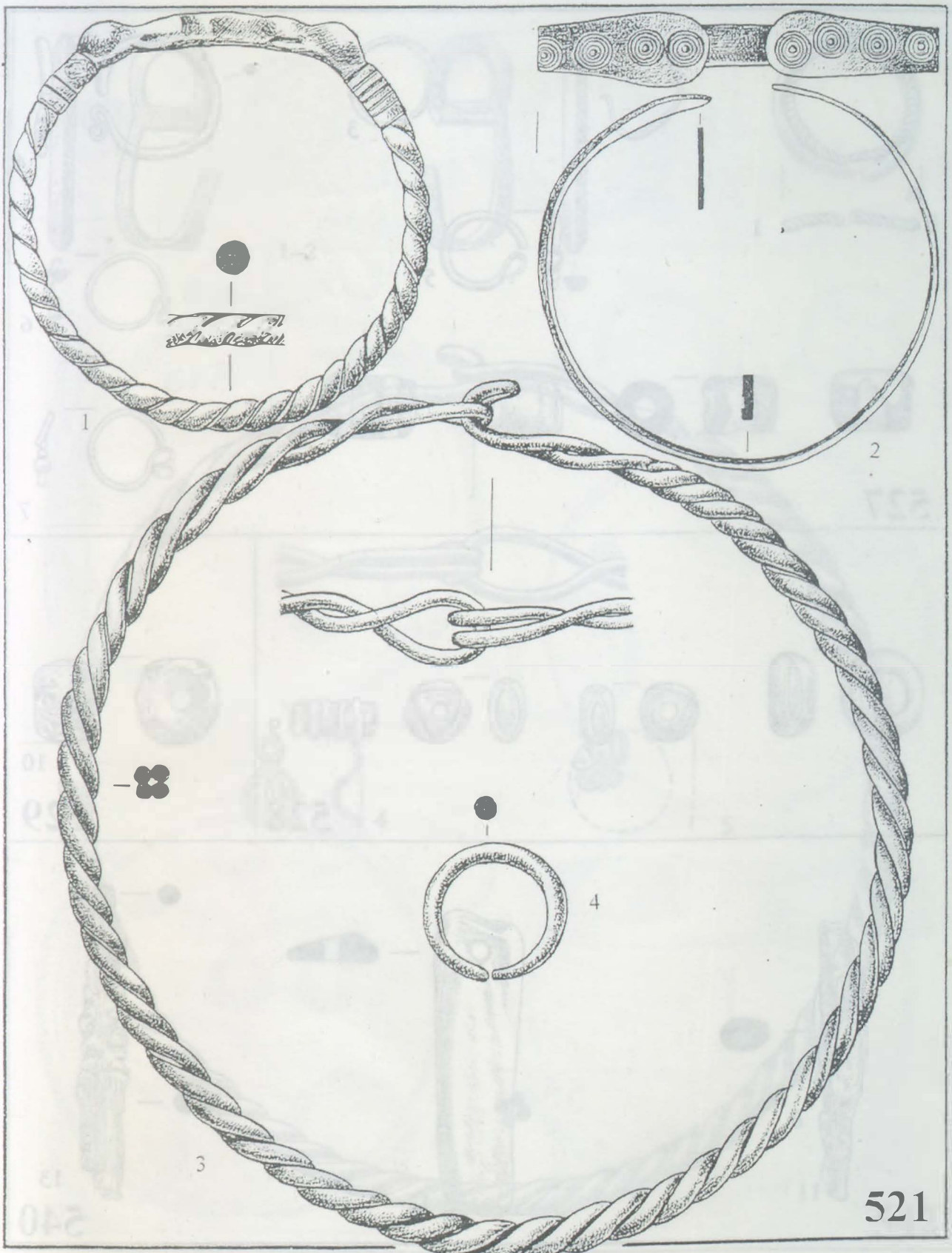

213. tábla: Püspökladány-Eperjesvölgy. 521. sír (1:1)

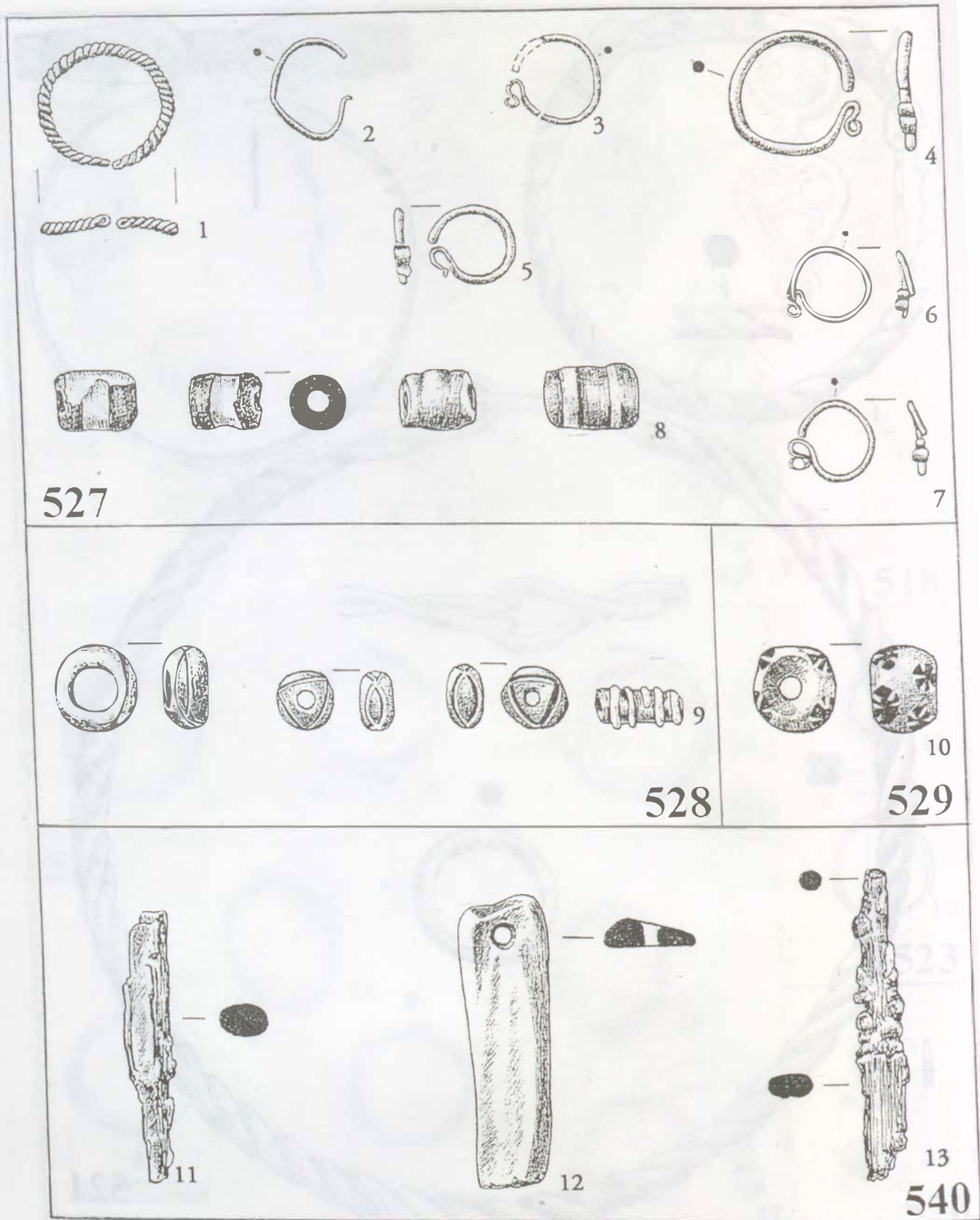

214. tábla: Püspökladány-Eperjesvölgy. 527-529., 540. sír (1:1)

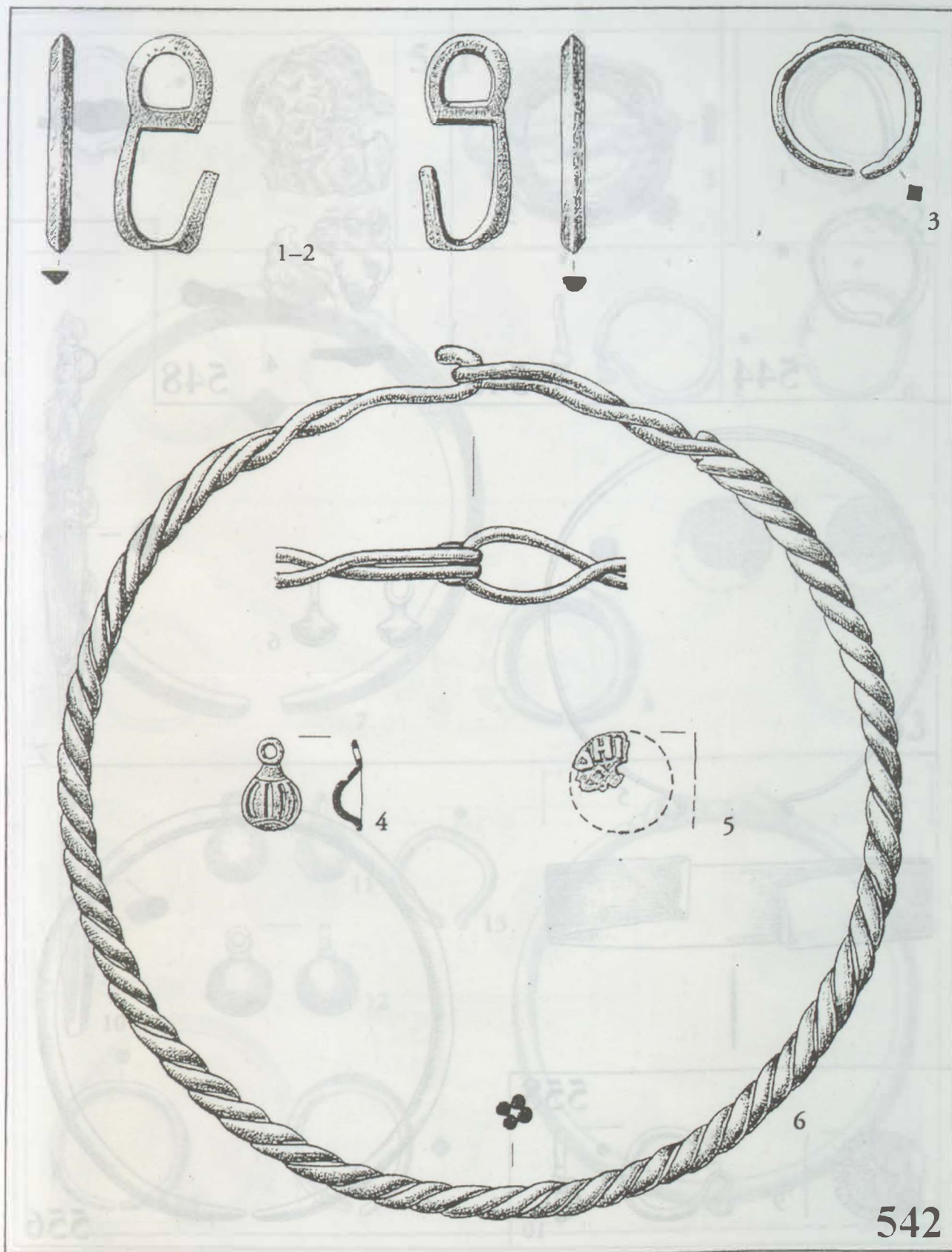

215. tábla: Püspökladány-Eperjesvölgy, 542. sír (1:1)

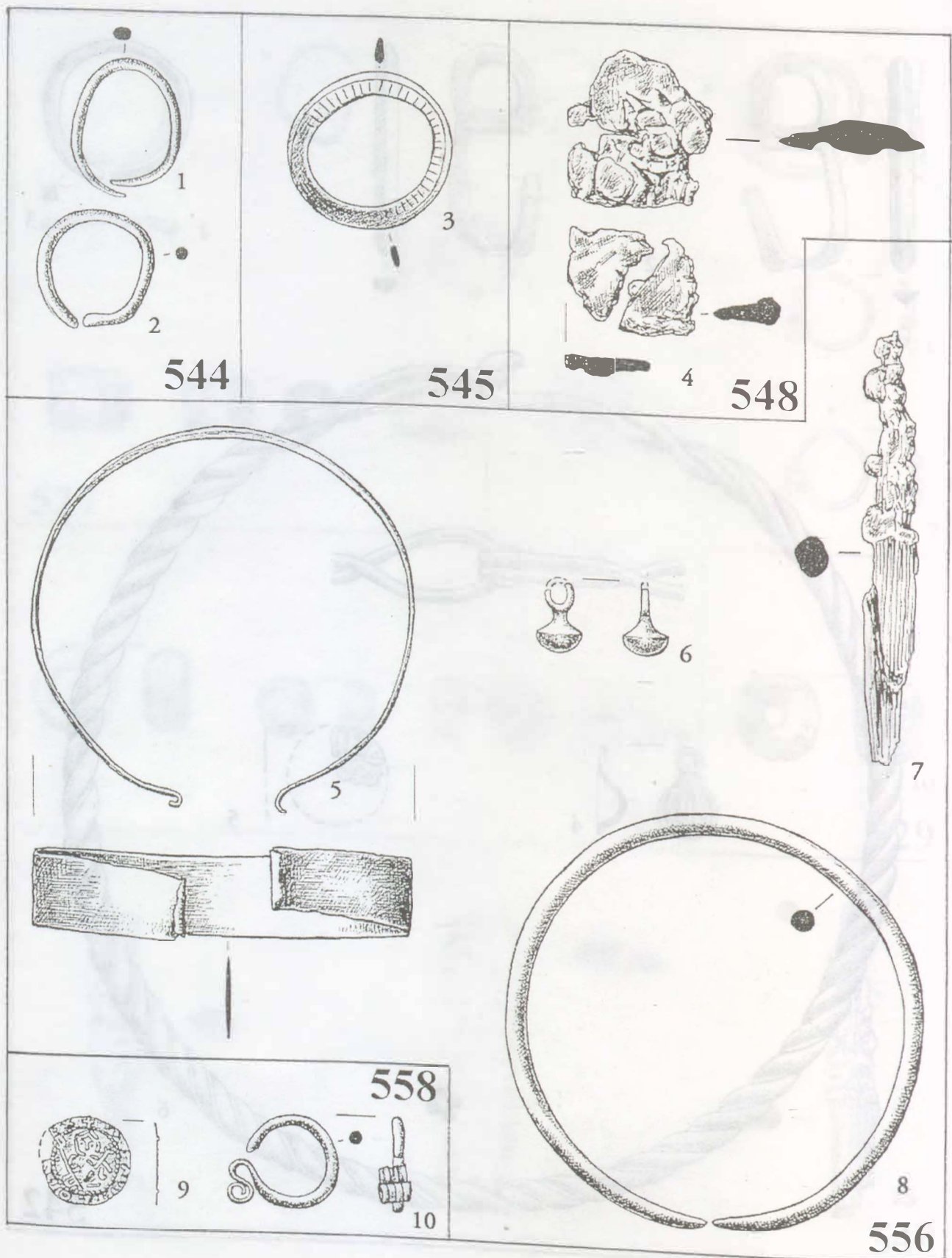

216. tábla: Püspökladány-Eperjesvölgy. 544–545., 548., 556., 558. sír (1:1)

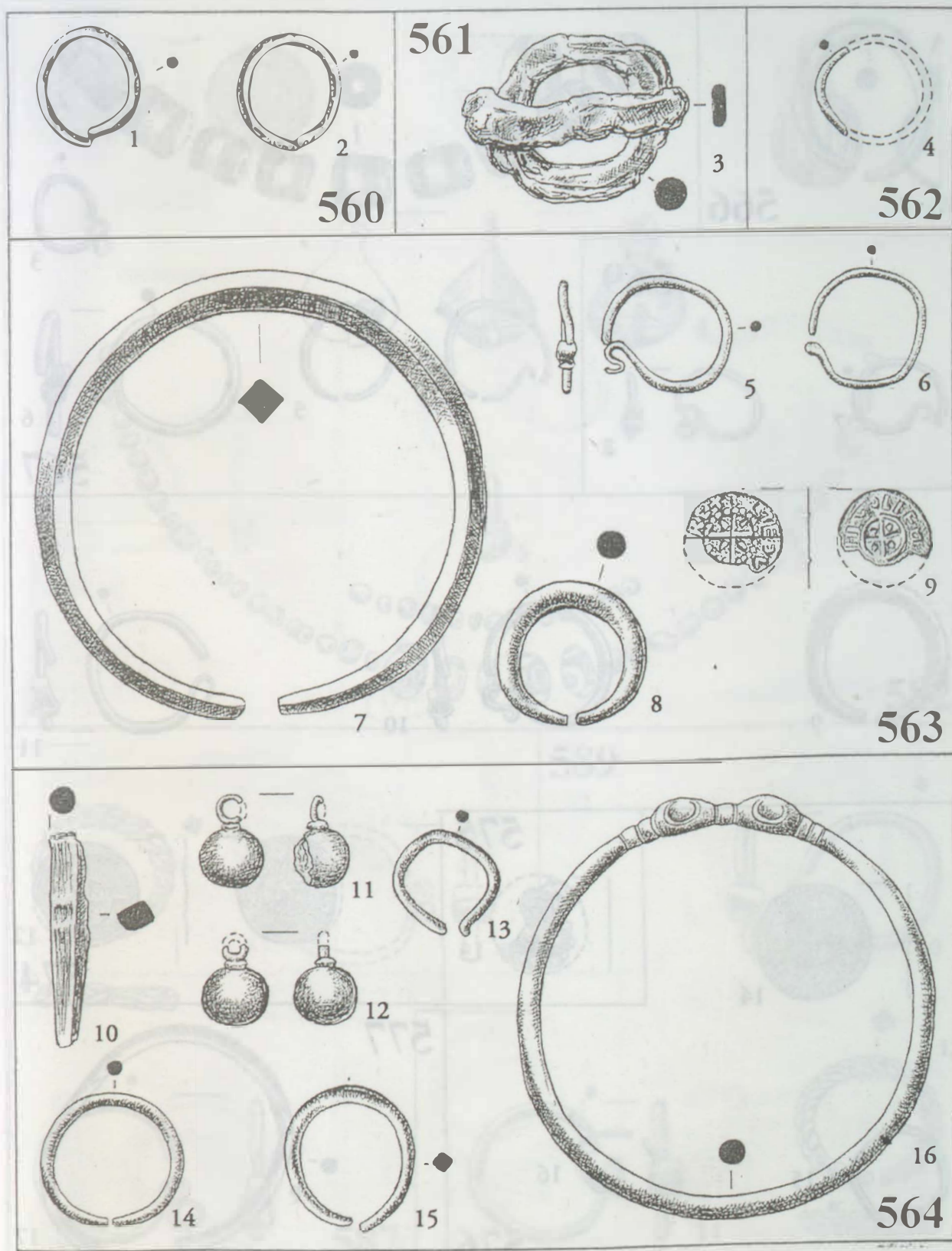

217. tábla: Püspökladány-Eperjesvölgy. 560-564. sír (1:1)

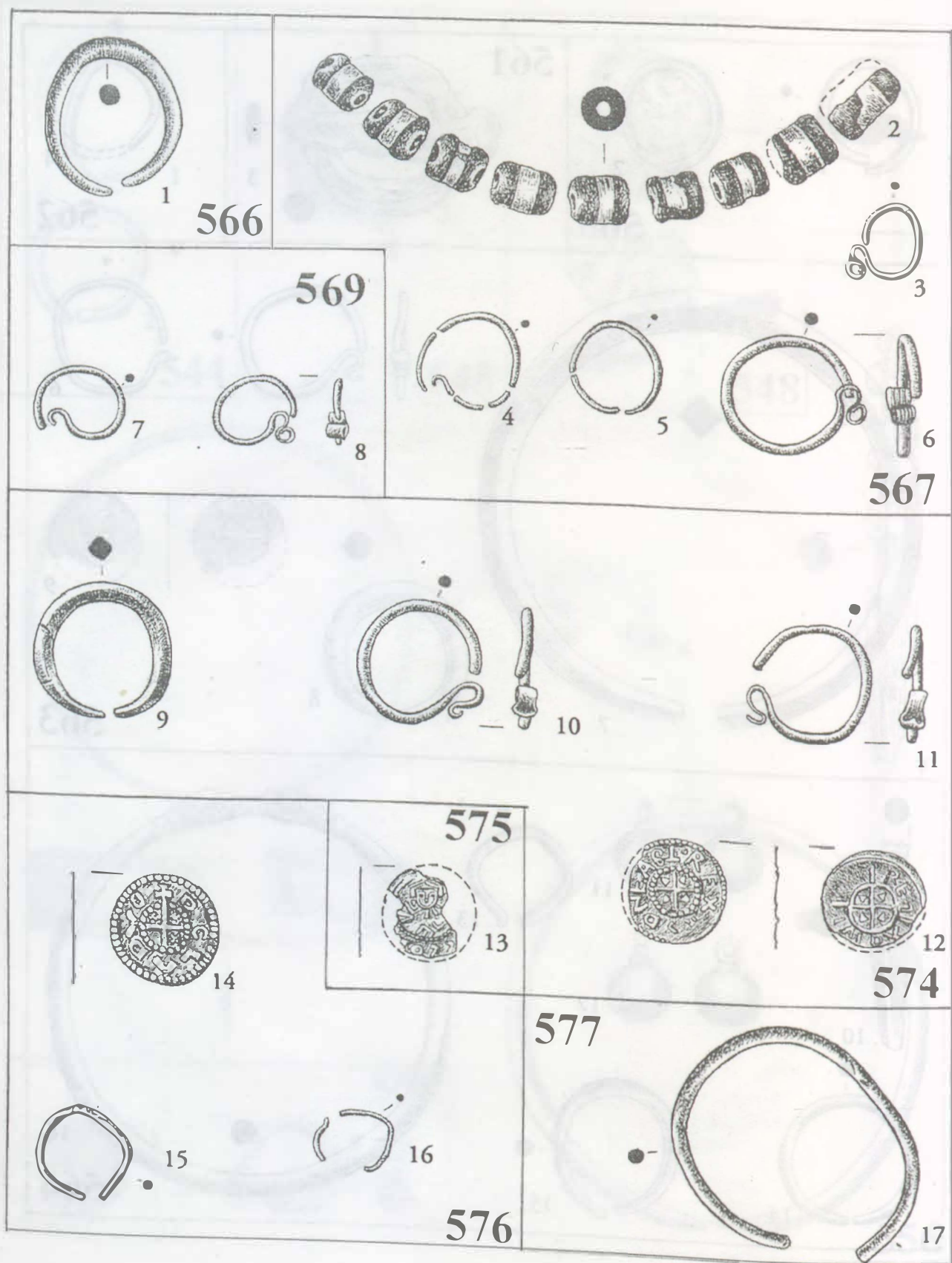

218. tábla: Püspökladány-Eperjesvölgy. 566–567., 569., 574–577. sír (1:1)

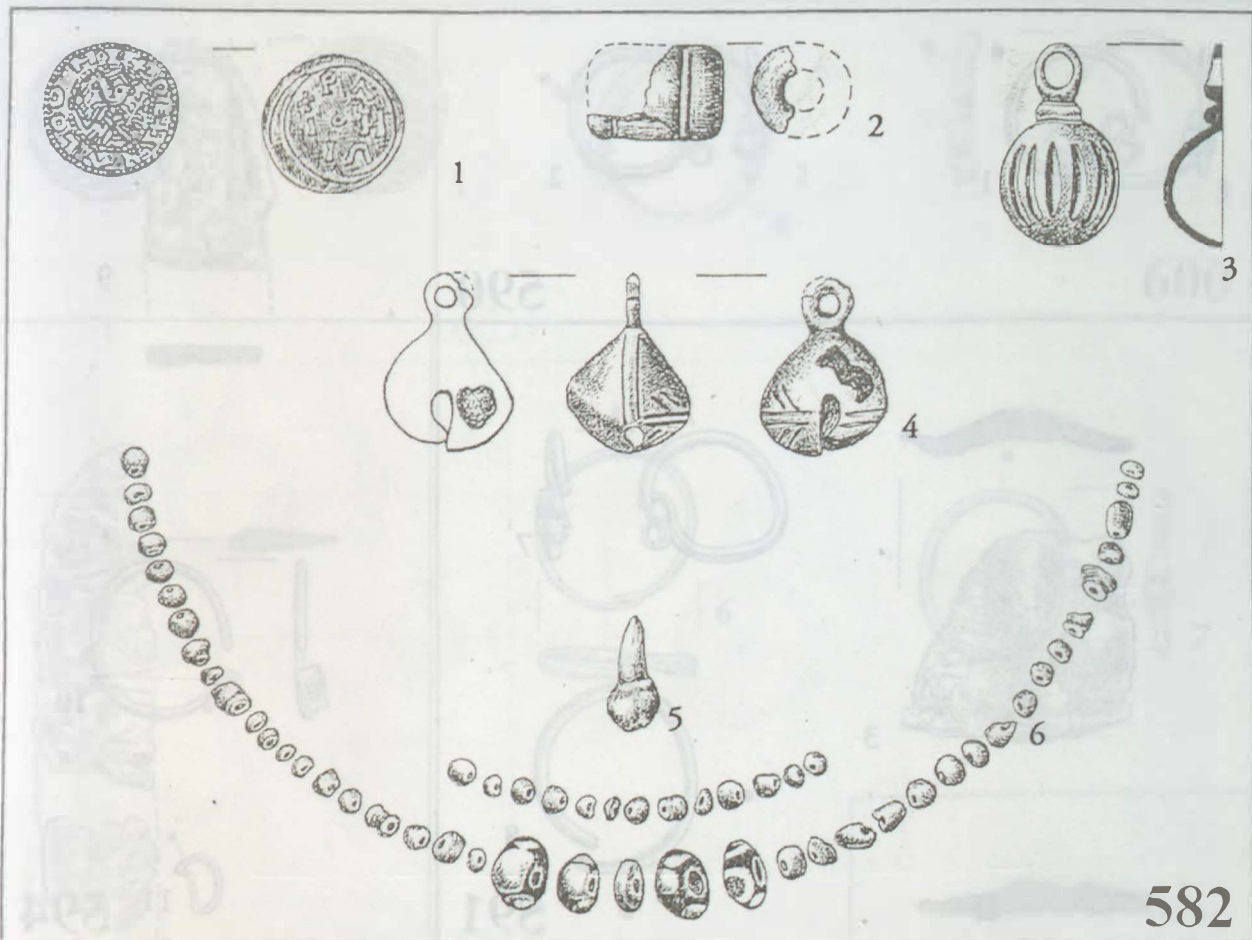

582

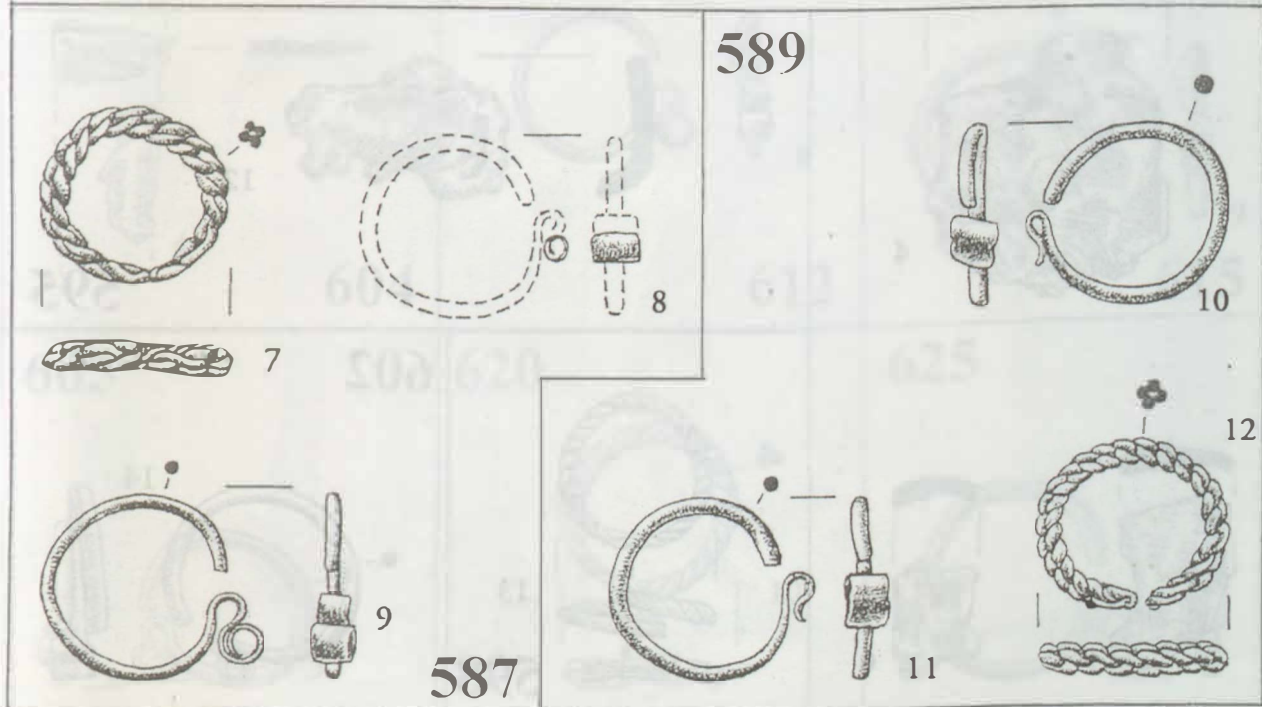

589

587

219. tábla: Püspökladány-Eperjesvölgy. 582., 587., 589. sír (1:1)

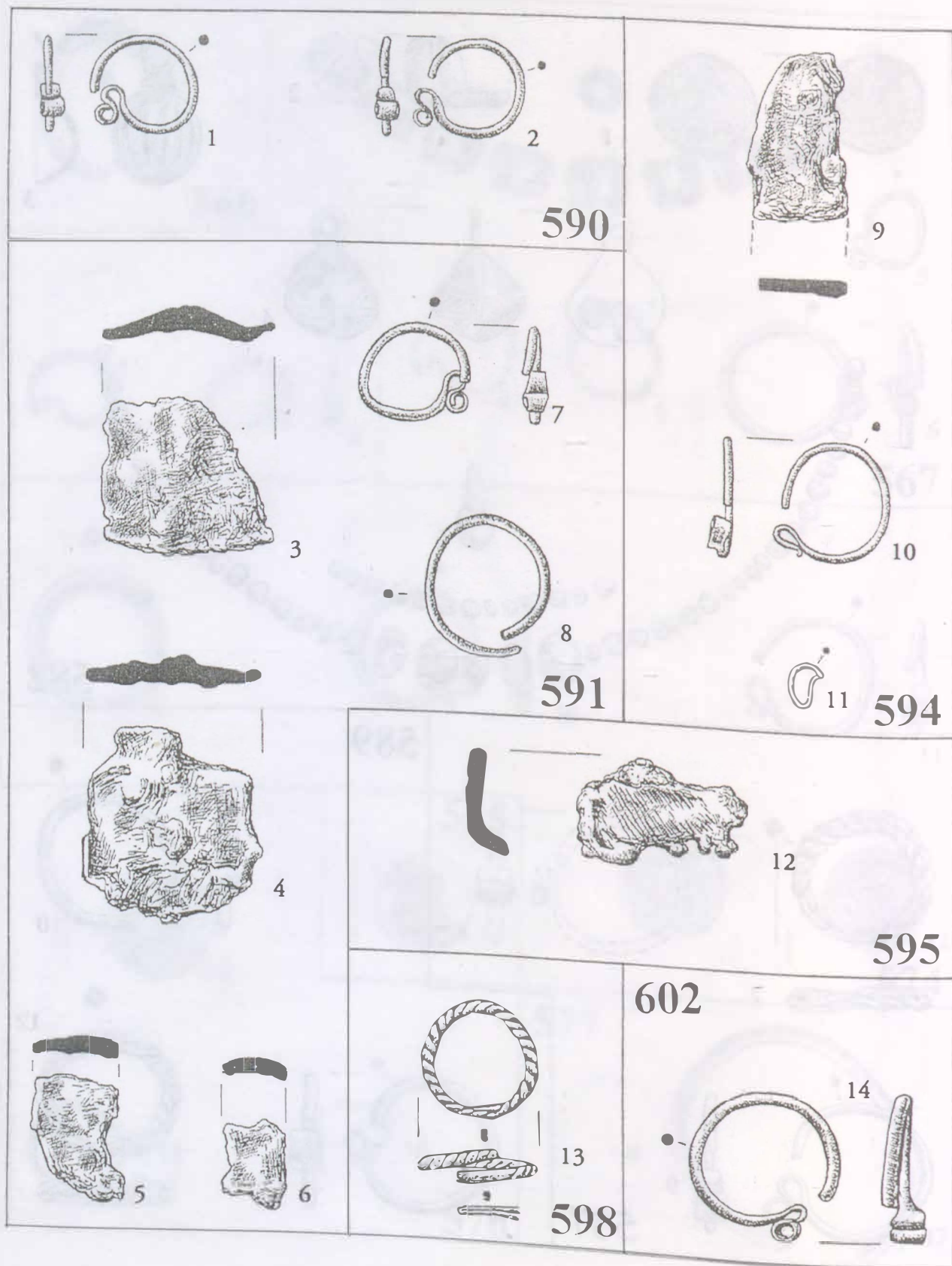

220. tábla: Püspökladány-Eperjesvölgy. 590-591., 594-595., 598., 602. sír (1:1)

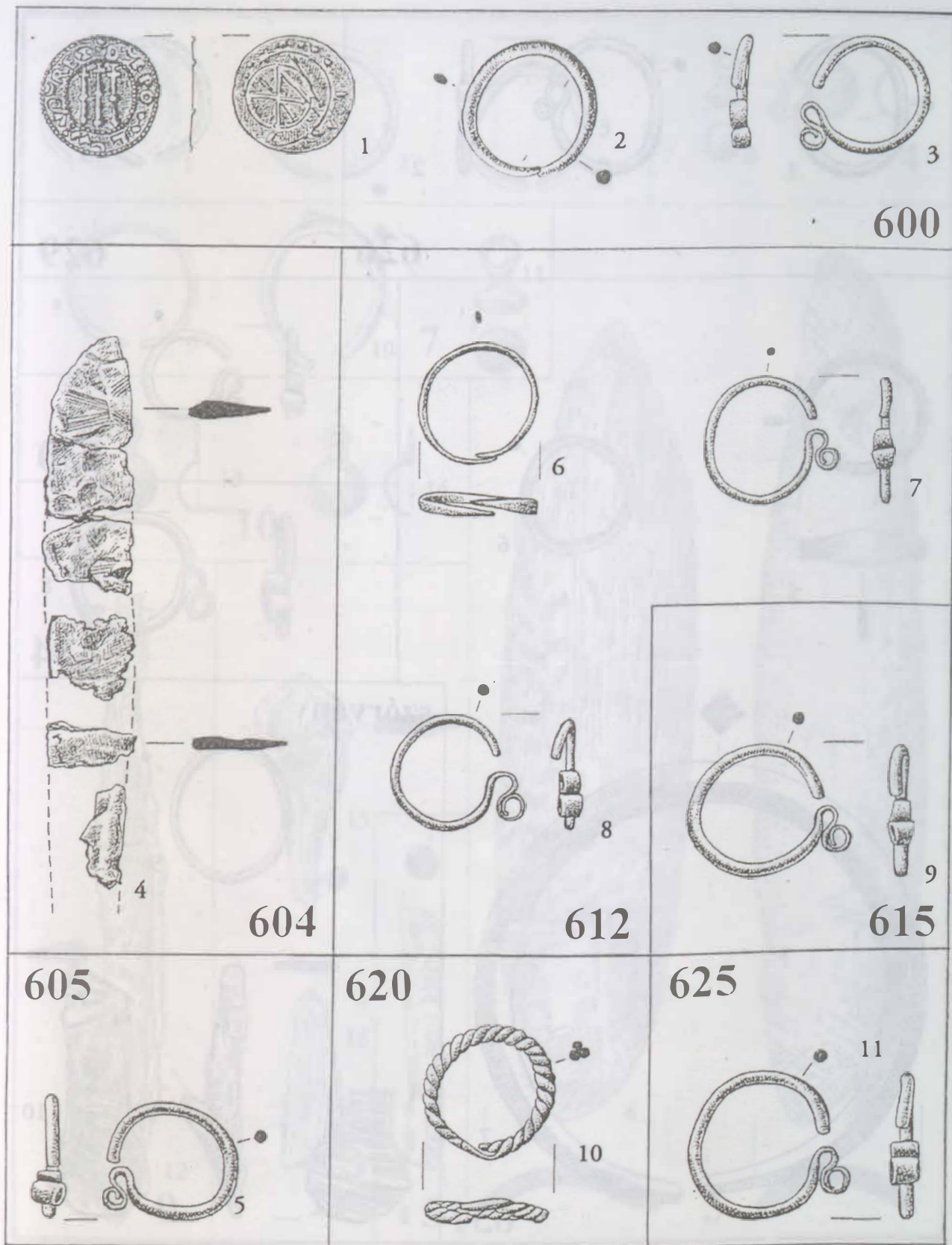

221. tábla: Püspökladány-Eperjesvölgy. 600., 604–605., 612., 615., 620., 625. sír (1:1)

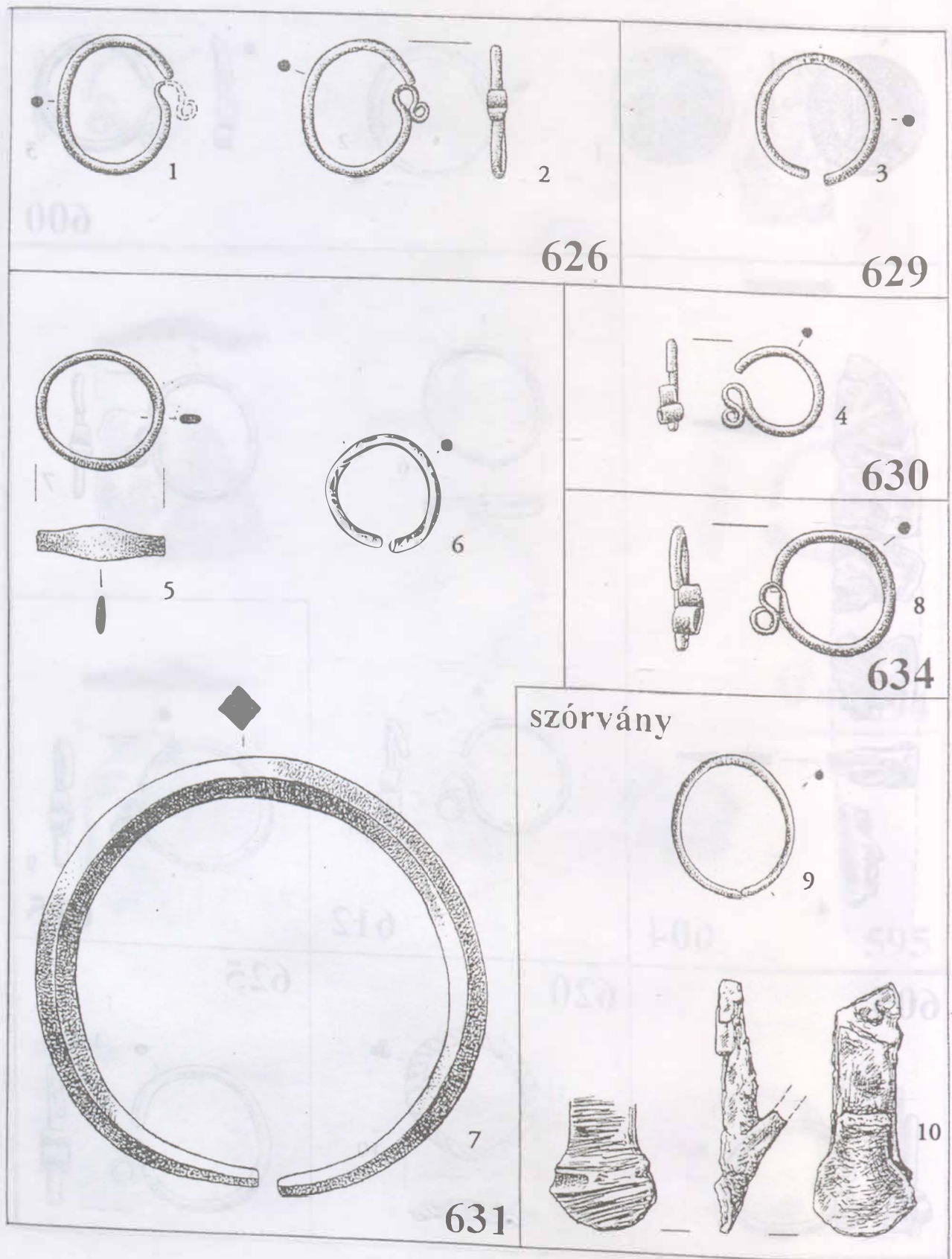

222. tábla: Püspökladány-Eperjesvölgy. 626., 629–631., 634. sír és szórvány (1:1)

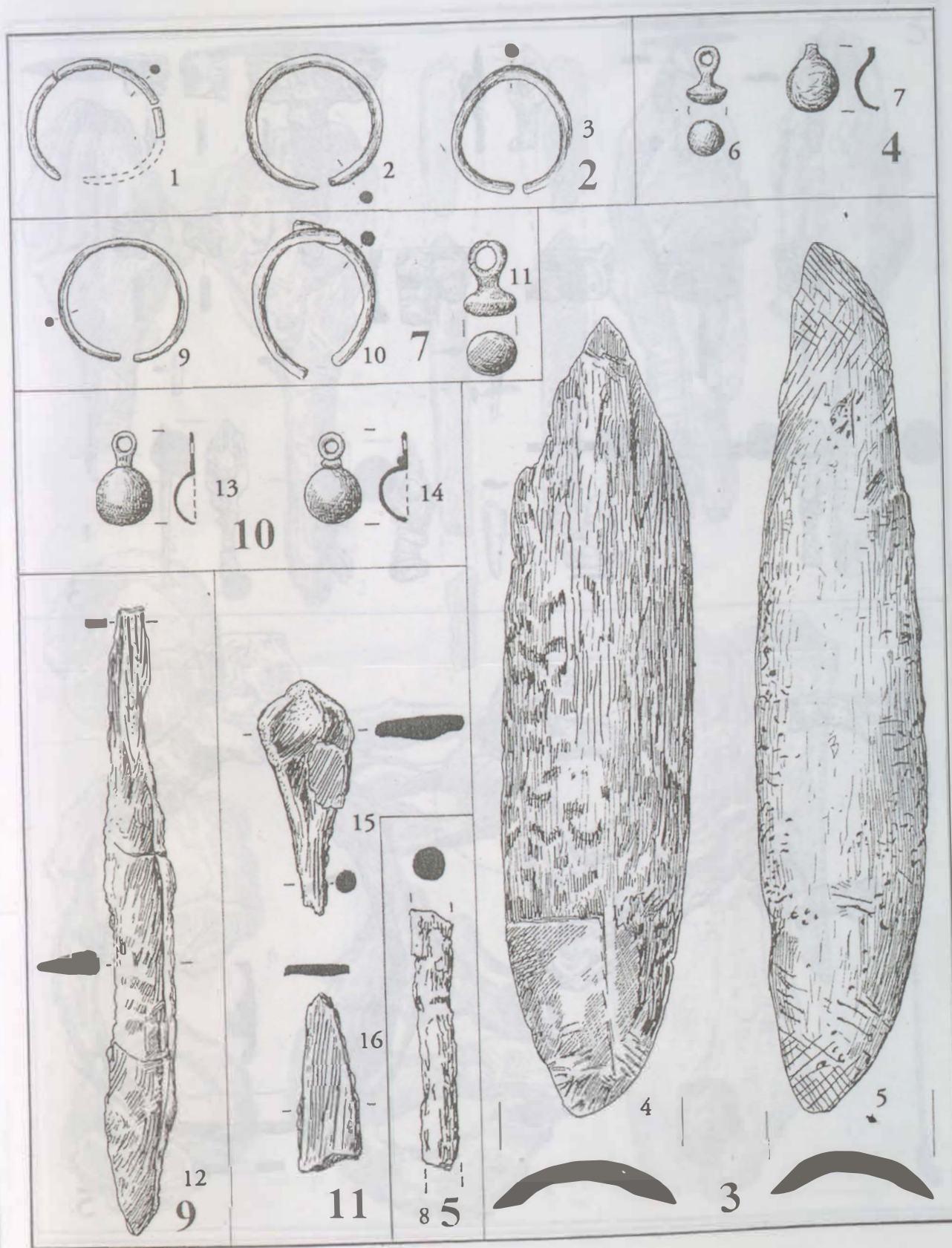

223. tábla: Sárretudvari-Hízföld. 2-5., 7., 9-11. sír (1:1)

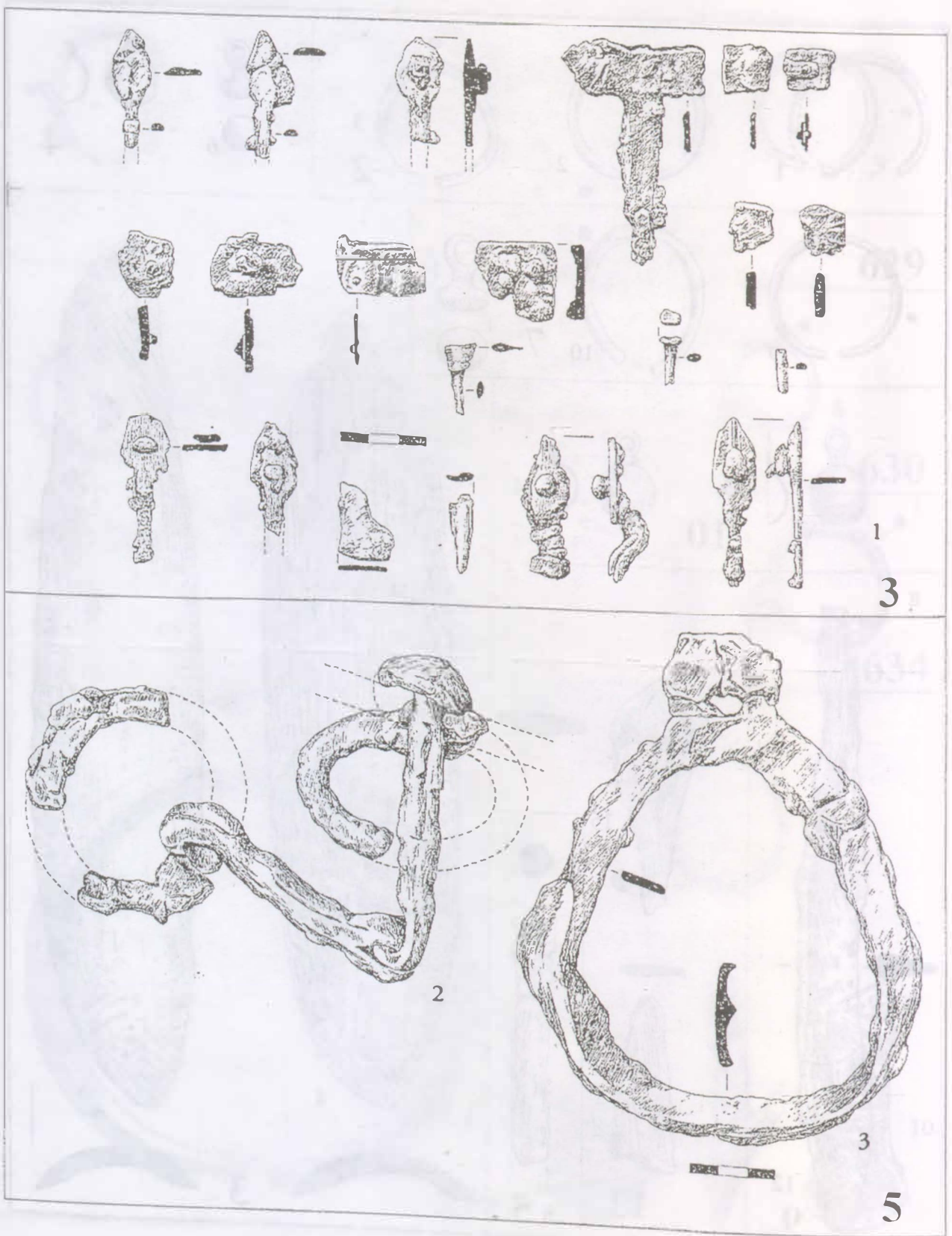

224. tábla: Sárrétudvari-Hízóföld. 3., 5. sír (1:2)

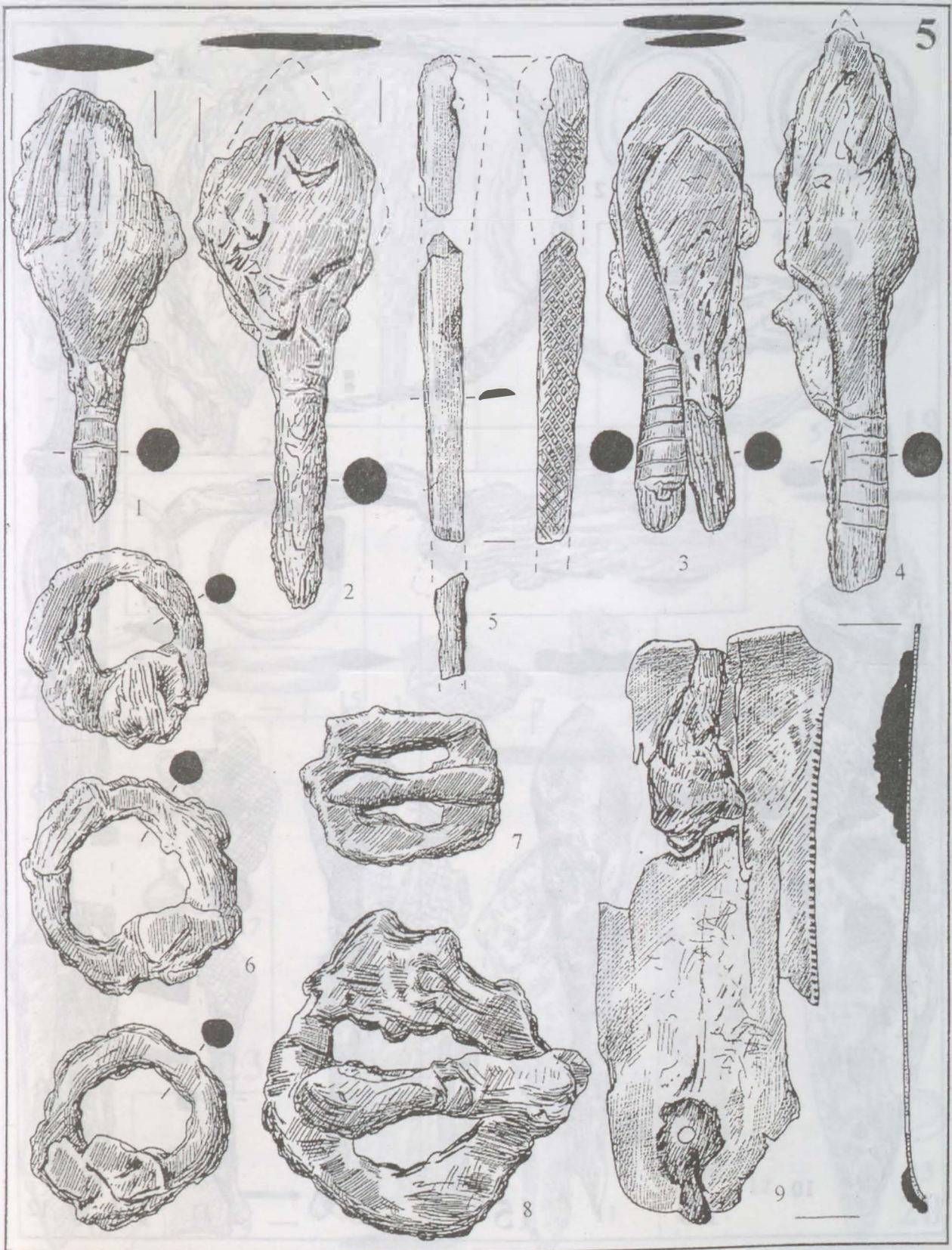

225. tábla: Sárrétudvari-Hízófold. 5. sír (1:1)

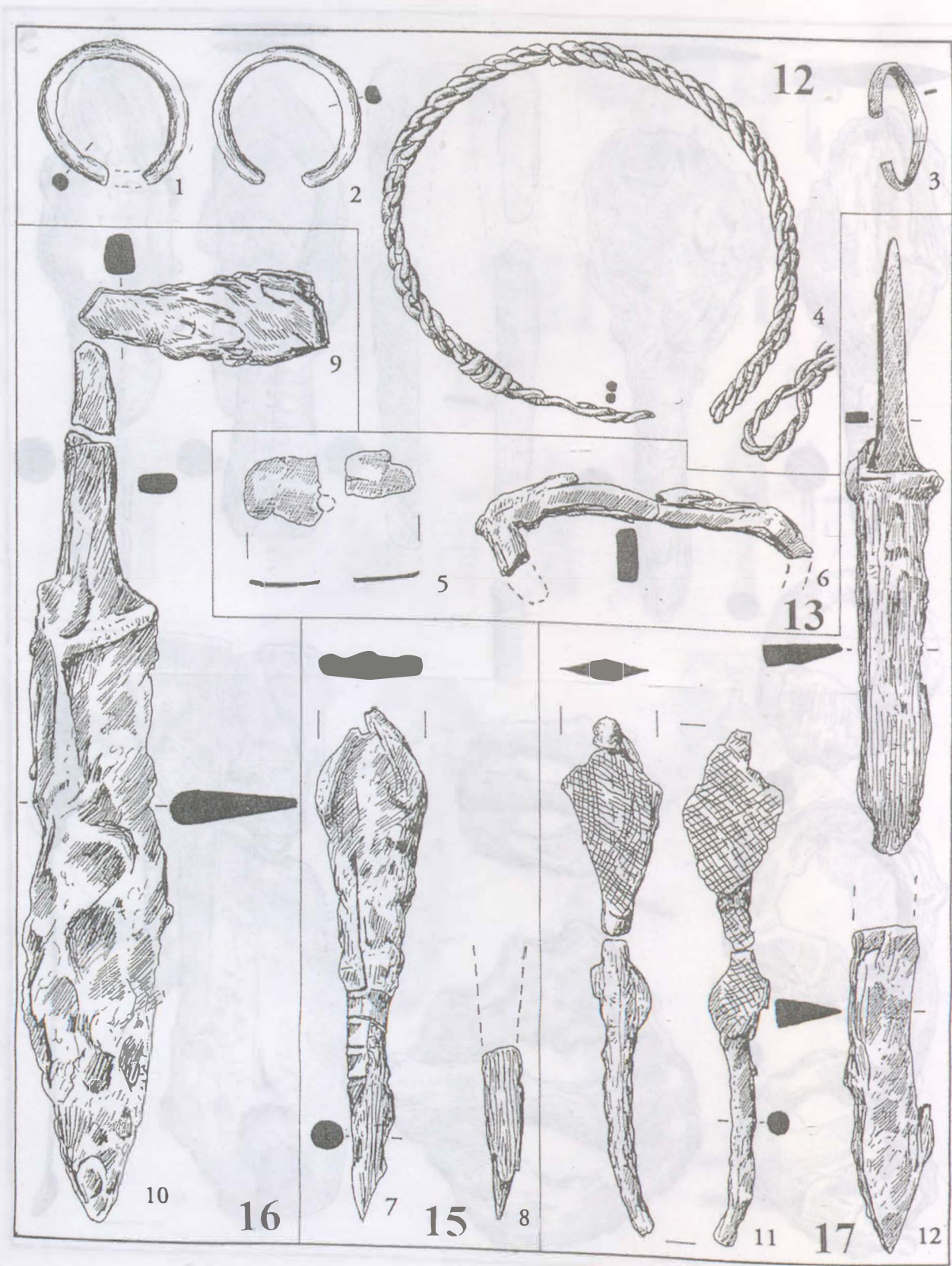

226. tábla: Sárrétudvari-Hízóföld. 12-13., 15-17. sír (1:1)

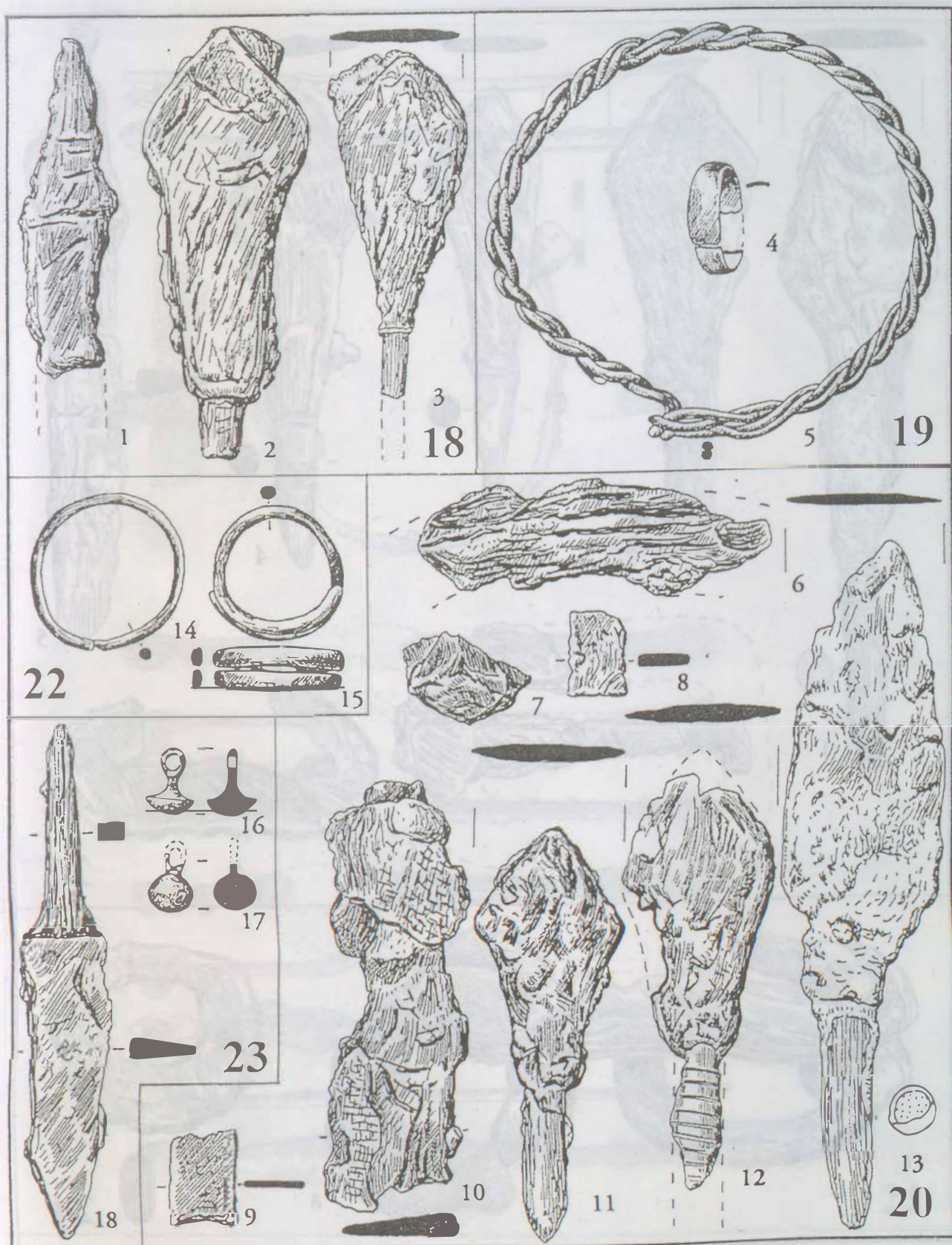

227. tábla: Sárrétudvari-Hízófold. 18–20., 22–23. sír (1:1)

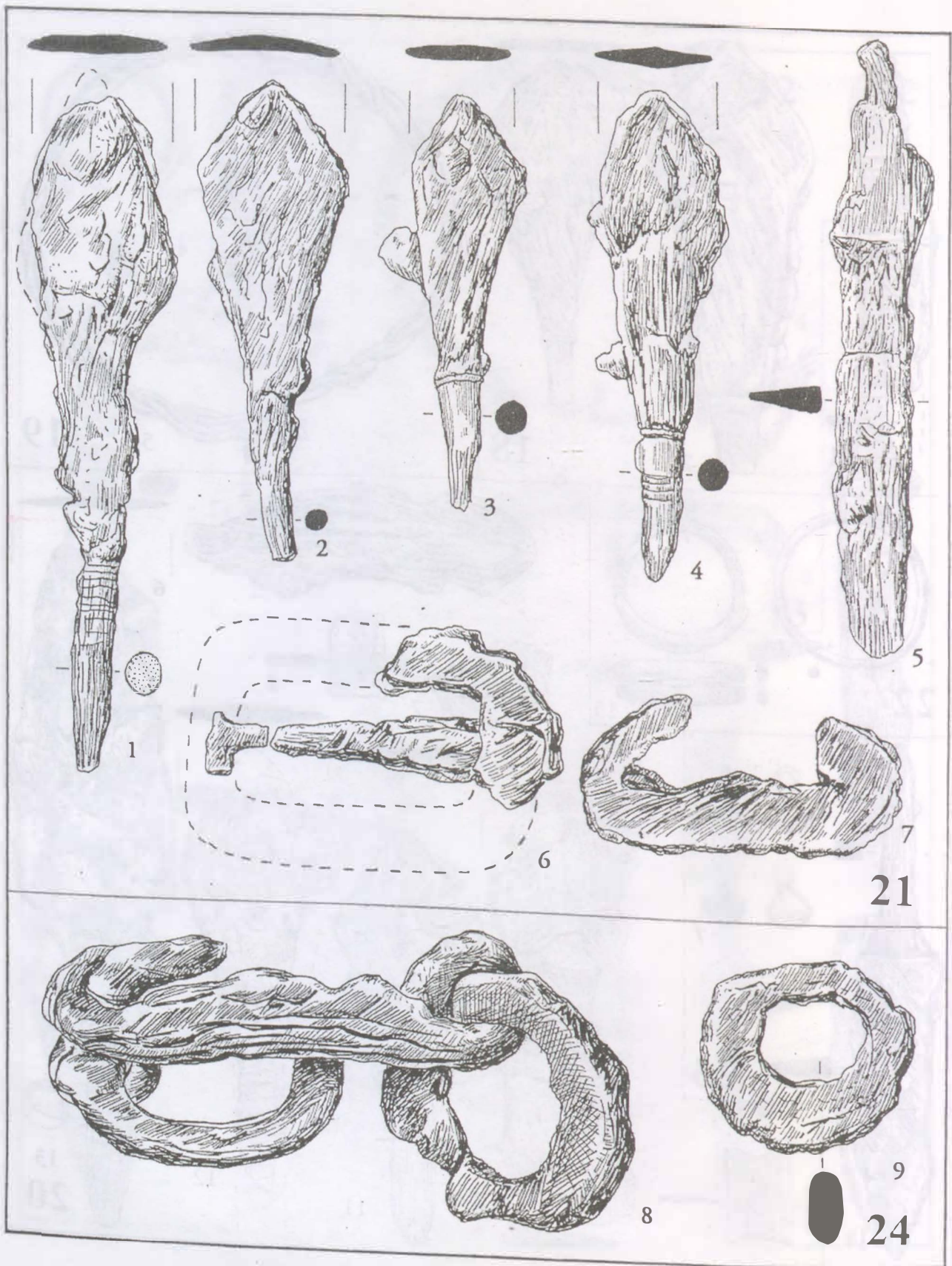

228. tábla: Sárretudvari-Hízófold. 21., 24. sír (1:1)

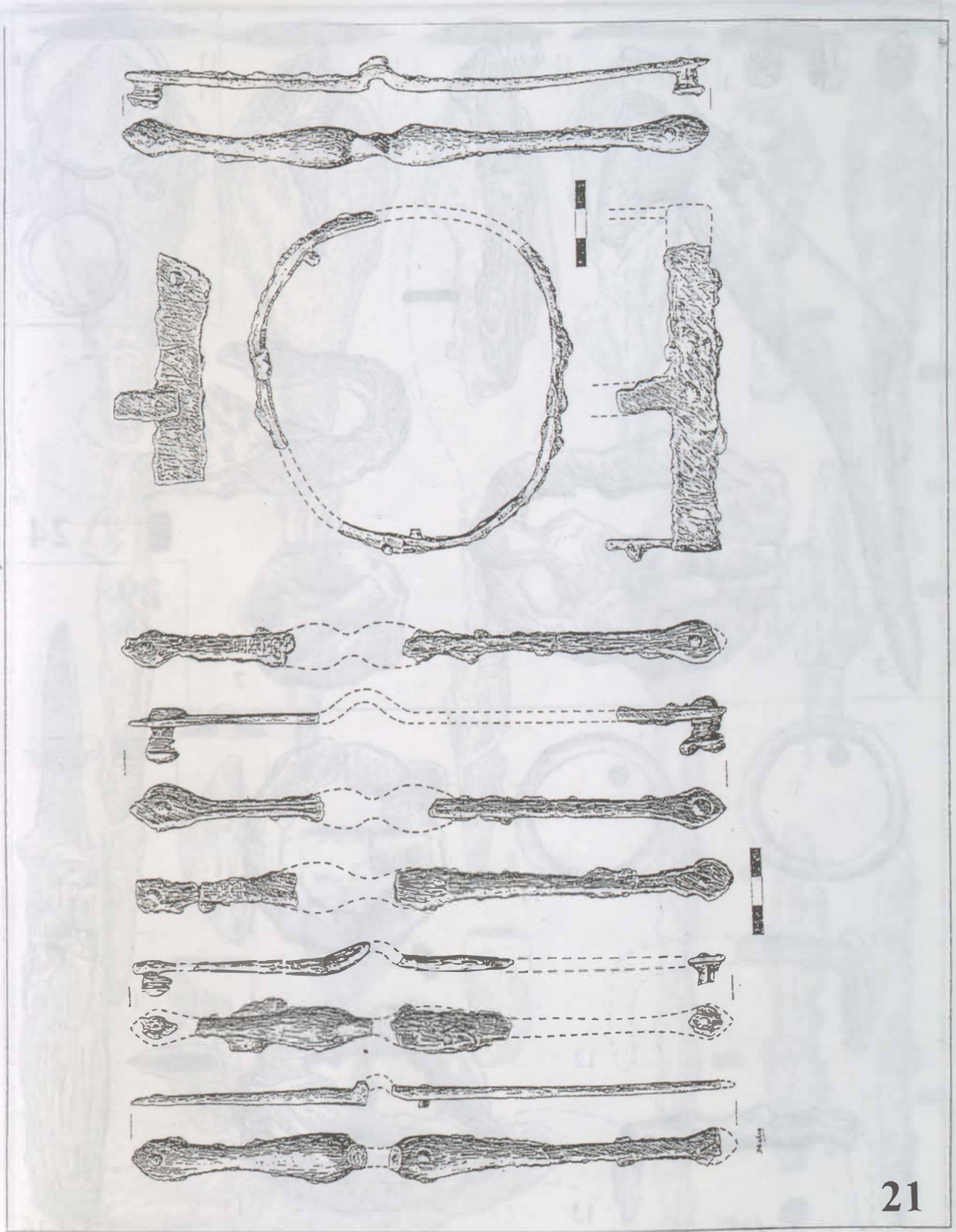

21

229. tábla: Sárretudvari-Hízóföld. 21. sír (1:2)

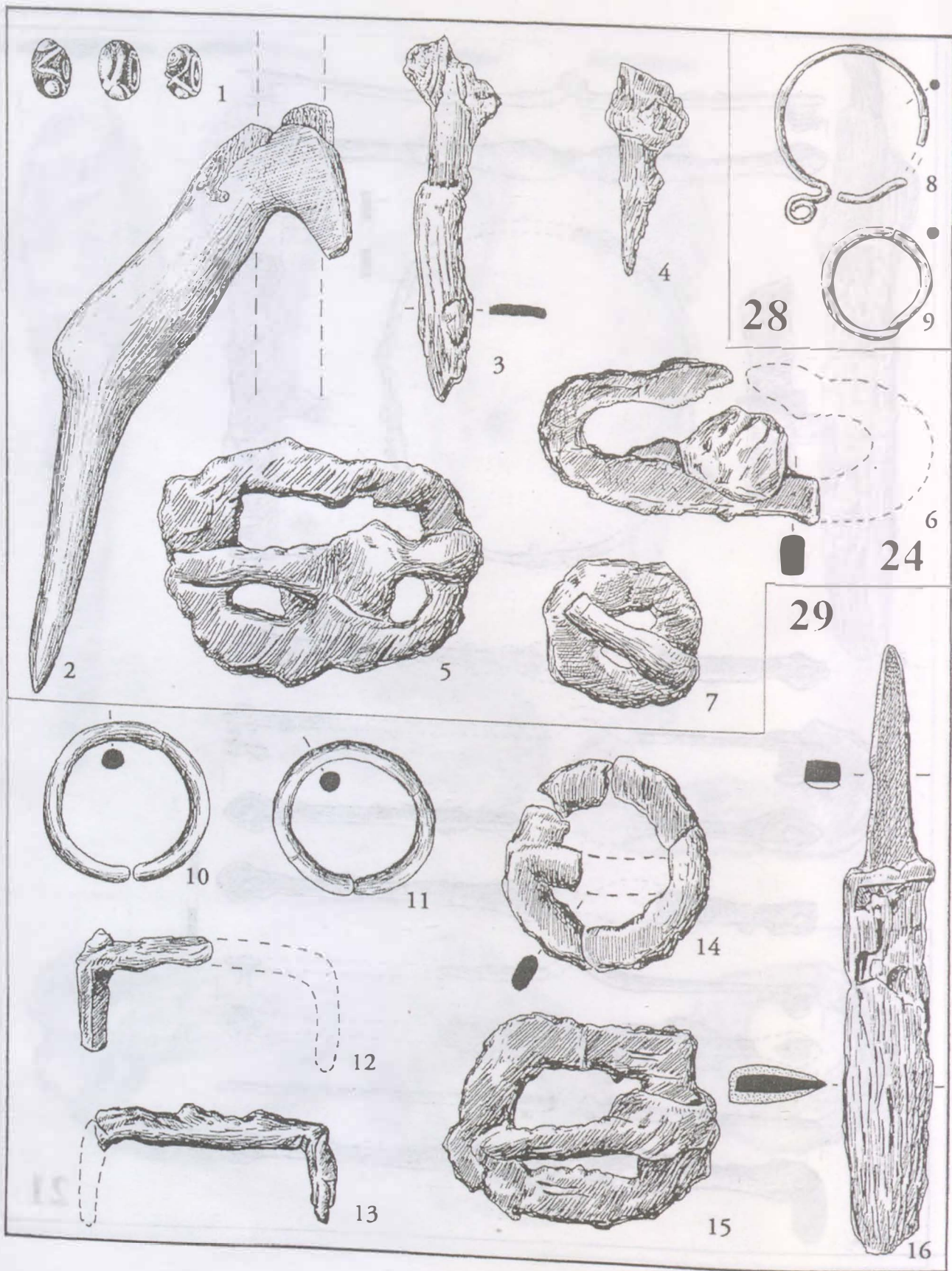

230. tábla: Sárrétudvari-Hízóföld. 24., 28., 29. sír (1:1)

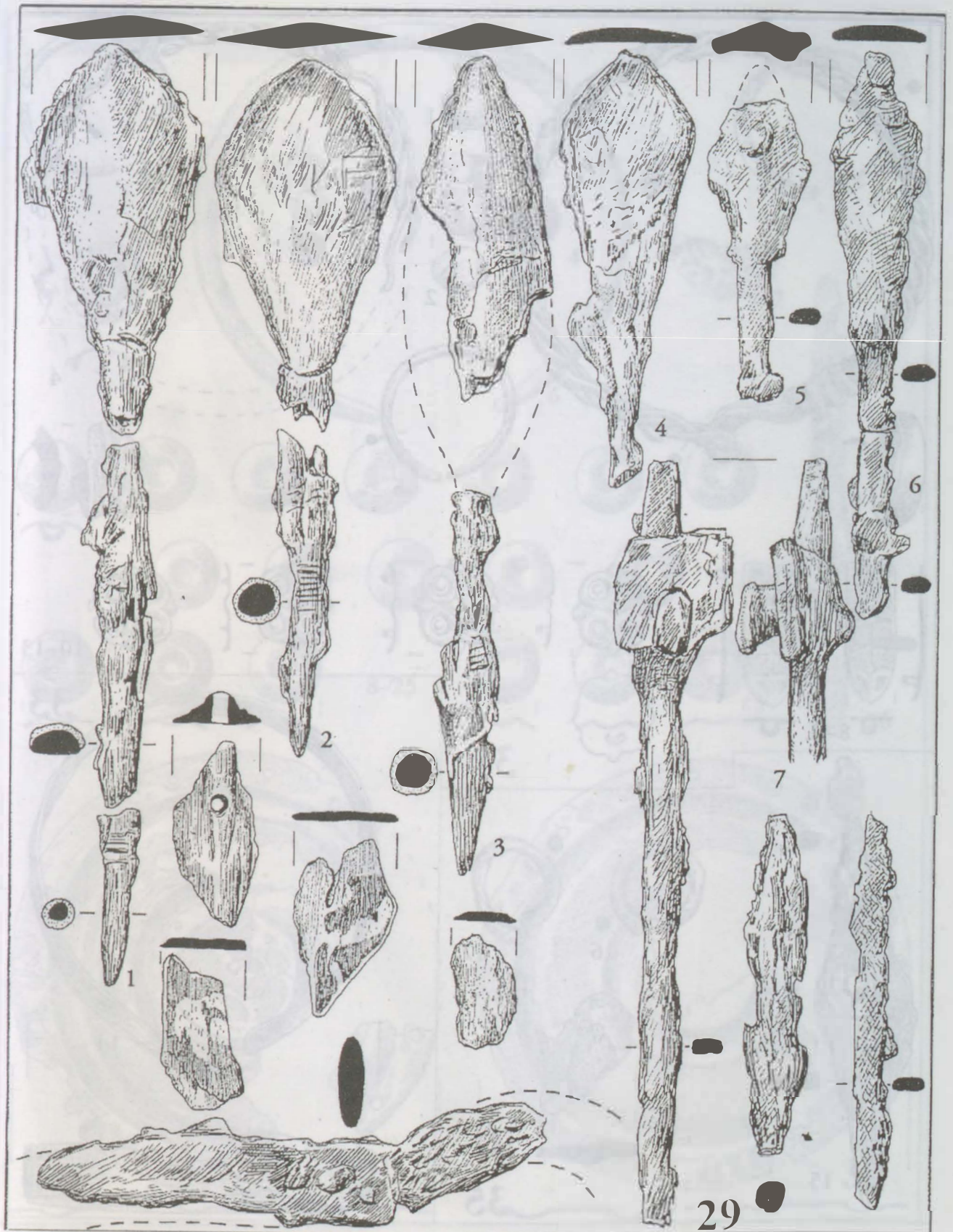

231. tábla: Sárretudvari-Hízóföld. 29. sár (1:1)

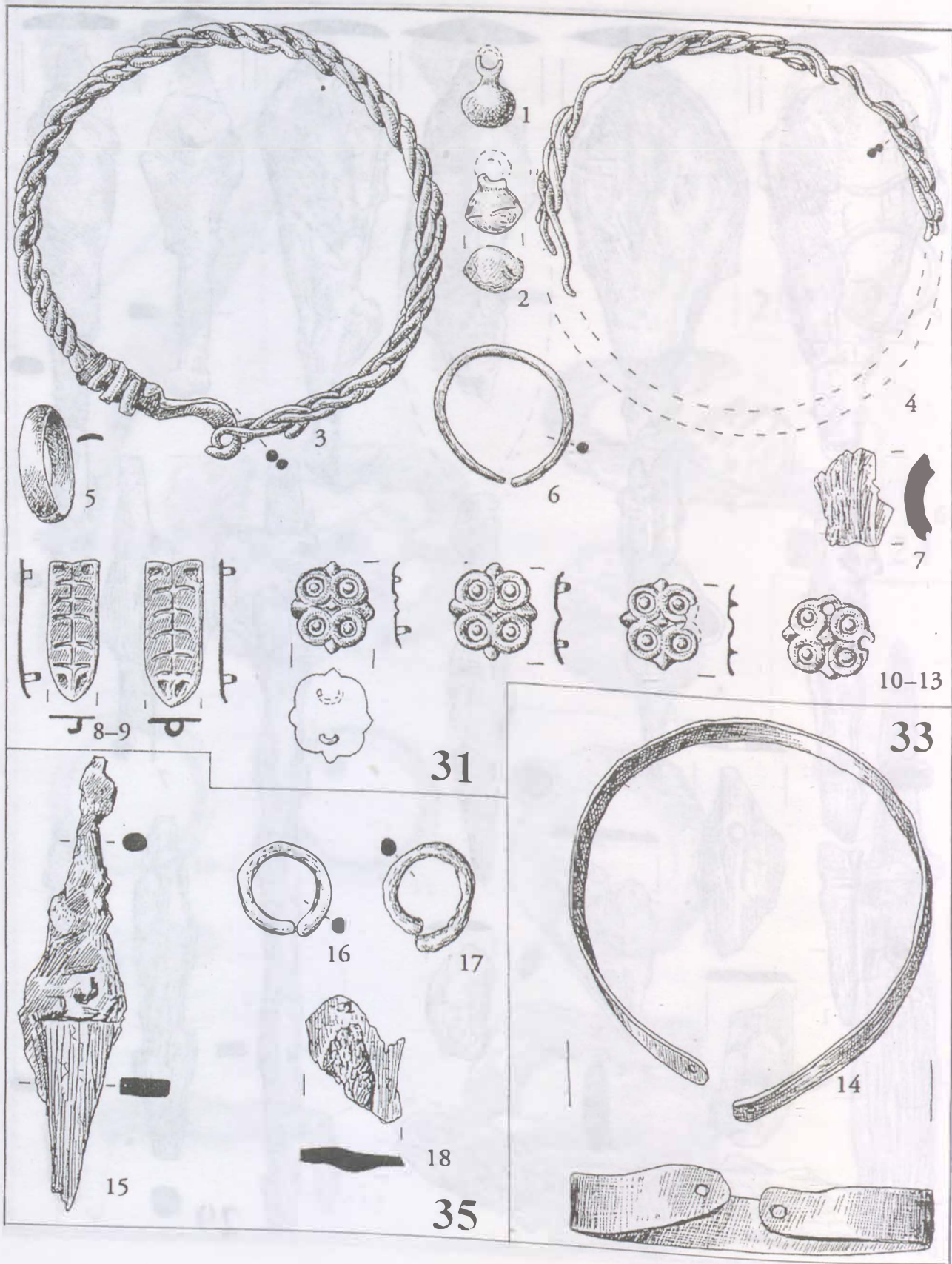

232. tábla: Sárrétudvari-Hízóföld. 31., 33., 35. sír (1:1)

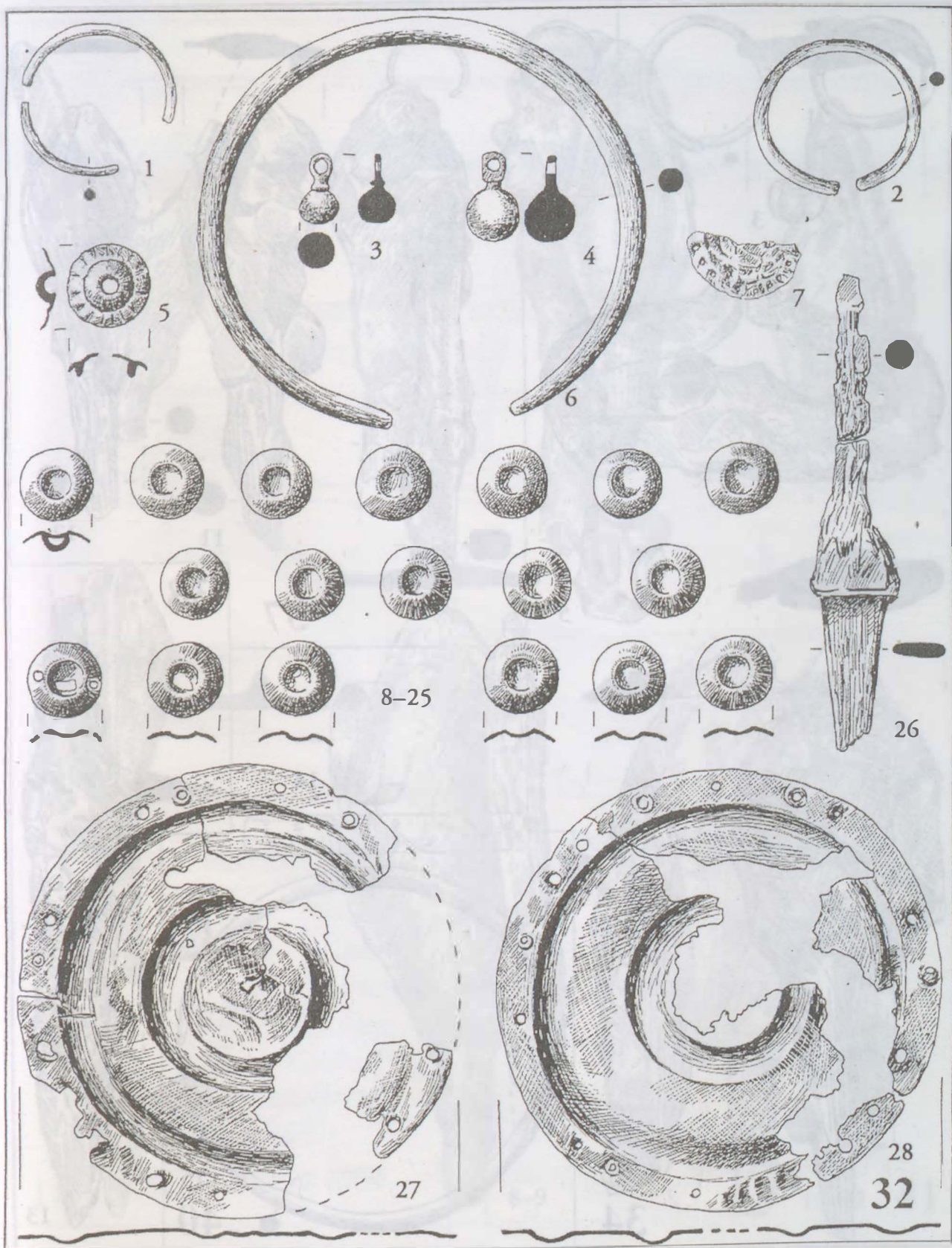

233. tábla: Sárrétudvari-Hízófold. 32. sír (1:1)

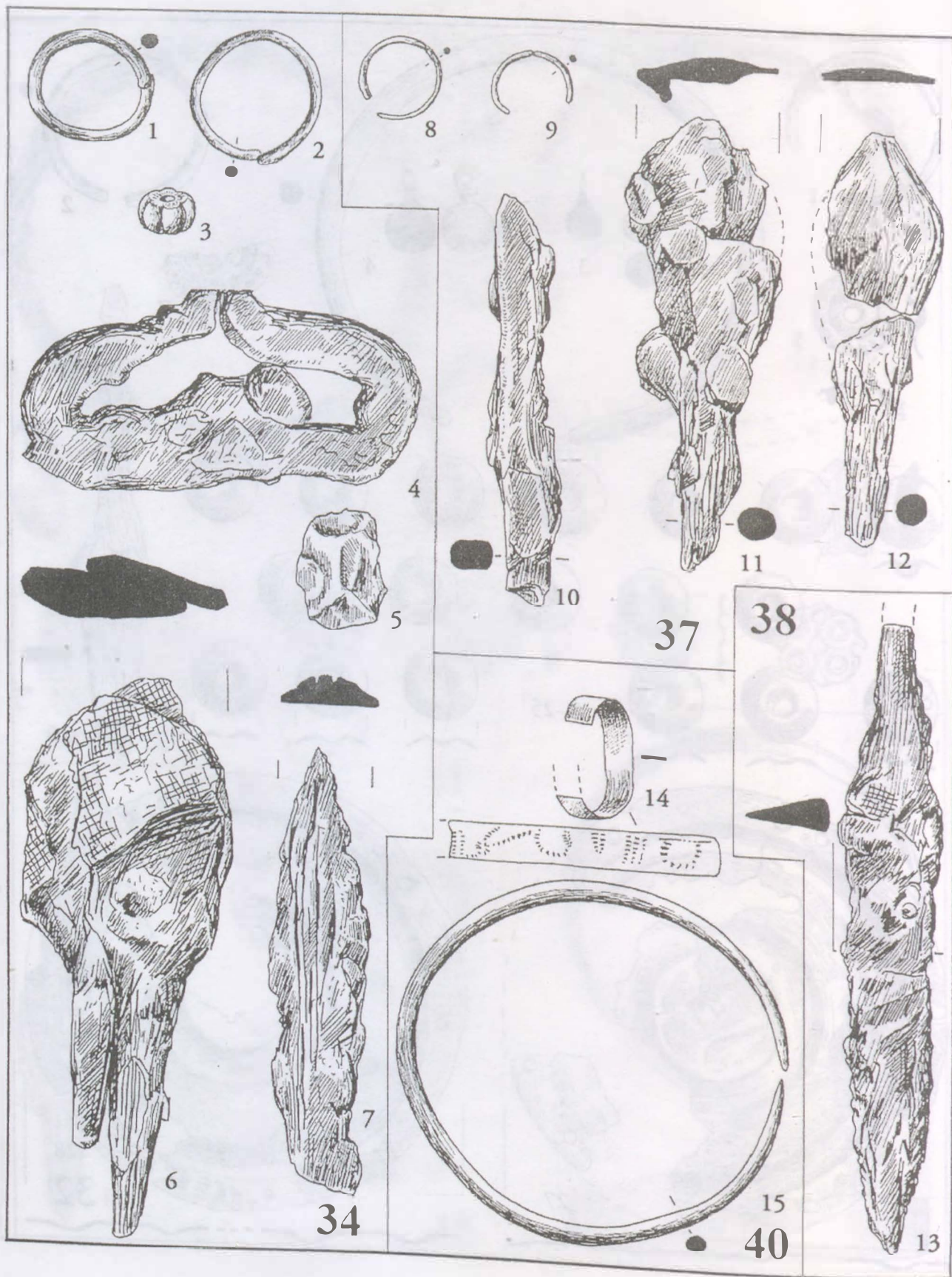

234. tábla: Sárrétudvari-Hízóföld. 34., 37-38., 40. sír (1:1)

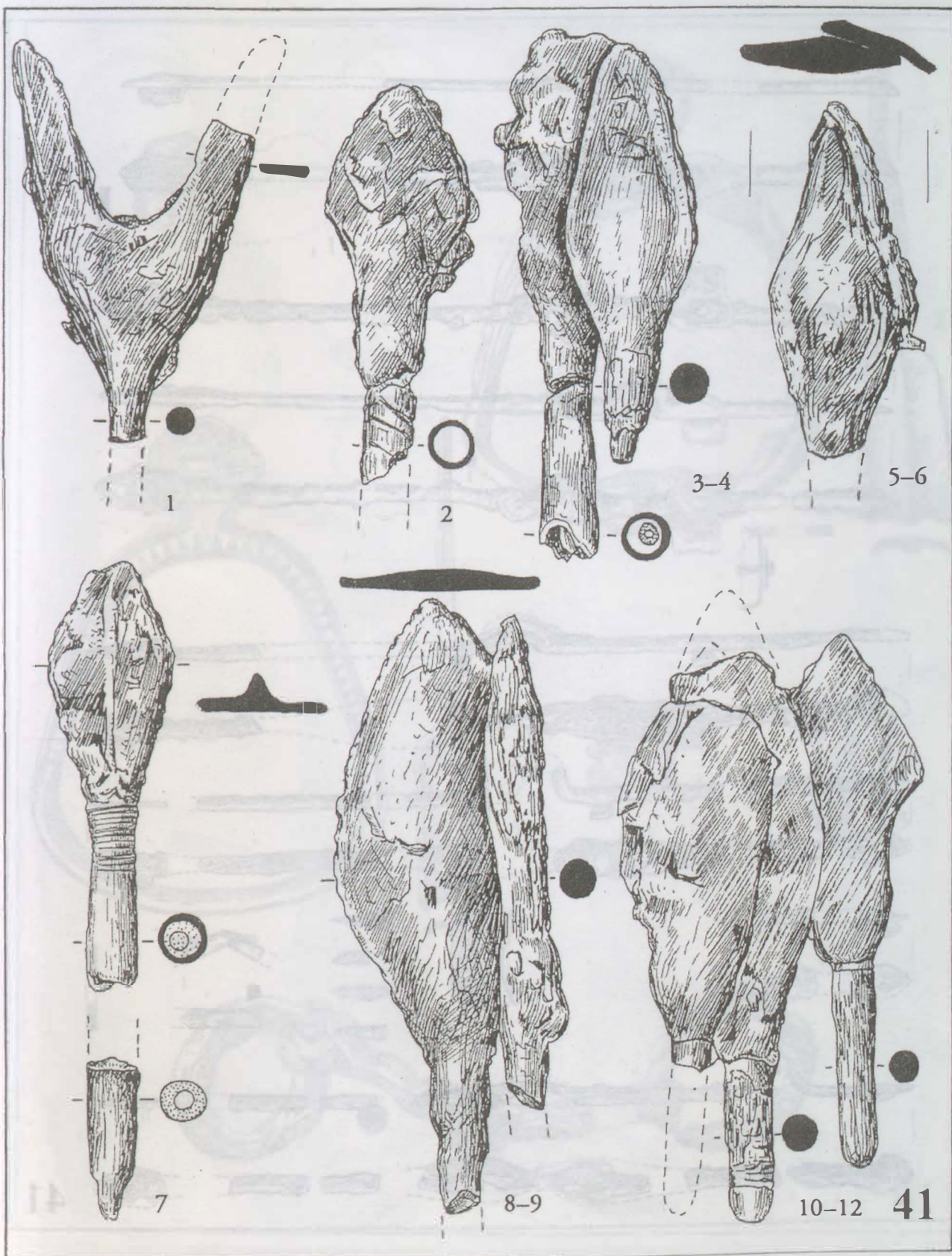

235. tábla: Sárrétudvari-Hízófold. 41. sír (1:1)

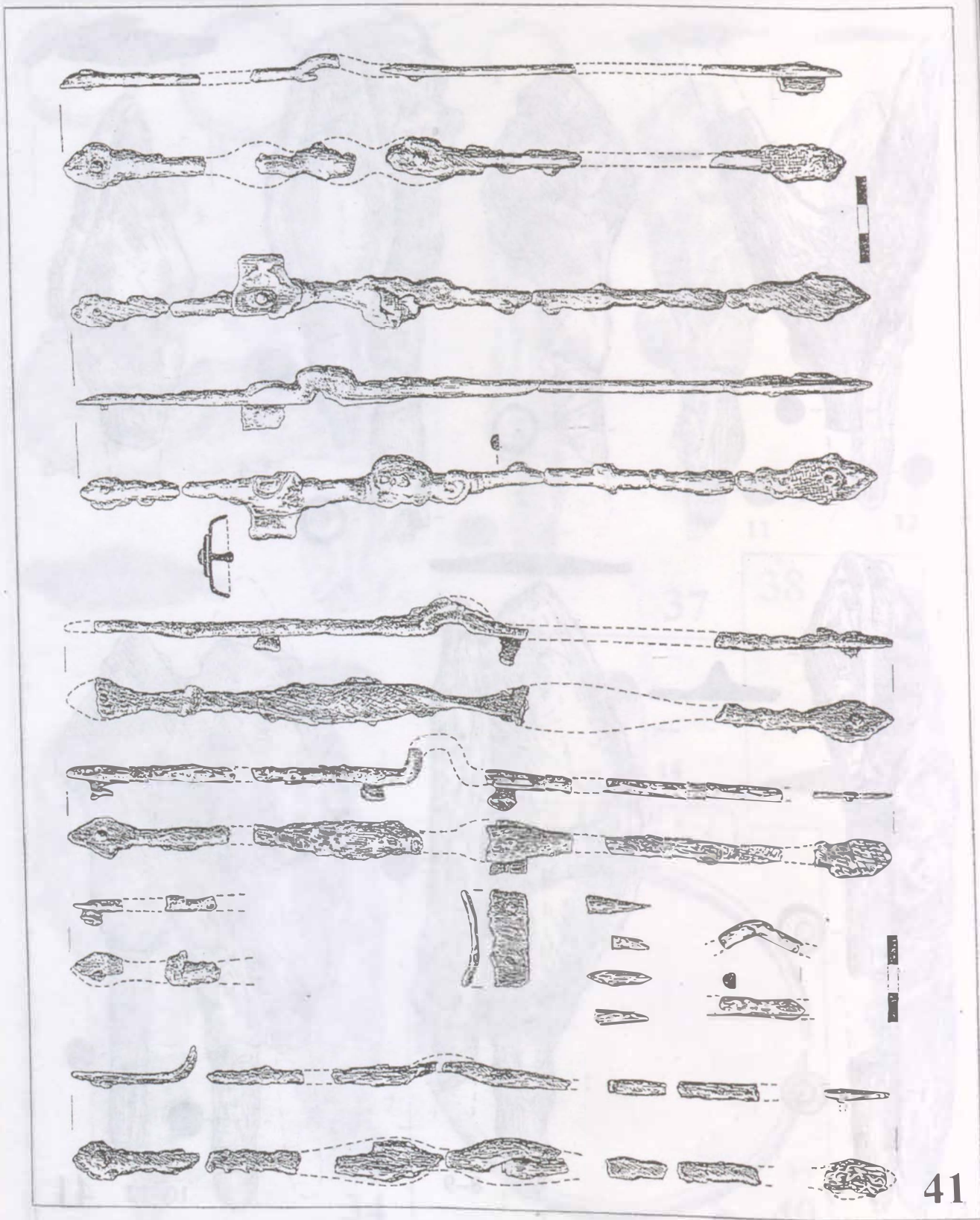

236. tábla: Sárrétudvari-Hízófold. 41. sír (1:2)

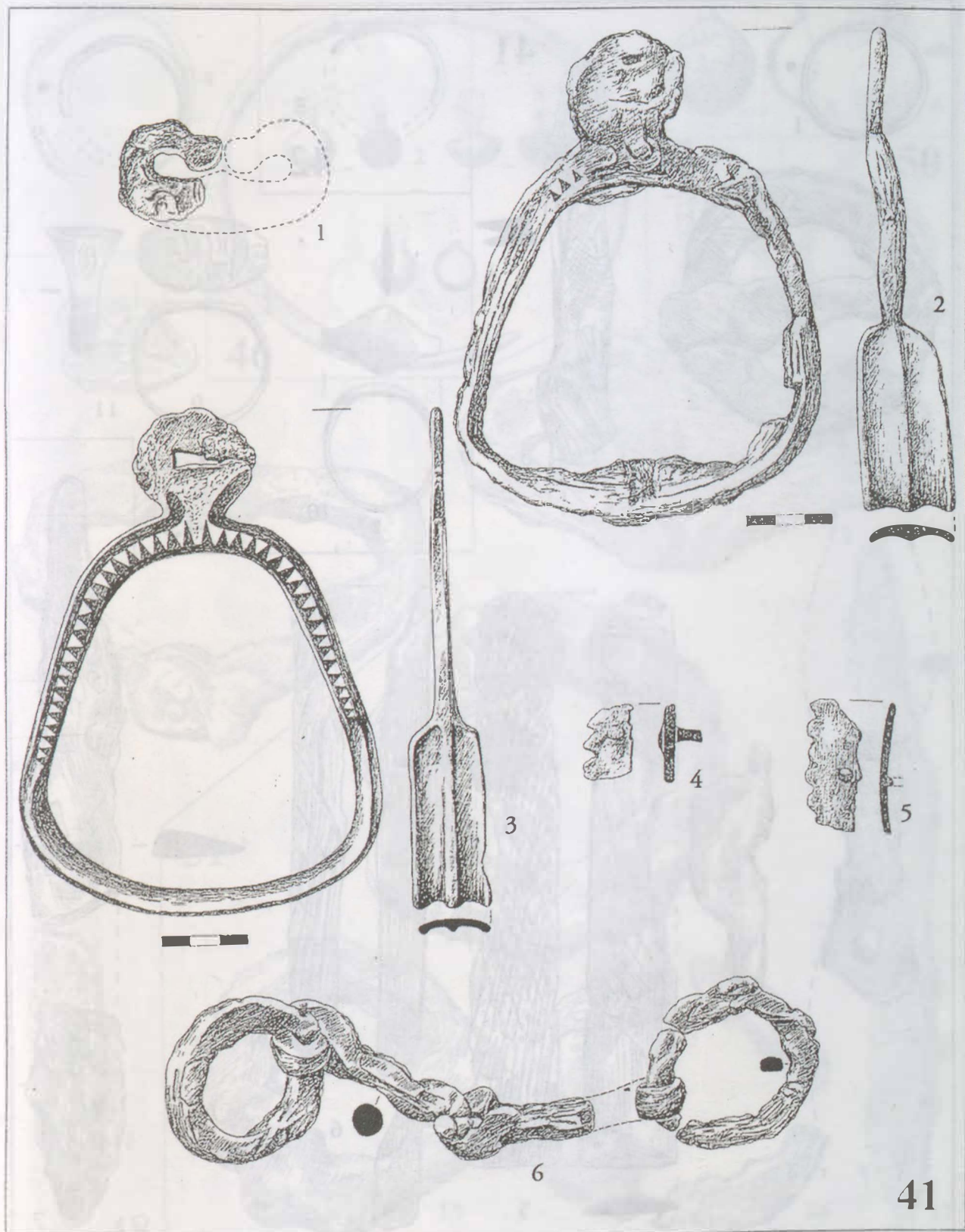

237. tábla: Sárrétudvari-Hízóföld. 41. sír (1:2)

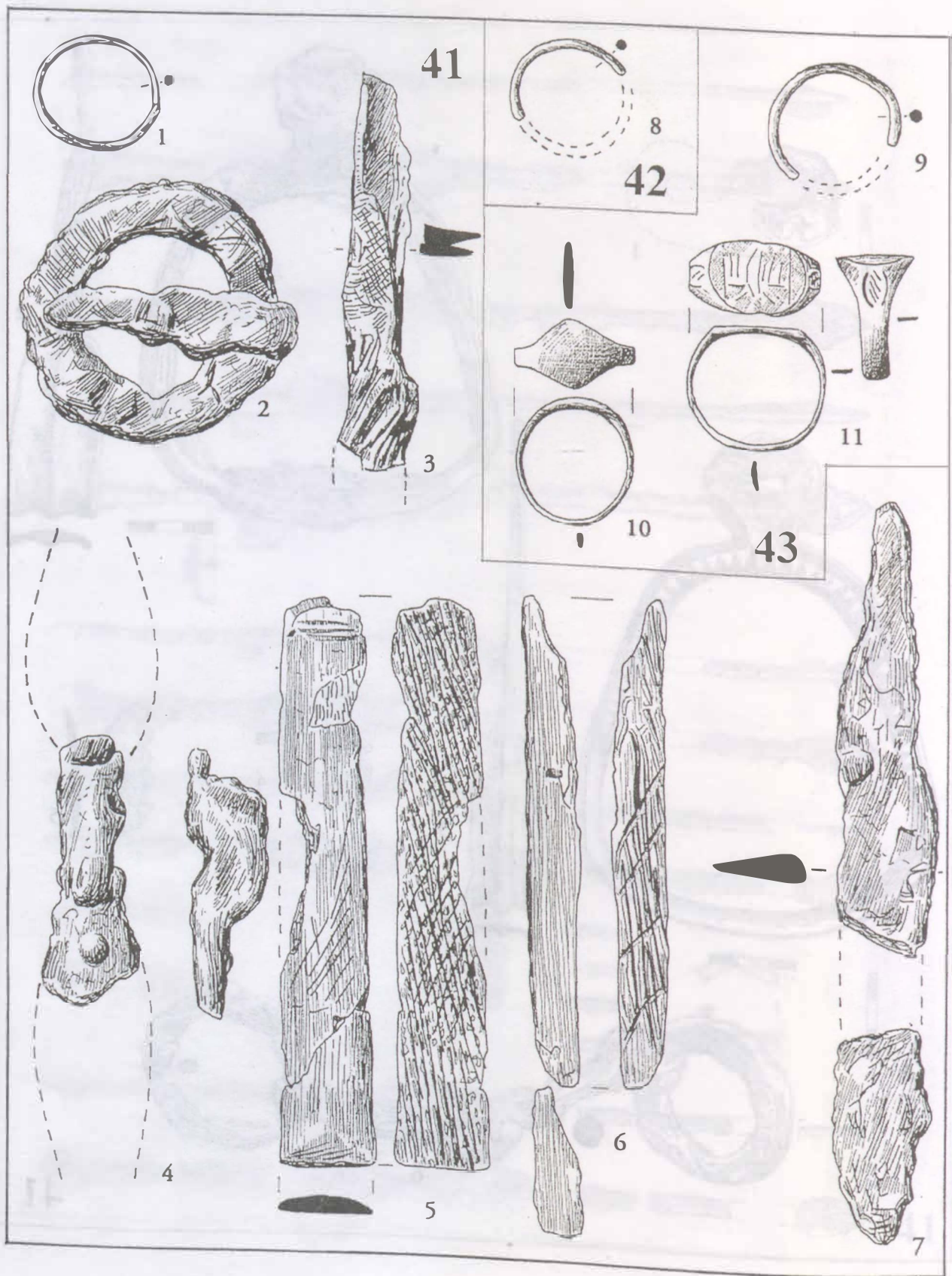

238. tábla: Sárrétudvari-Hízóföld. 41–43. sír (1:1)

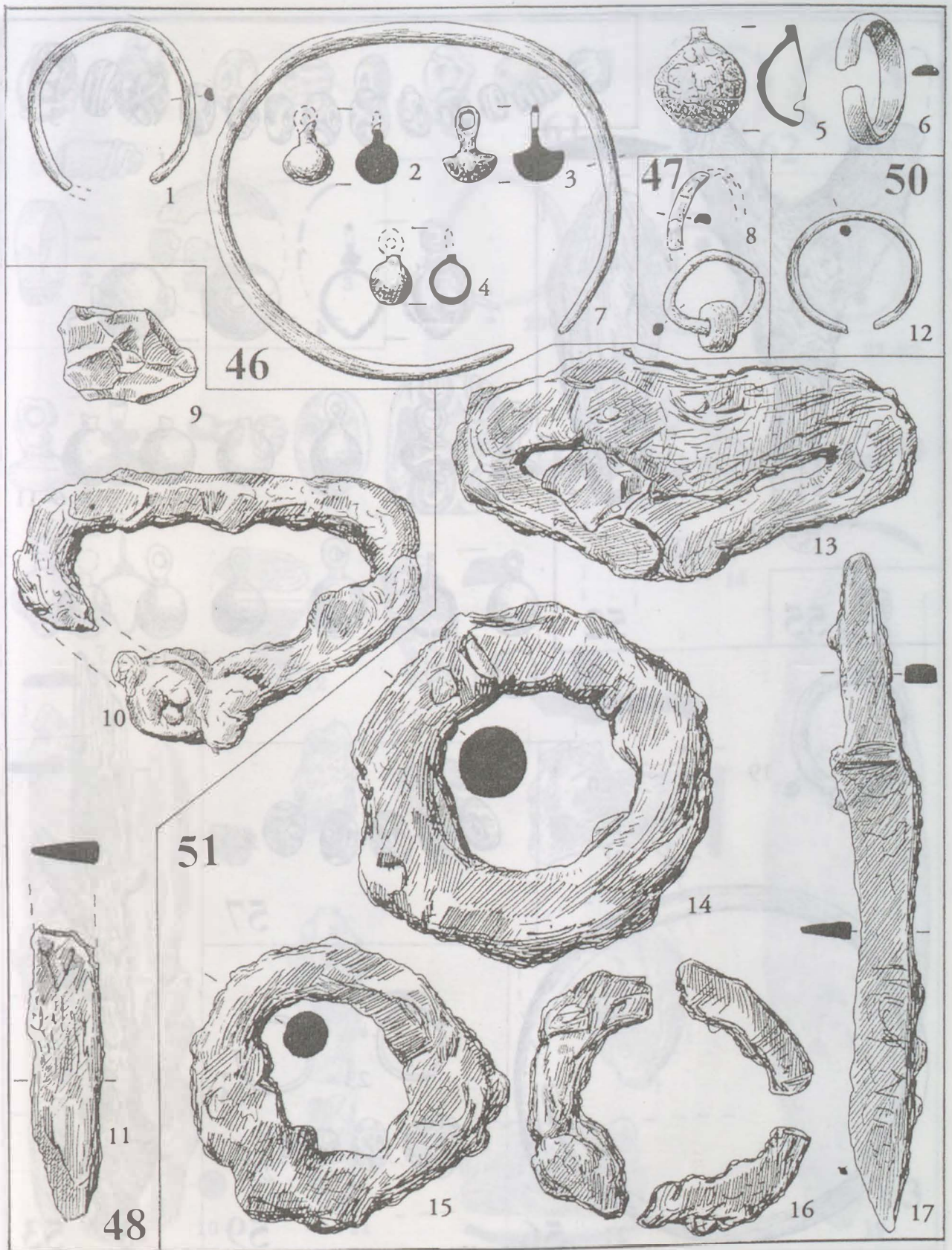

239. tábla: Sárrétudvari-Hízóföld. 46-48., 50-51. sír (1:1)

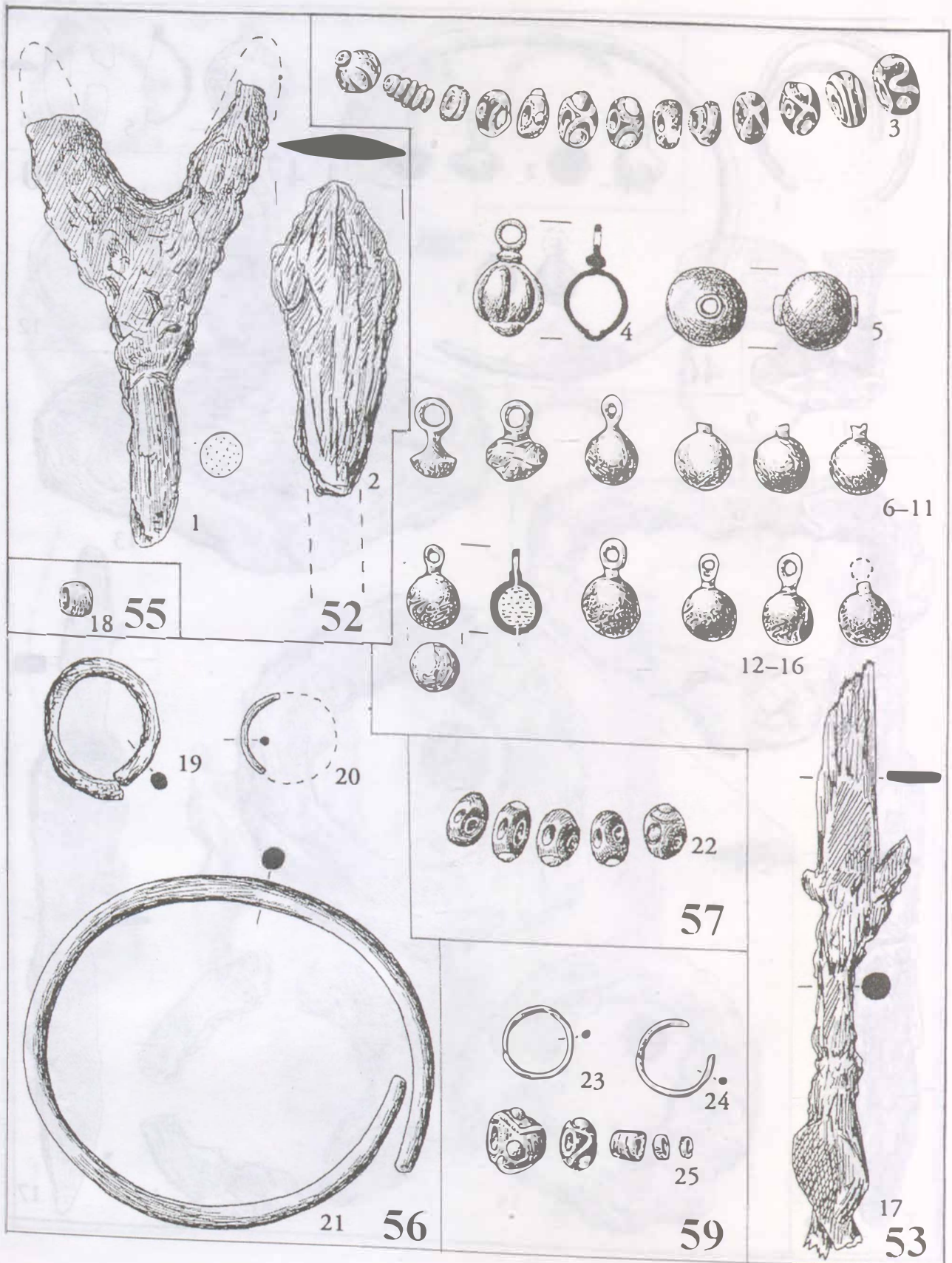

240. tábla: Sárrétudvari-Hízófold. 52-53., 55-57., 59. sír (1:1)

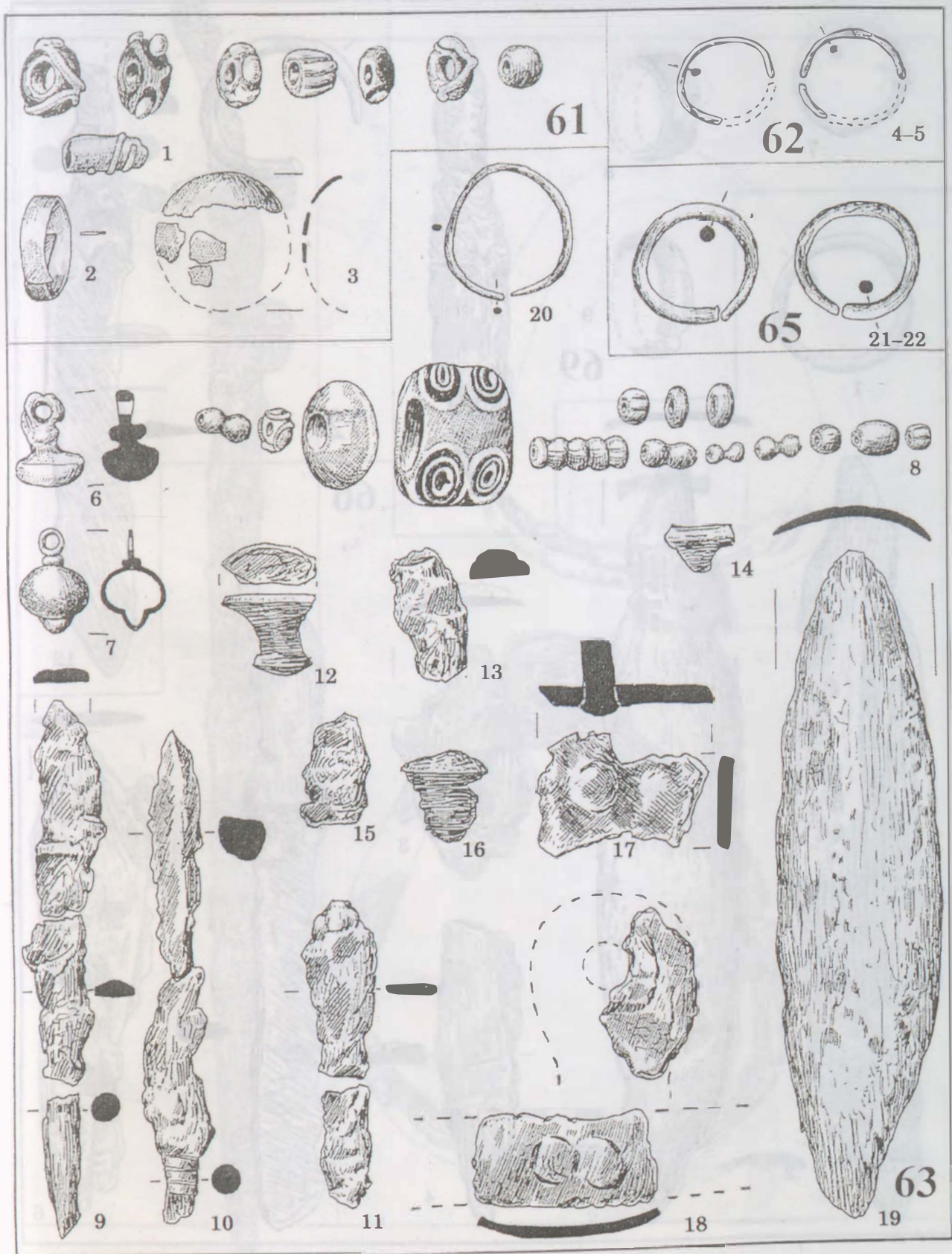

241. tábla: Sárrétudvari-Hízóföld. 61-63., 65. sír (1:1)

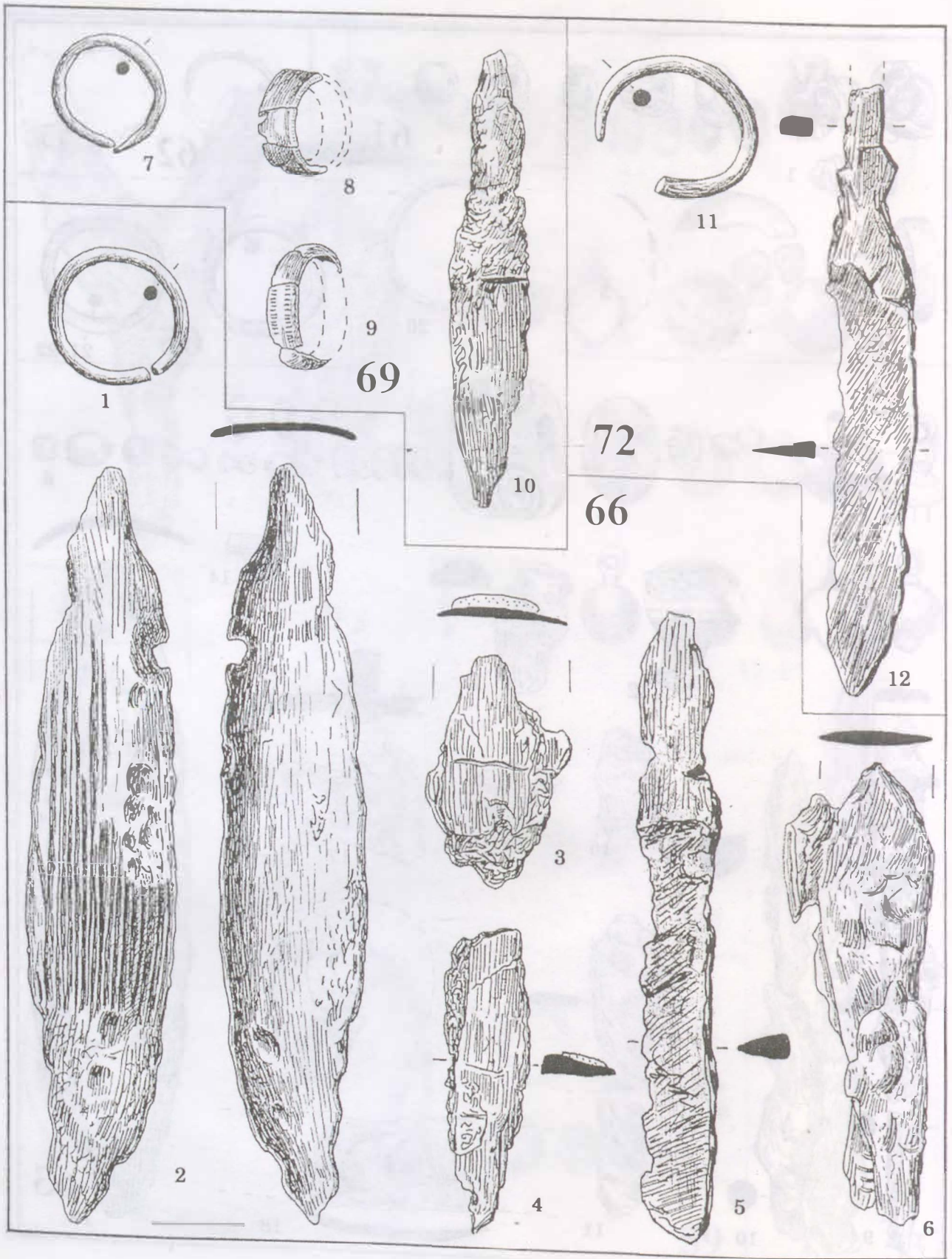

242. tábla: Sárrétudvari-Hízófold. 66., 69., 72. sír (1:1)

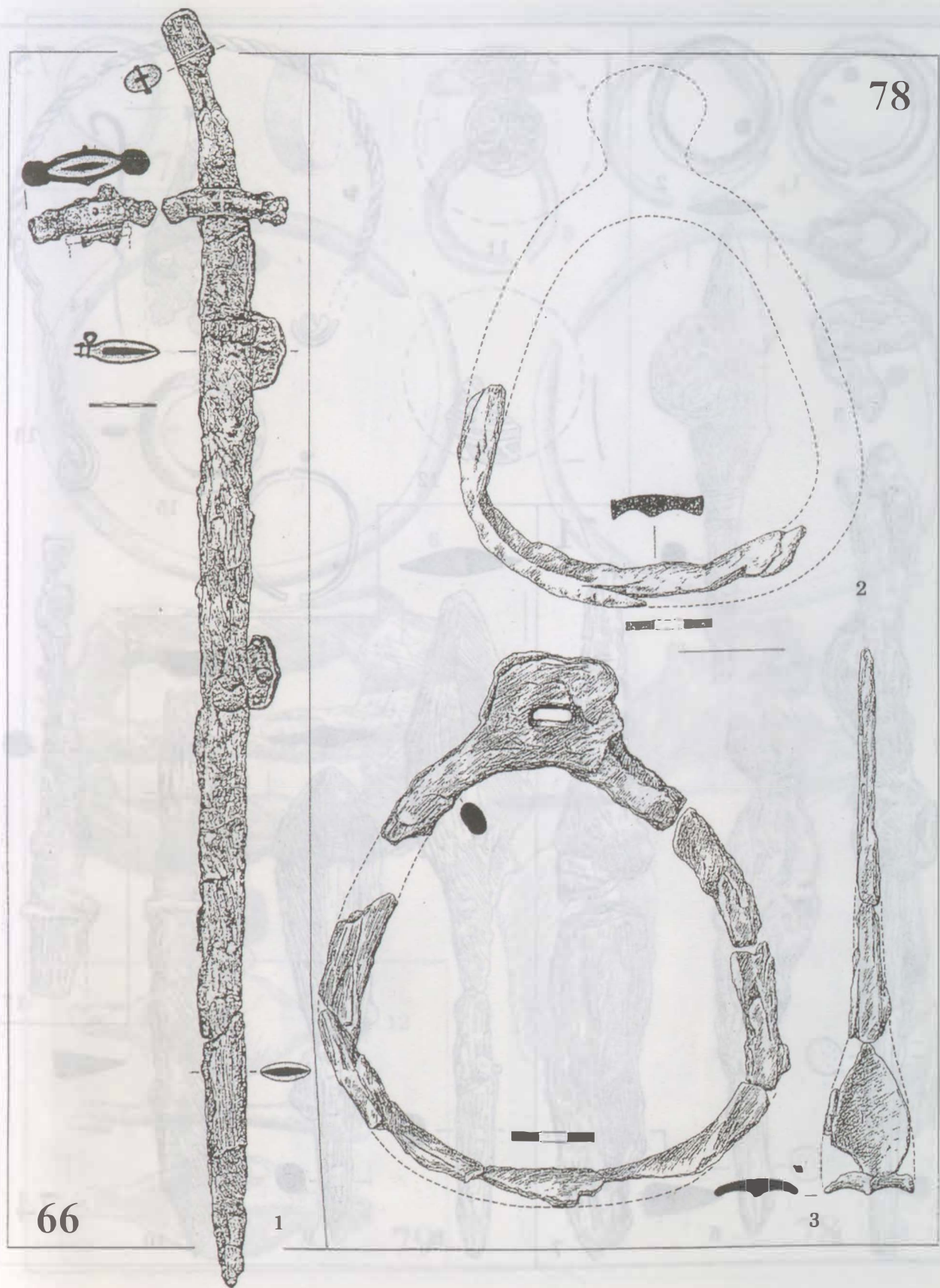

243. tábla: Sárrétudvari-Hízóföld. 66. sír (kb. 1:4) és 78. sír (1:2)

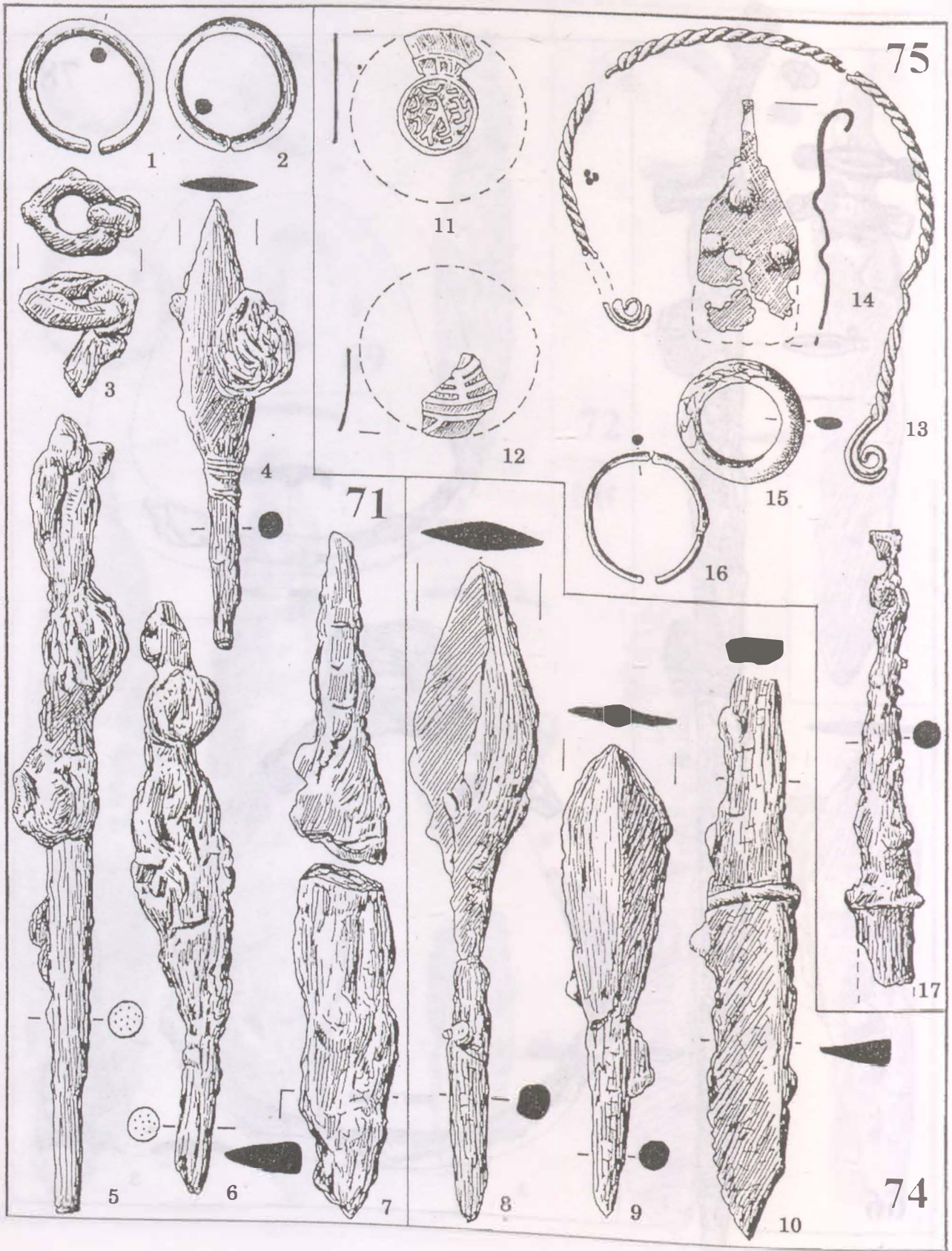

244. tábla: Sárrétudvari-Hízófold. 71., 74-75. sír (1:1)

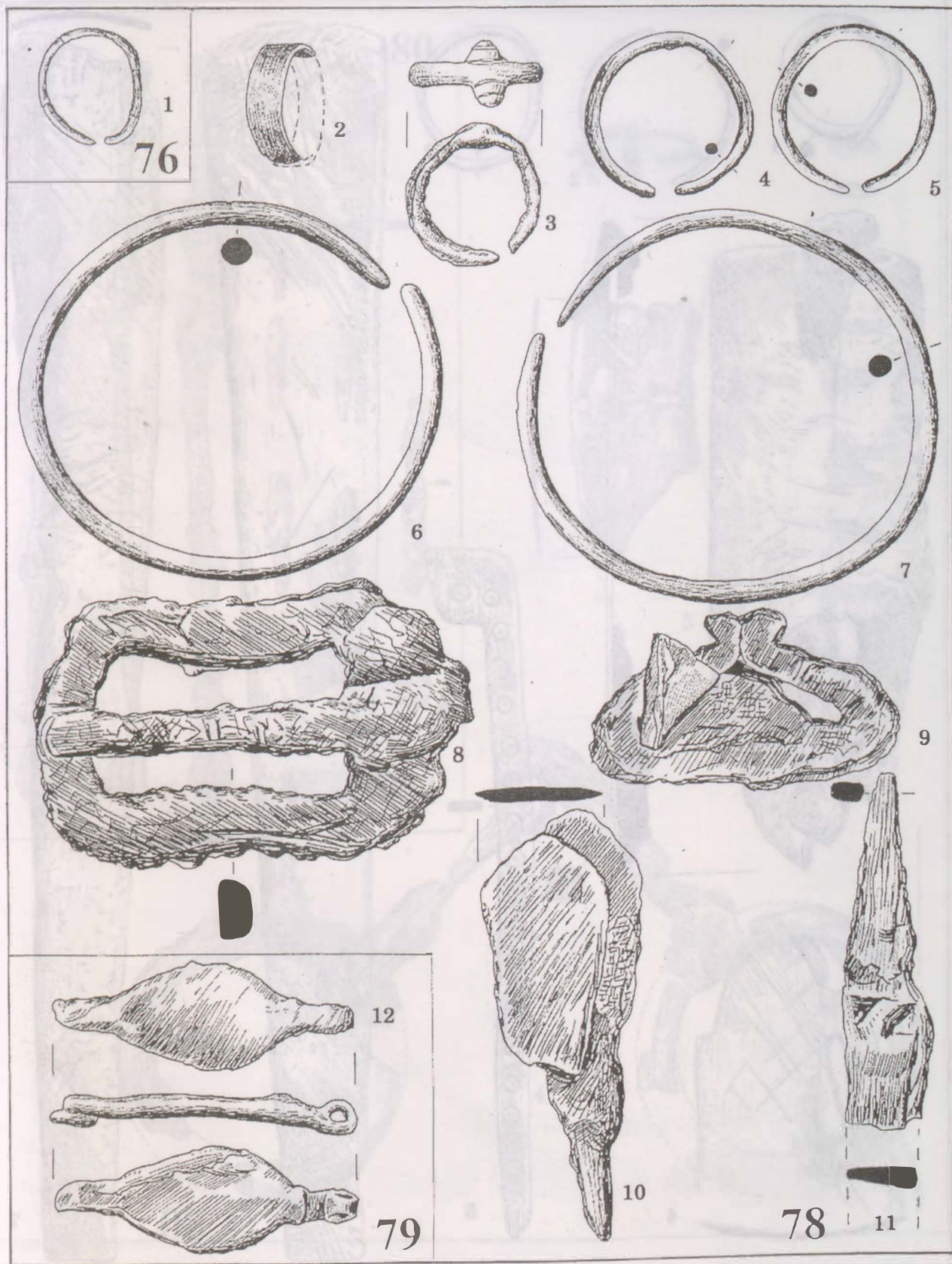

245. tábla: Sárrétudvari-Hízóföld. 76., 78., 79. sír (1:1)

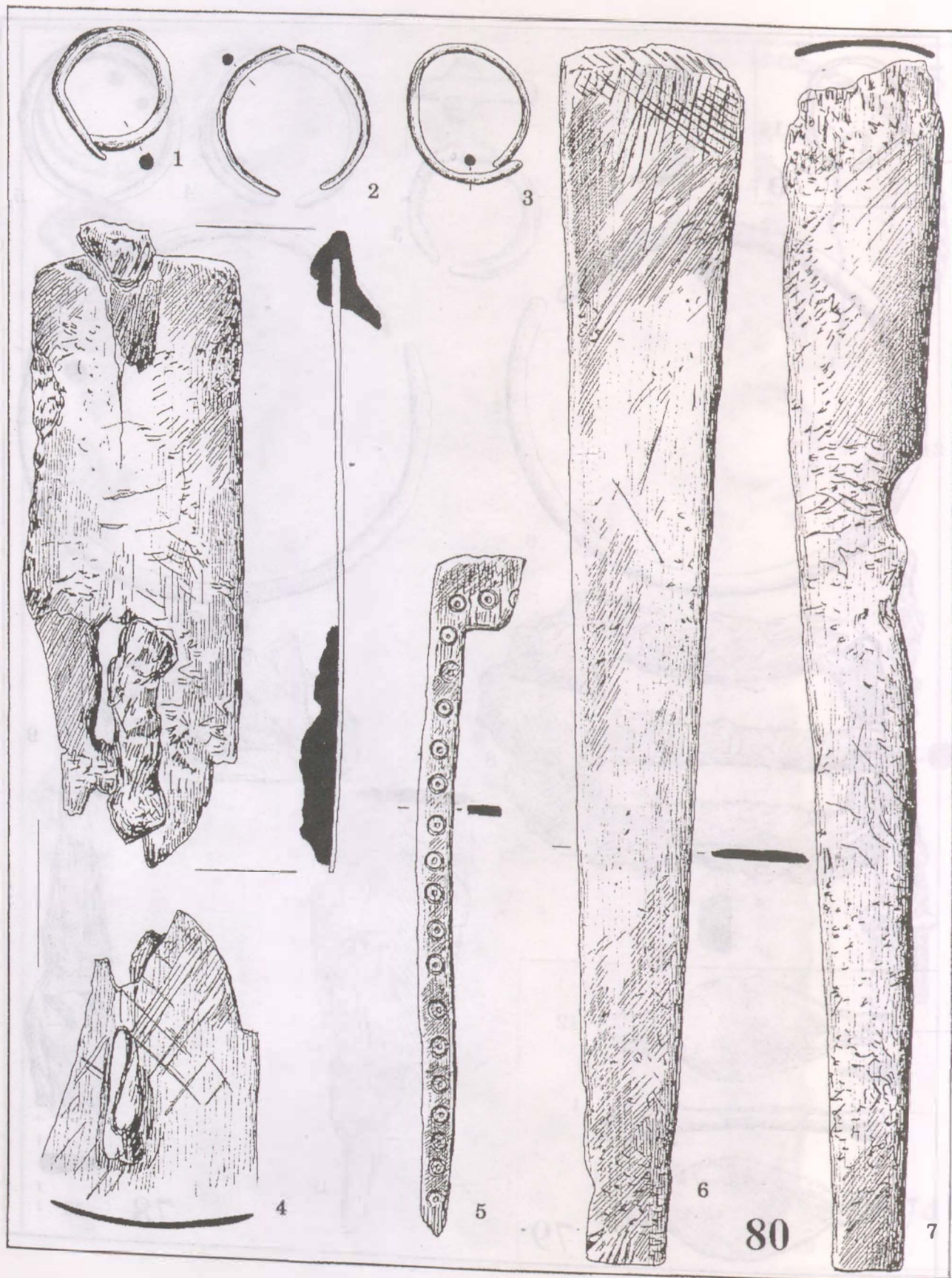

246. tábla: Sárrétudvari-Hízófold. 80. sír (1:1)

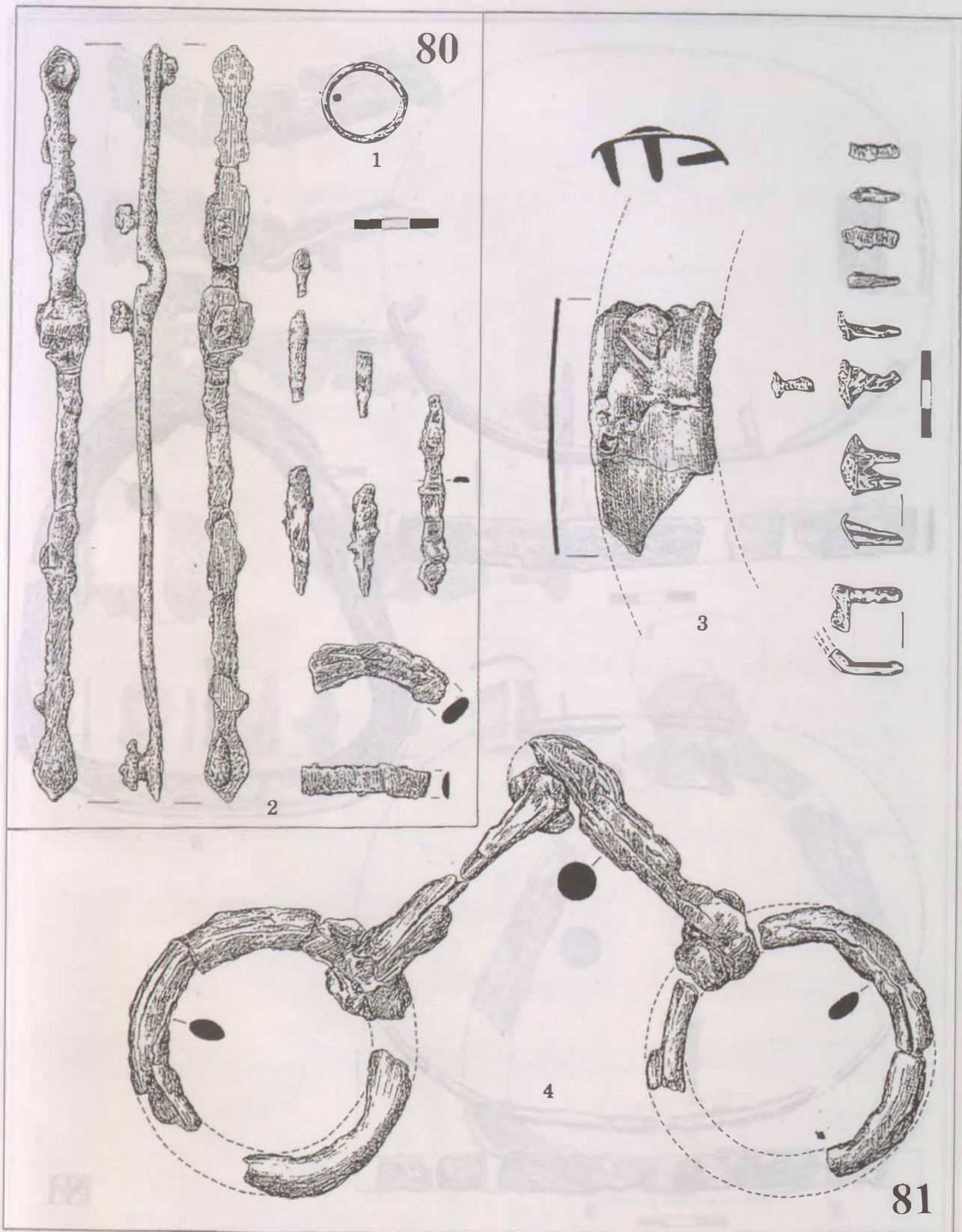

247. tábla: Sárrétudvari-Hízóföld. 80–81. sír (1:2)

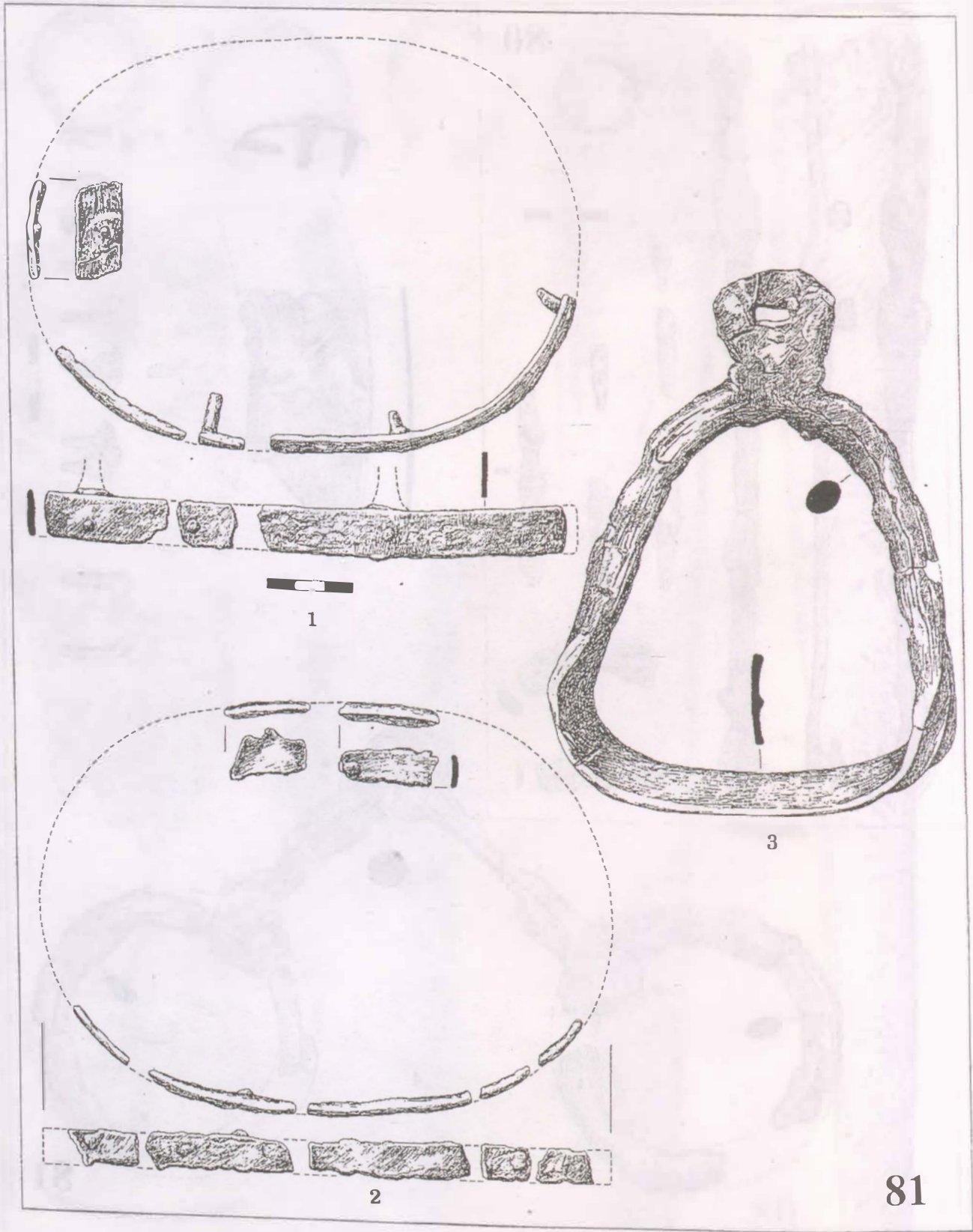

81

248. tábla: Sárrétudvari-Hízóöld. 81. sír (1:2)

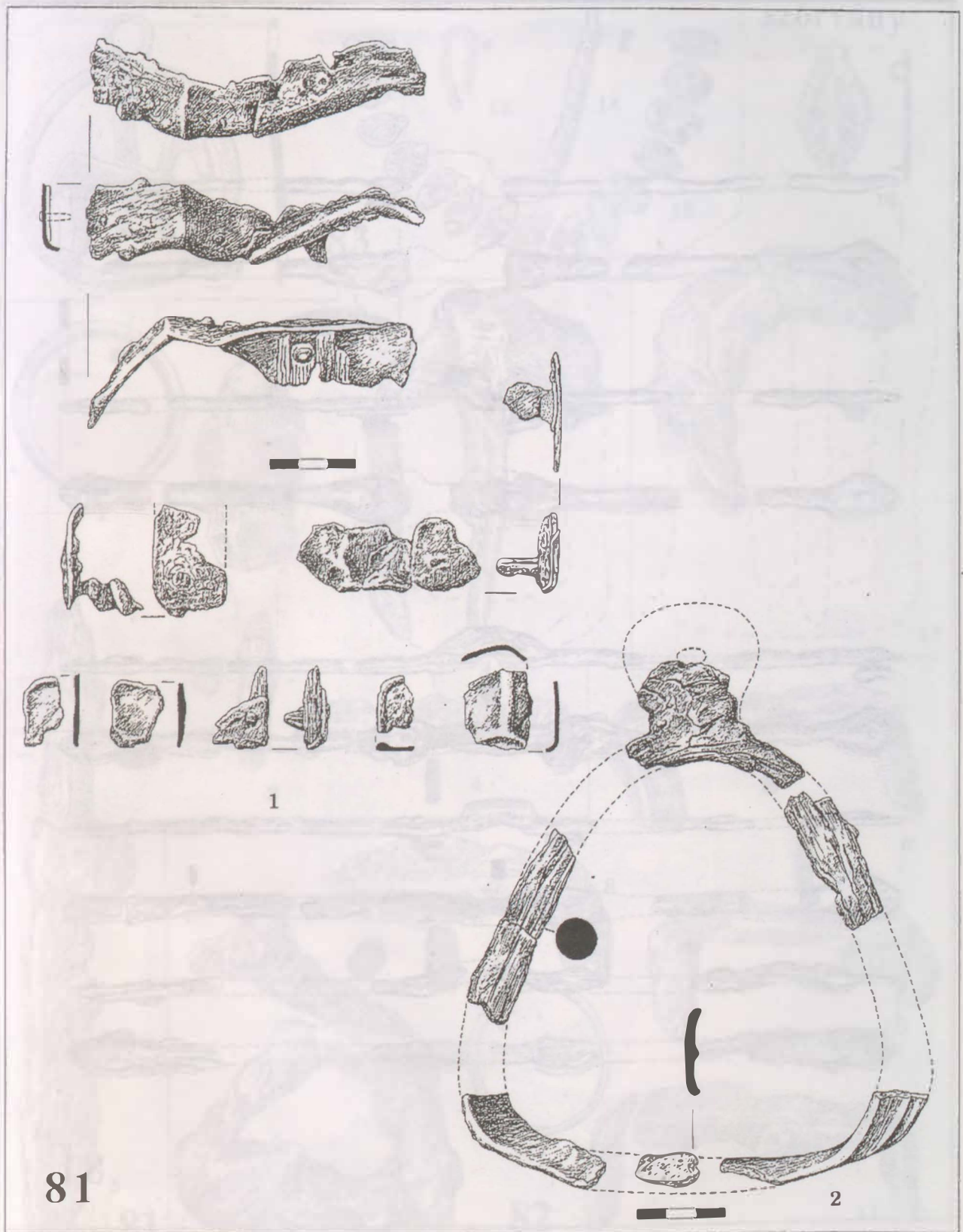

249. tábla: Sárrétudvari-Hízóöld. 81. sír (1:2)

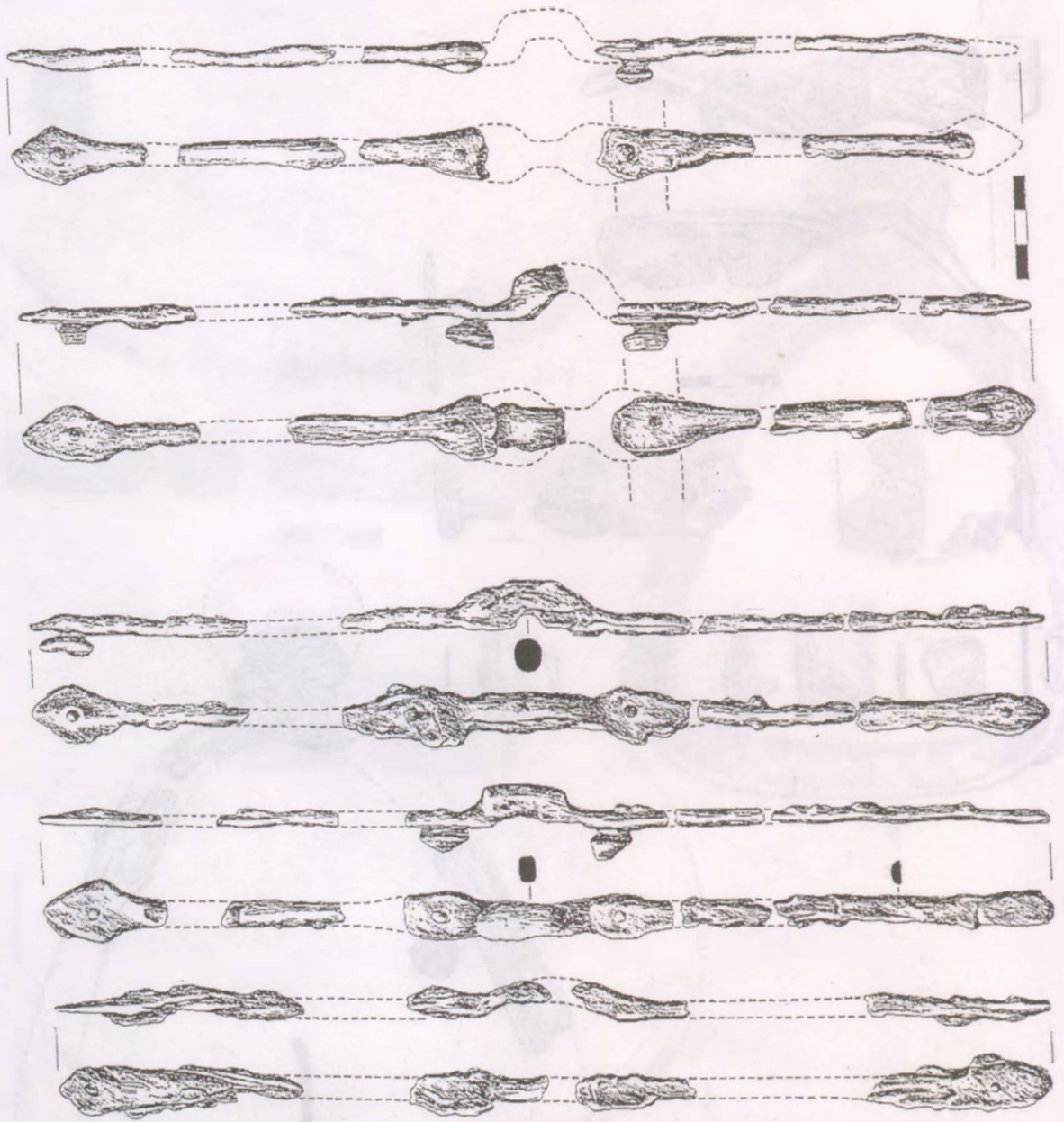

81

250. tábla: Sárrétudvari-Hízóföld. 81. sír (1:2)

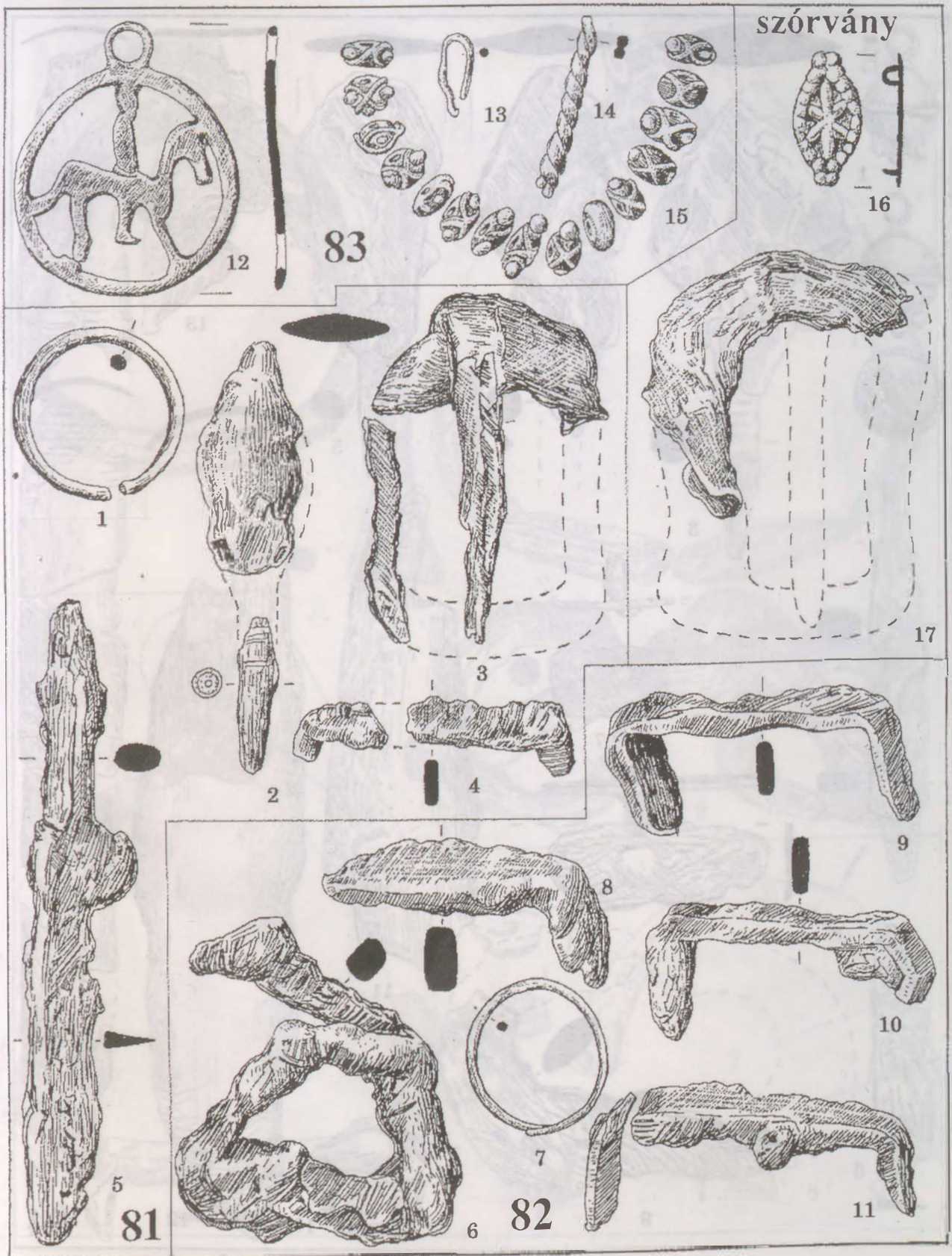

251. tábla: Sárrétudvari-Hízóföld. 81–83. sír és szórvány (1:1)

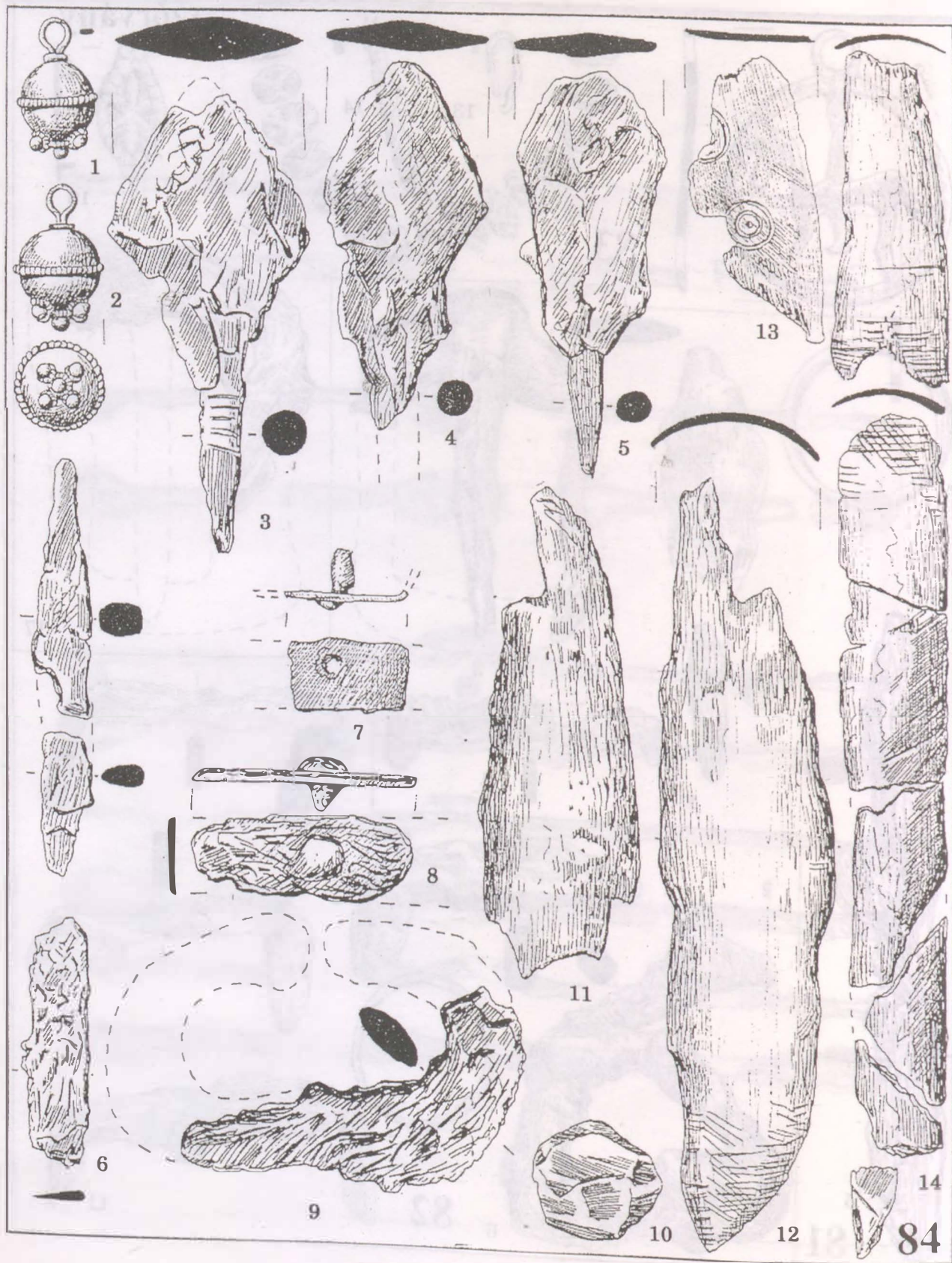

252. tábla: Sárrétudvari-Hízófold. 84. sír (1:1)

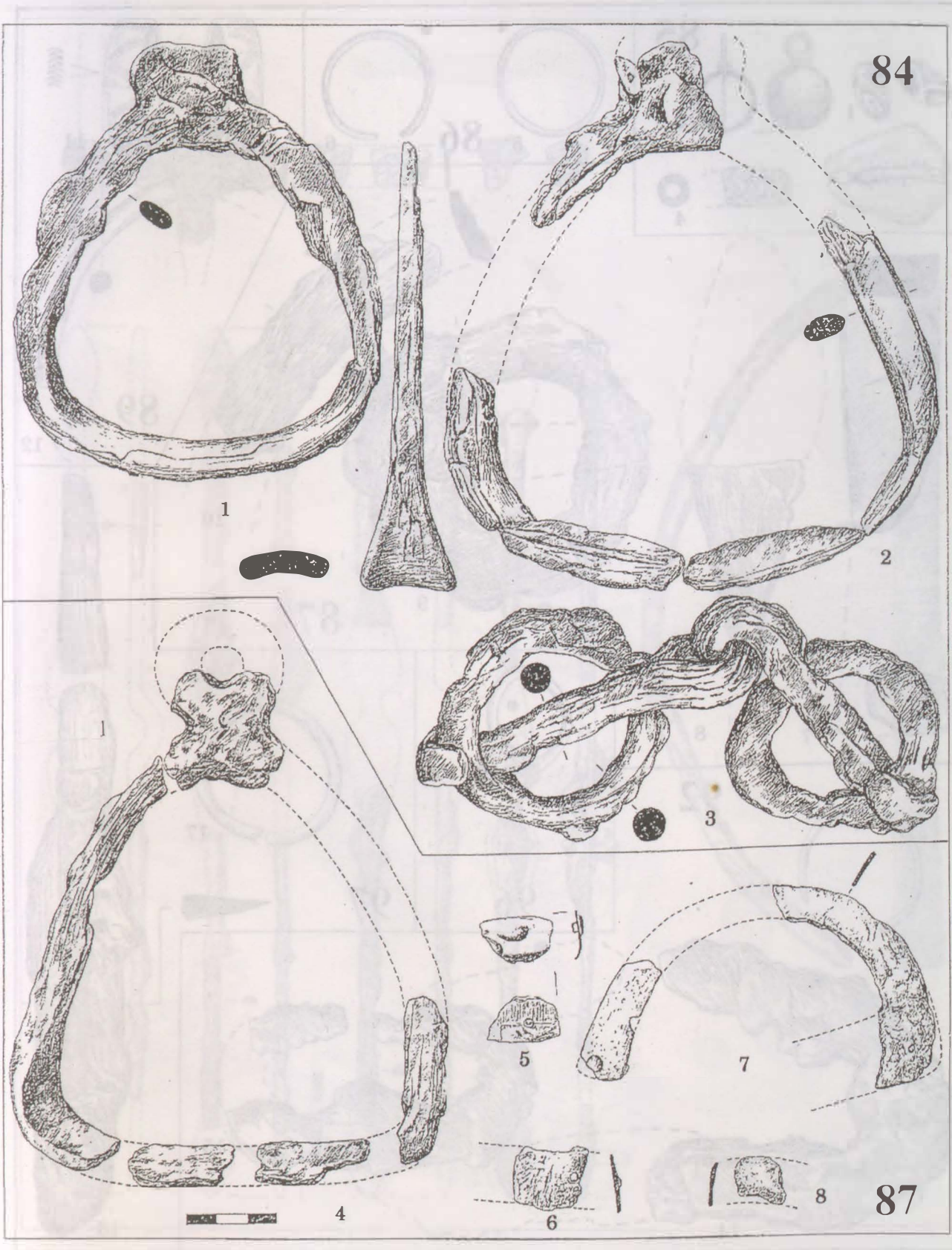

253. tábla: Sárrétudvari-Hízóföld. 84., 87. sír (1:2)

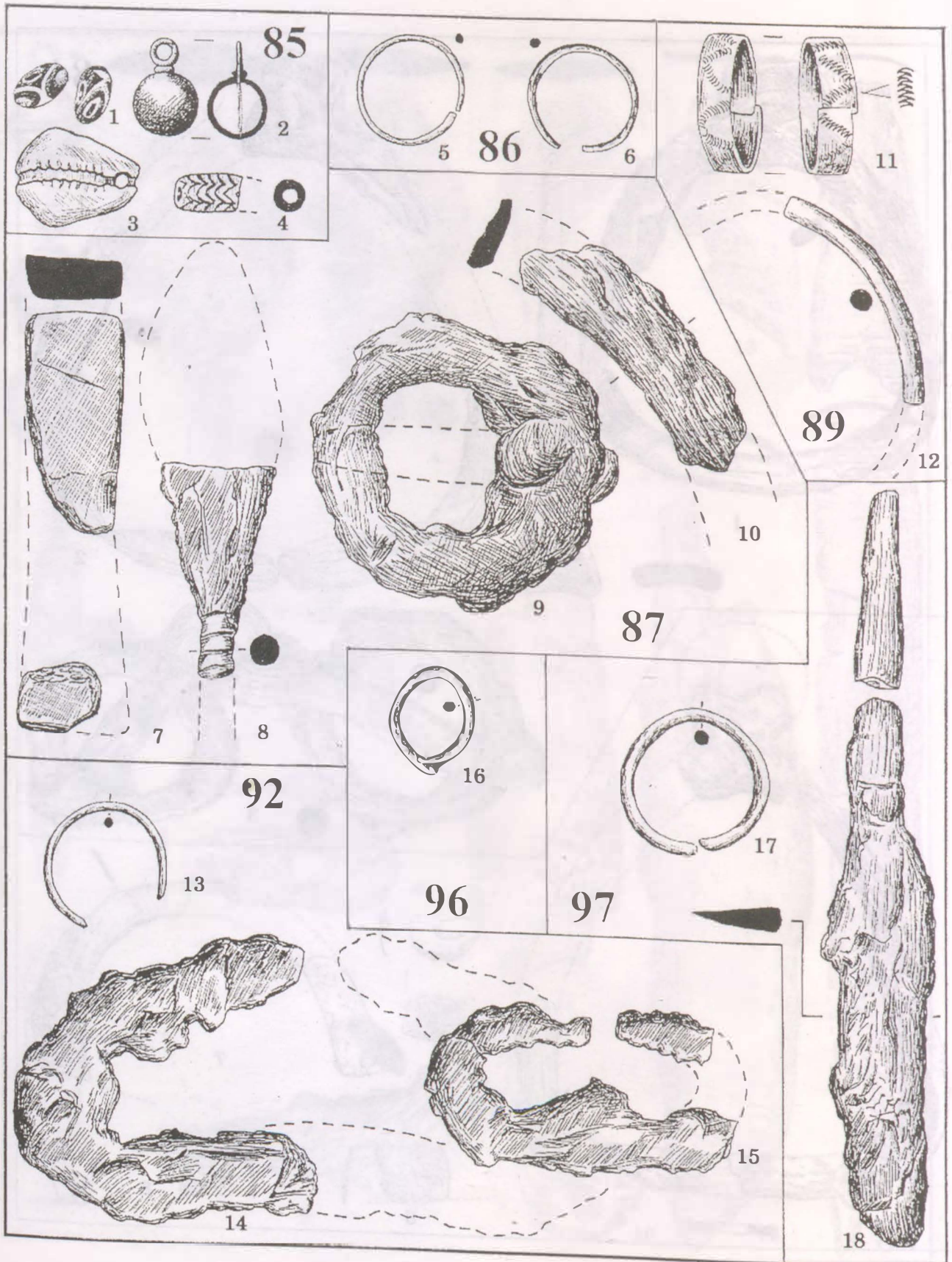

254. tábla: Sárretudvari-Hízófold. 85-87., 89., 92., 96-97. sír (1:1)

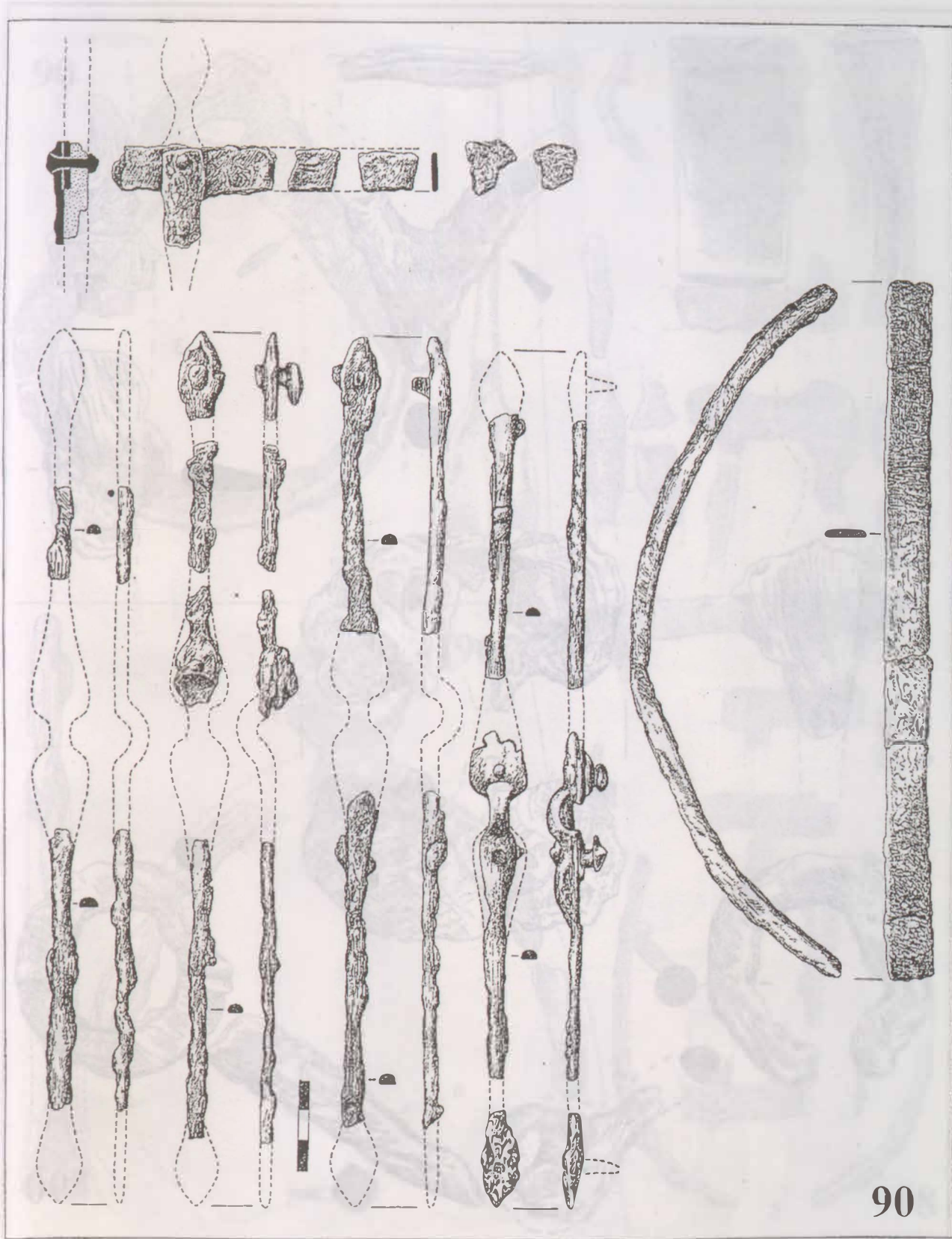

90

255. tábla: Sárrétudvari-Hízóföld. 90. sír (1:2)

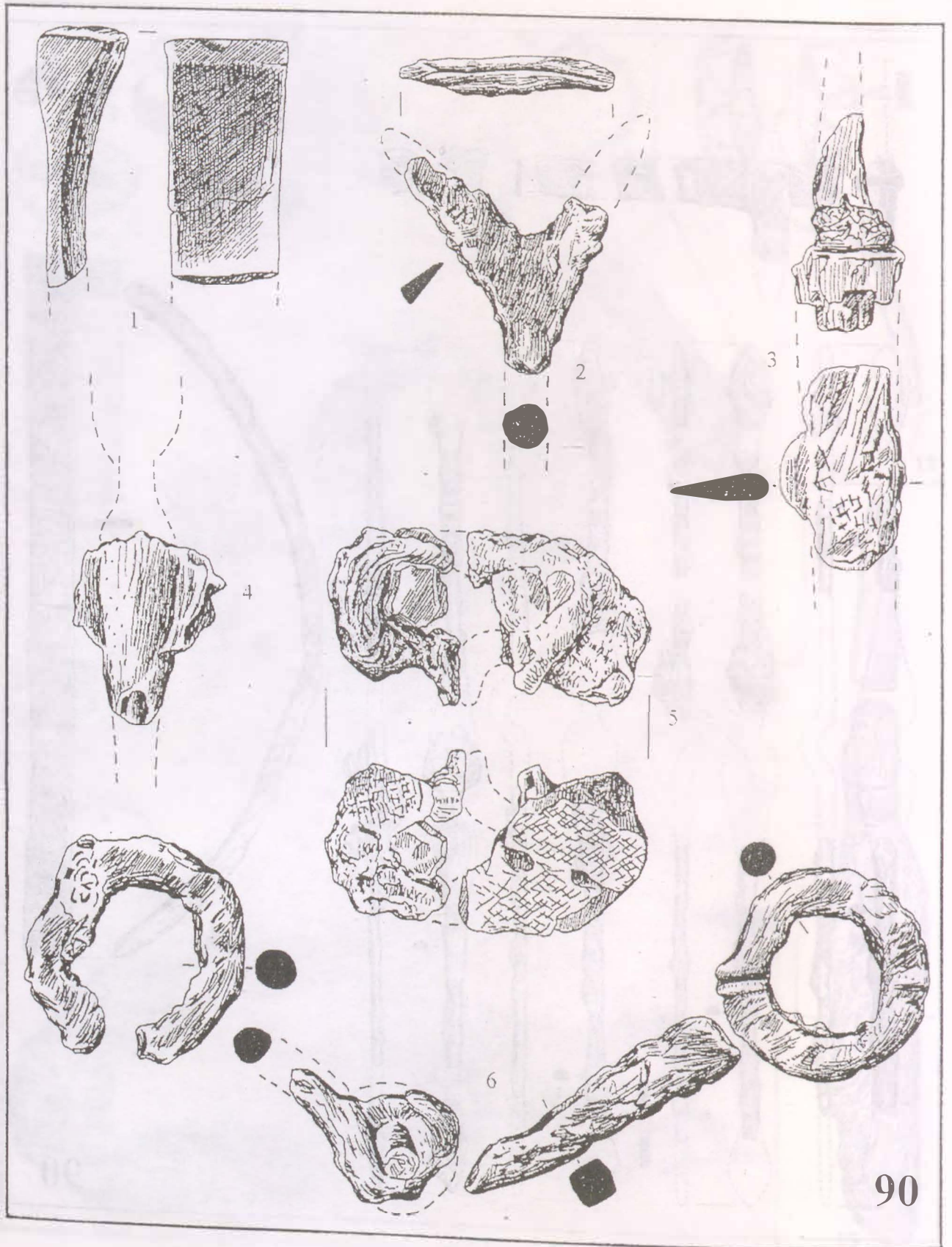

256. tábla: Sárrétudvari-Hízófold. 90. sír (1:1)

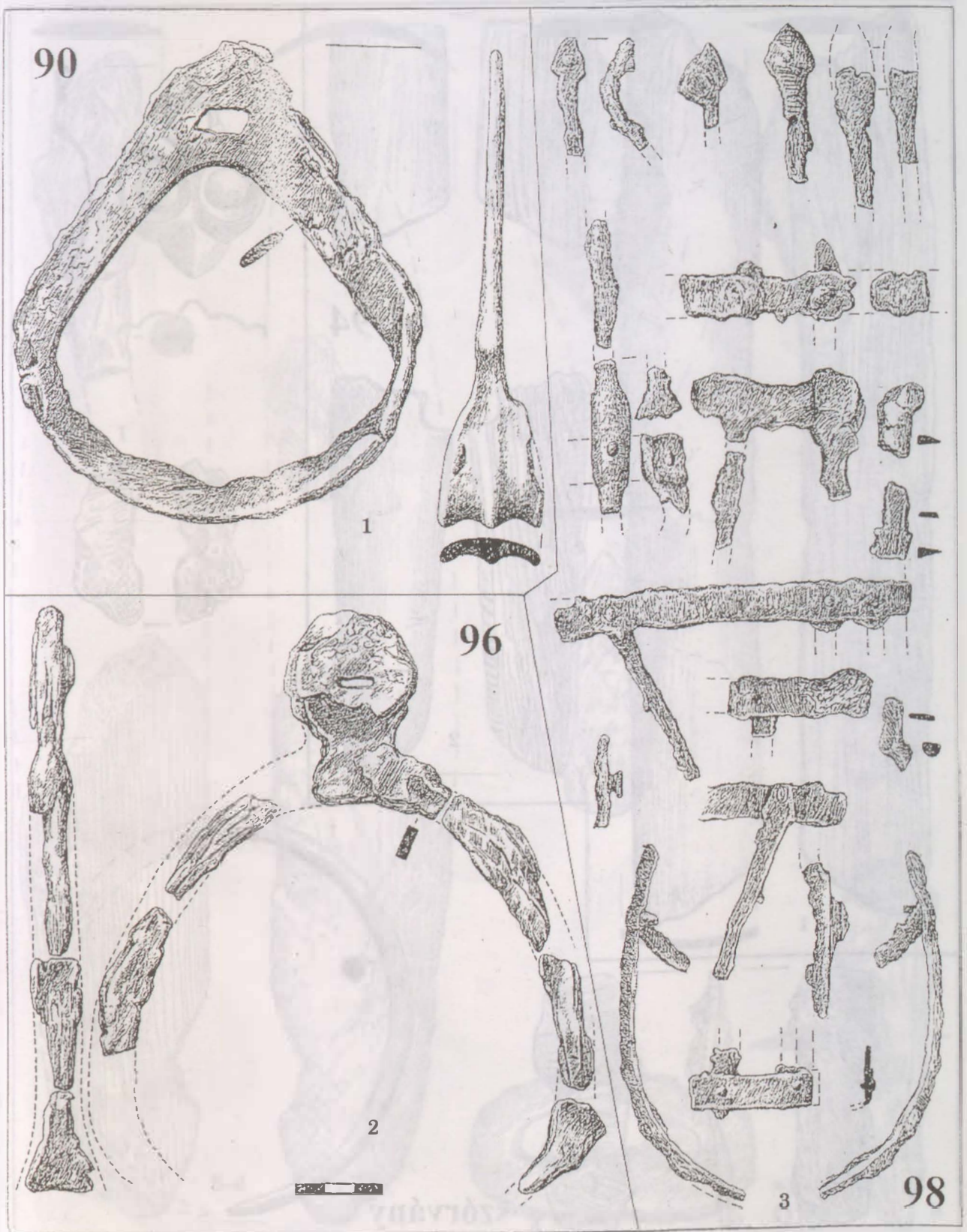

257. tábla: Sárrétudvari-Hízófold. 90., 96., 98. sír (1:2)

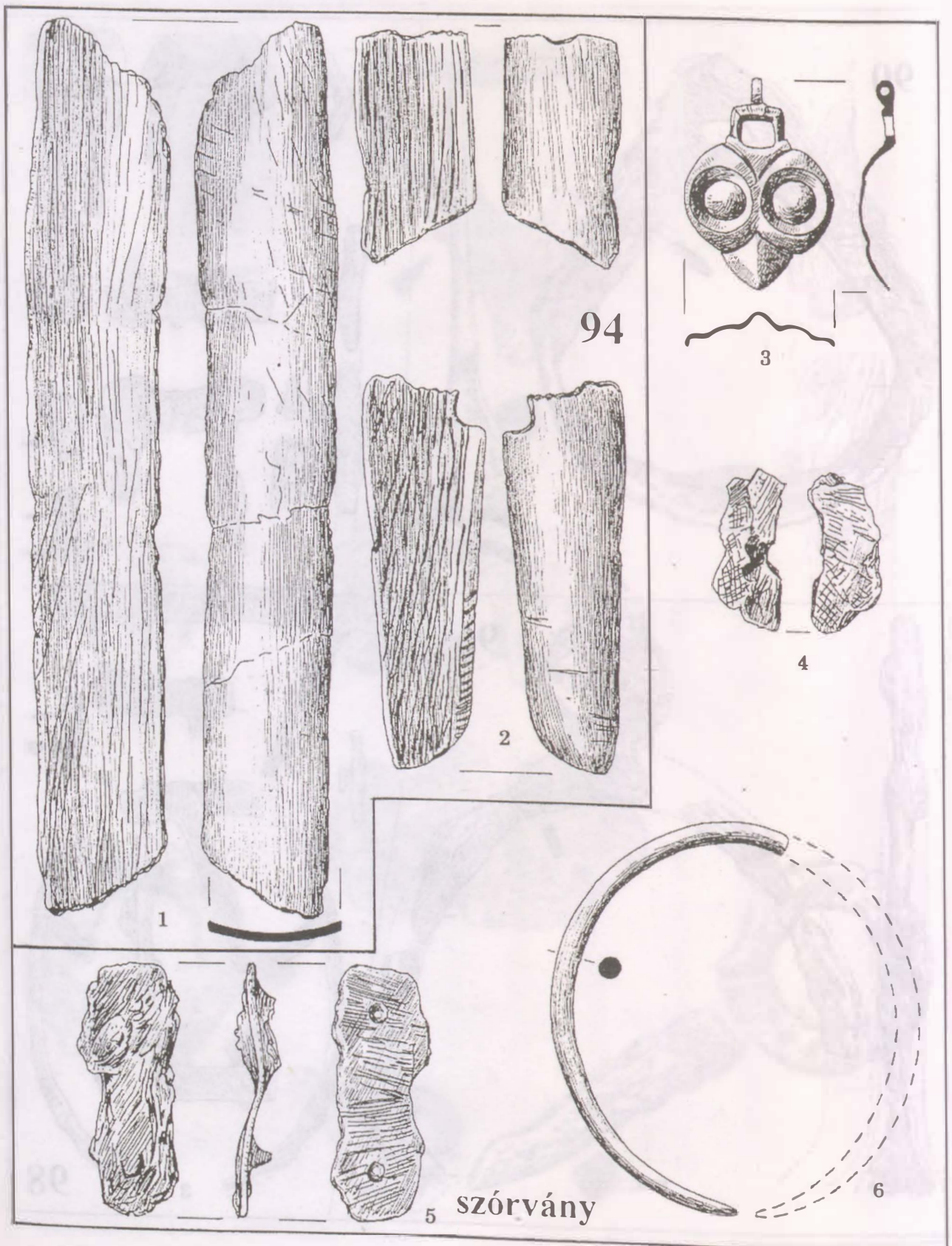

258. tábla: Sárrétudvari-Hízóföld. 94. sír és szórvány (1:1)

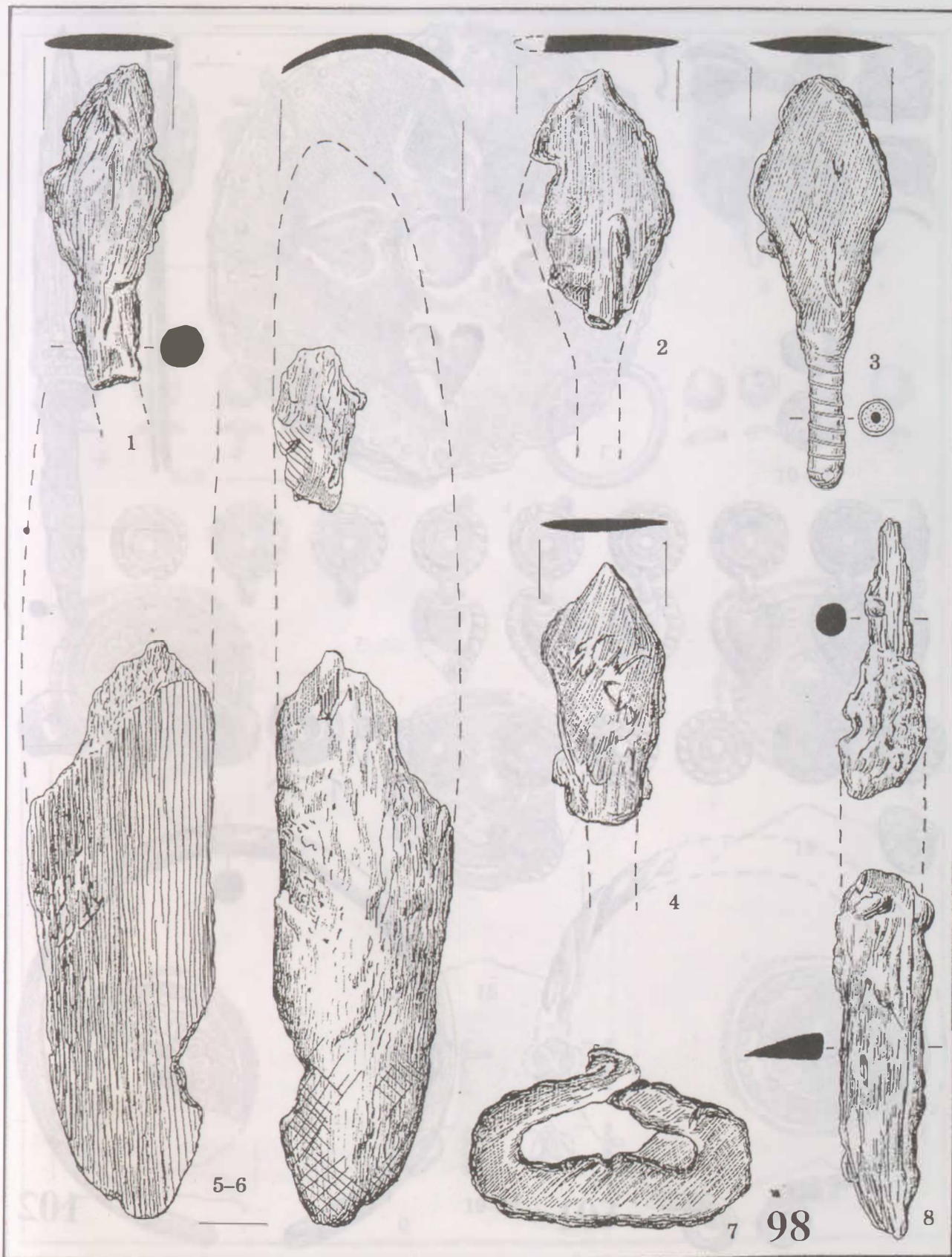

259. tábla: Sárrétudvari-Hízóföld. 98. sír (1:1)

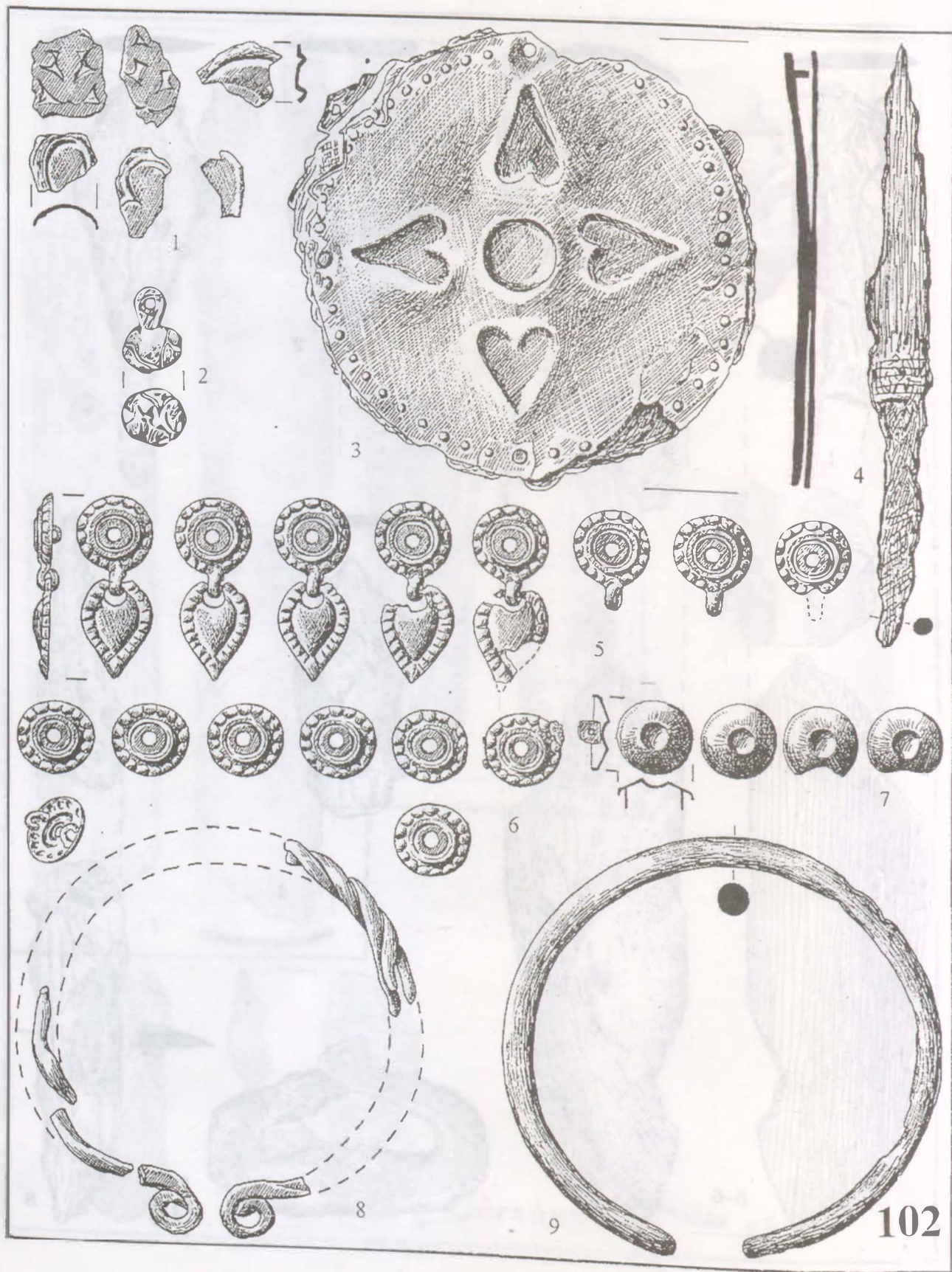

260. tábla: Sárretudvari-Hízófold. 102. sír (1:1)

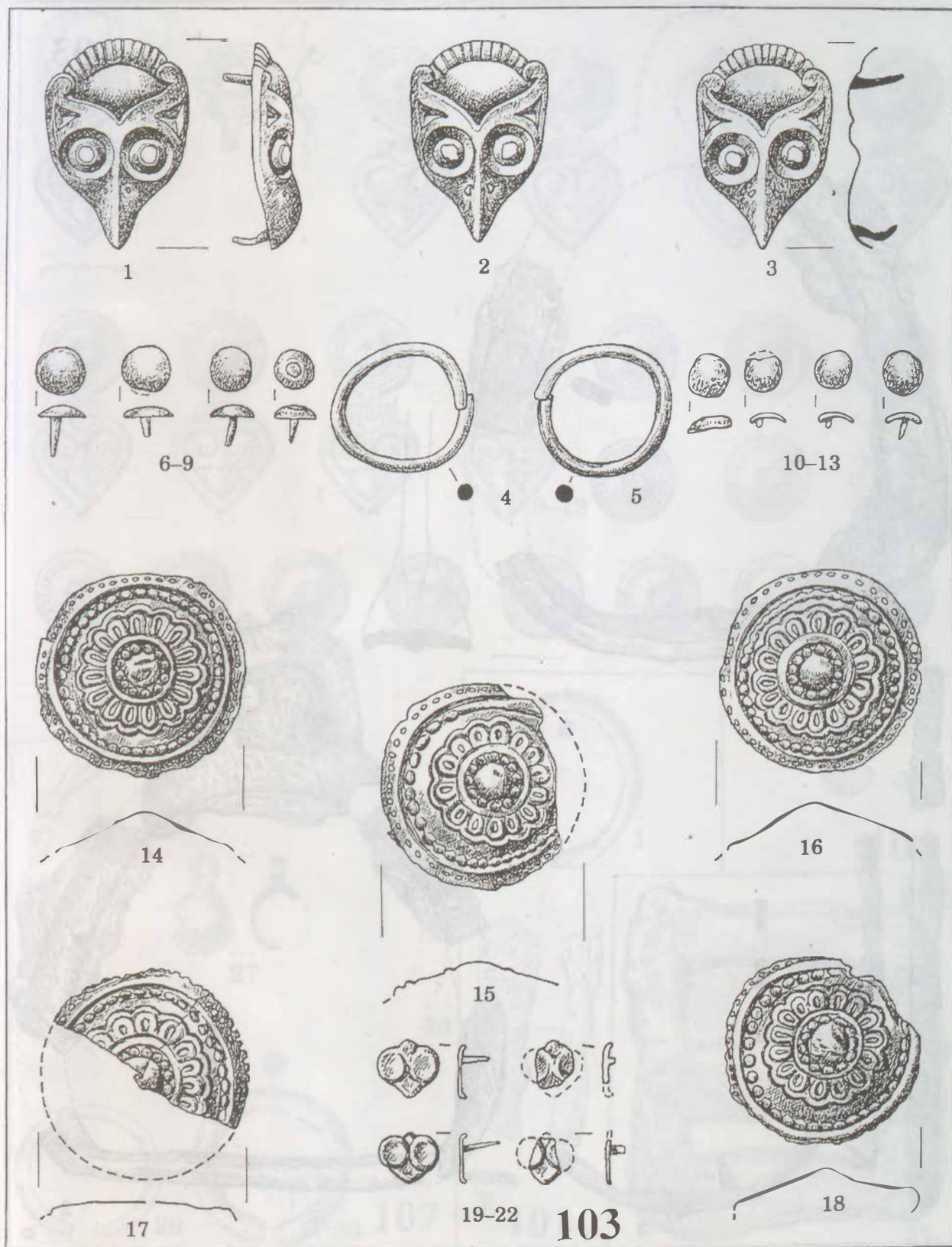

261. tábla: Sárrétudvari-Hízófold. 103. sír (1:1)

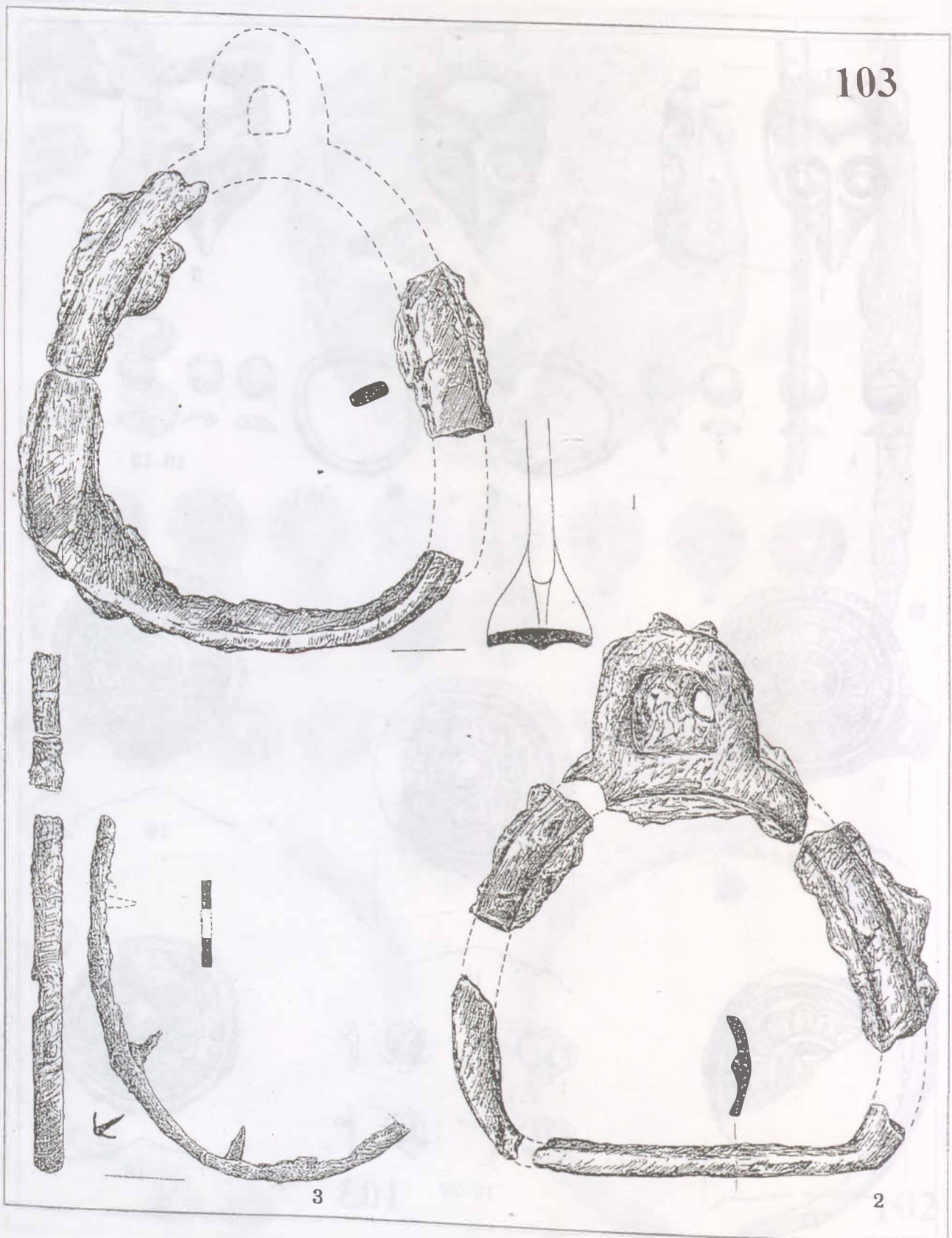

262. tábla: Sárrétudvari-Hizóföld. 103. sír (1:2)

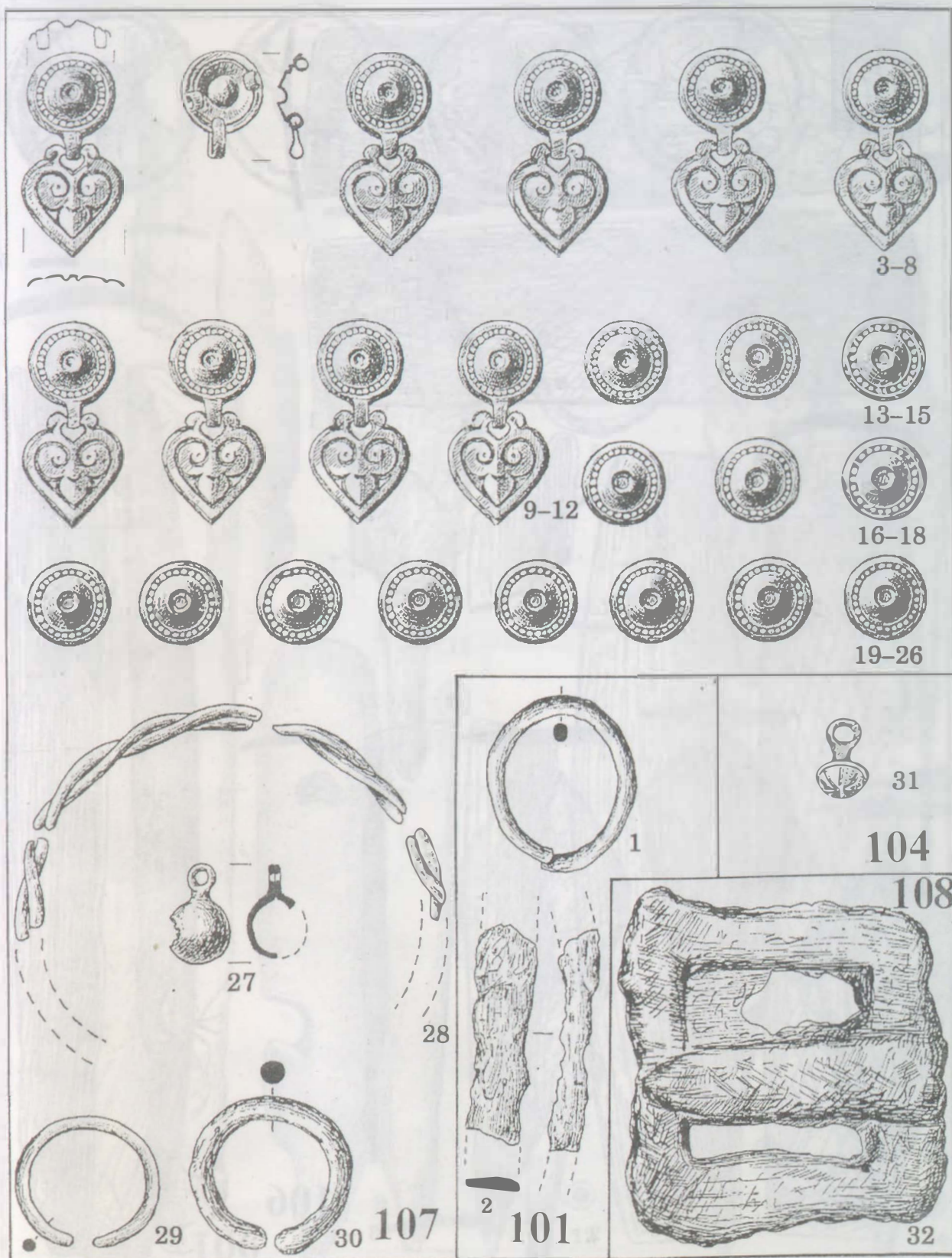

263. tábla: Sárrétudvari-Hízófold. 101., 104., 107-108. sír (1:1)

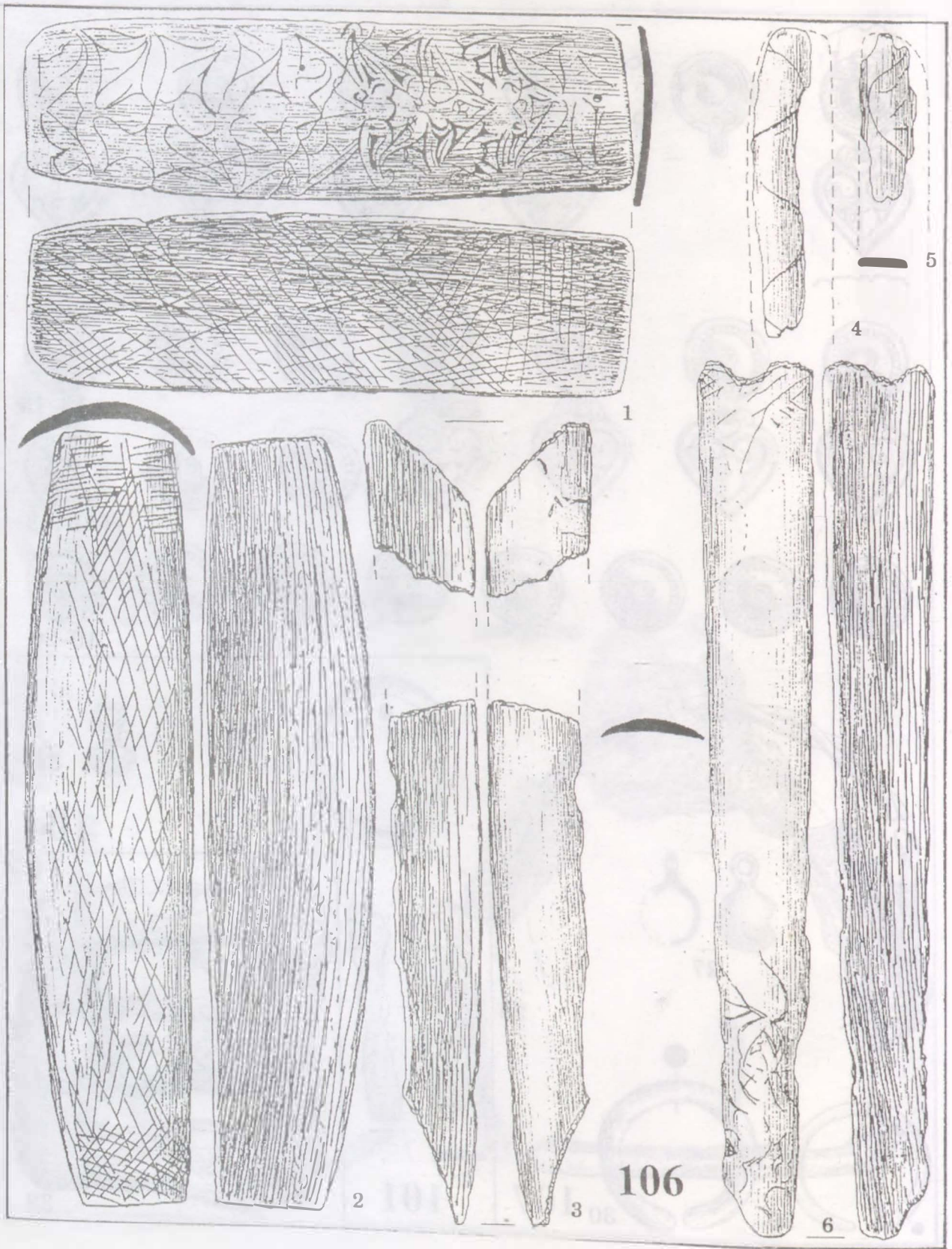

264. tábla: Sárrétudvari-Hízóföld. 106. sír (1:1)



265. tábla: Sárrétudvari-Hízófold. 106. sír (1:1)

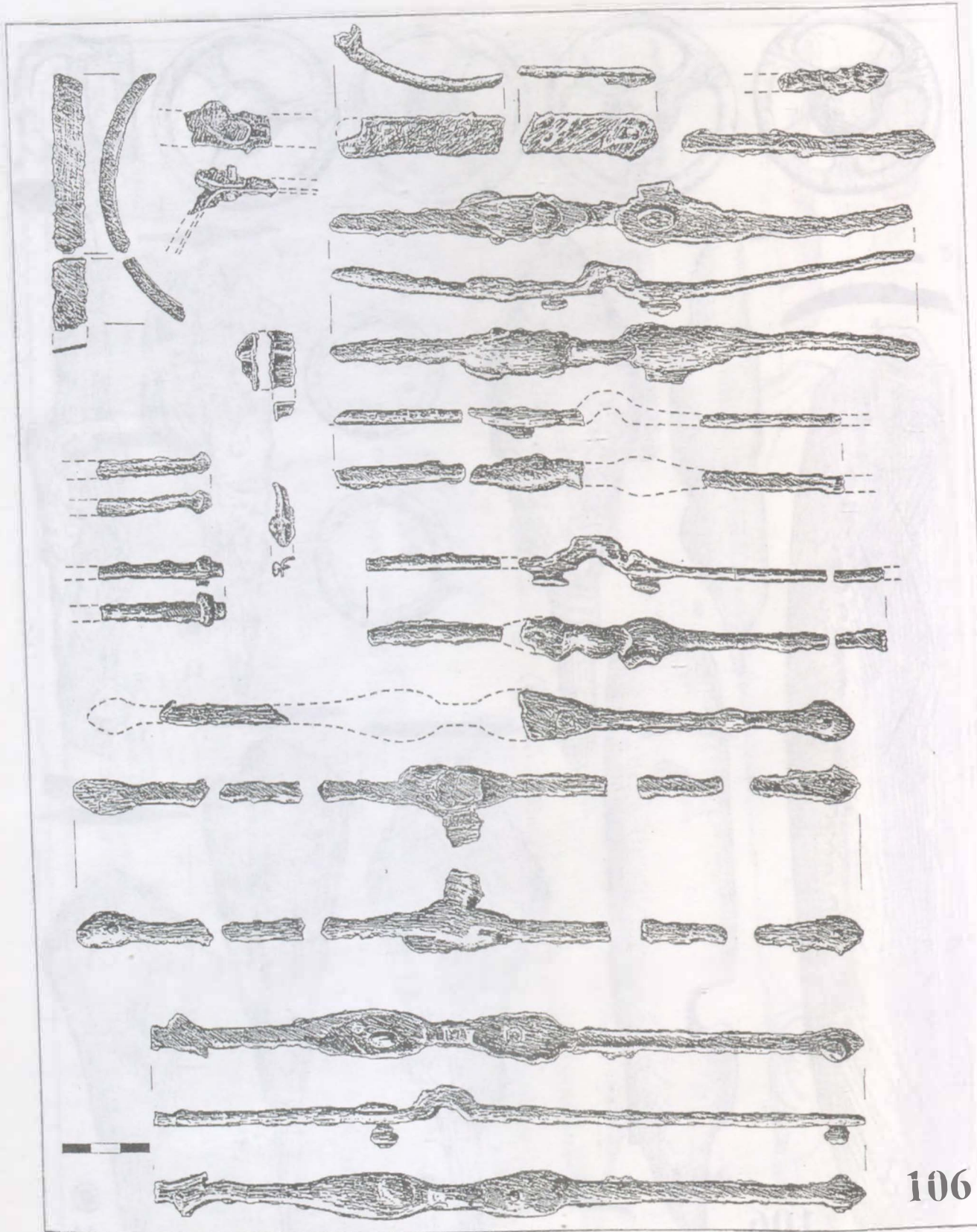

266. tábla: Sárrétudvari-Hízóföld. 106. sír (1:2)

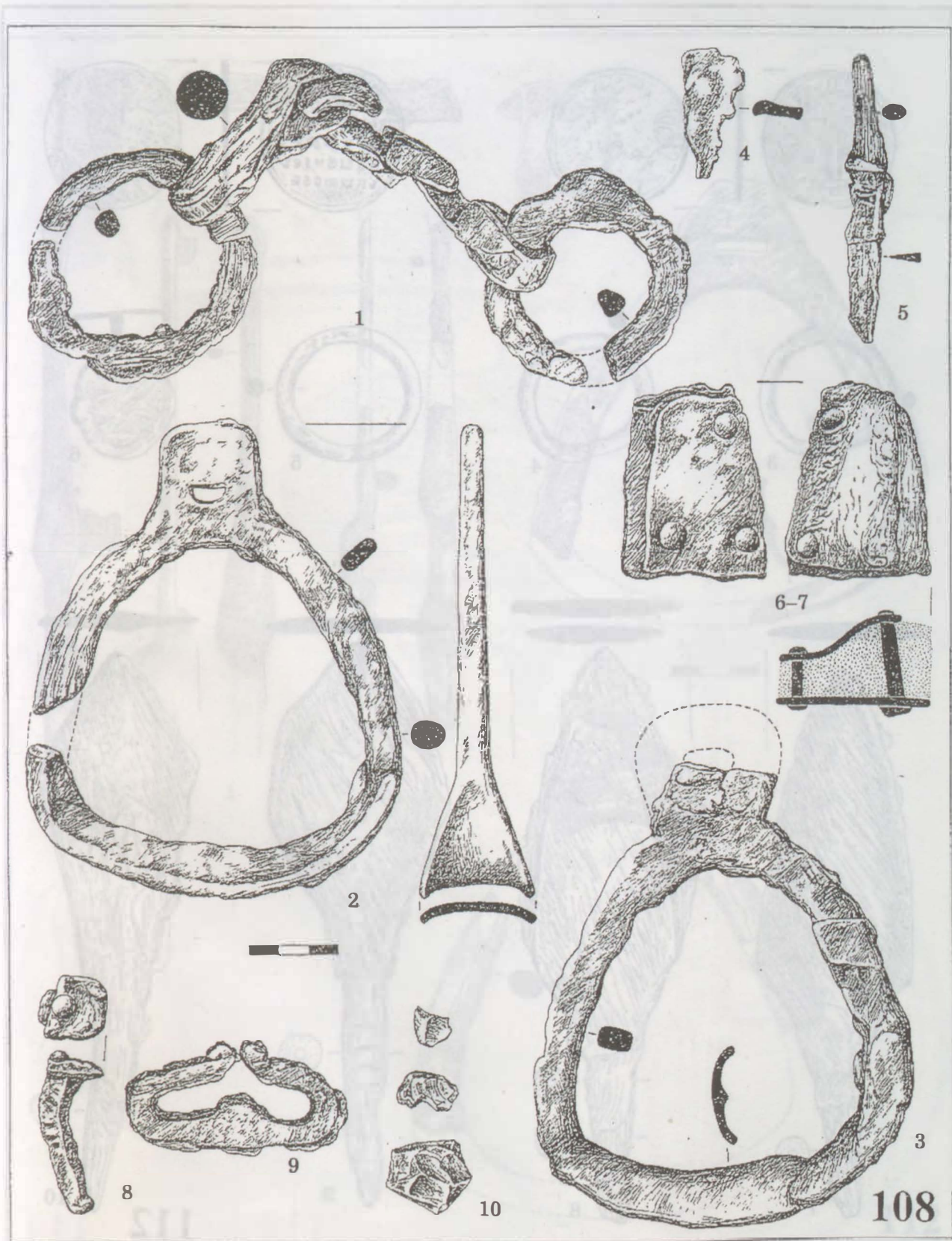

267. tábla: Sárrétudvari-Hízóföld. 108. sír (1:2)

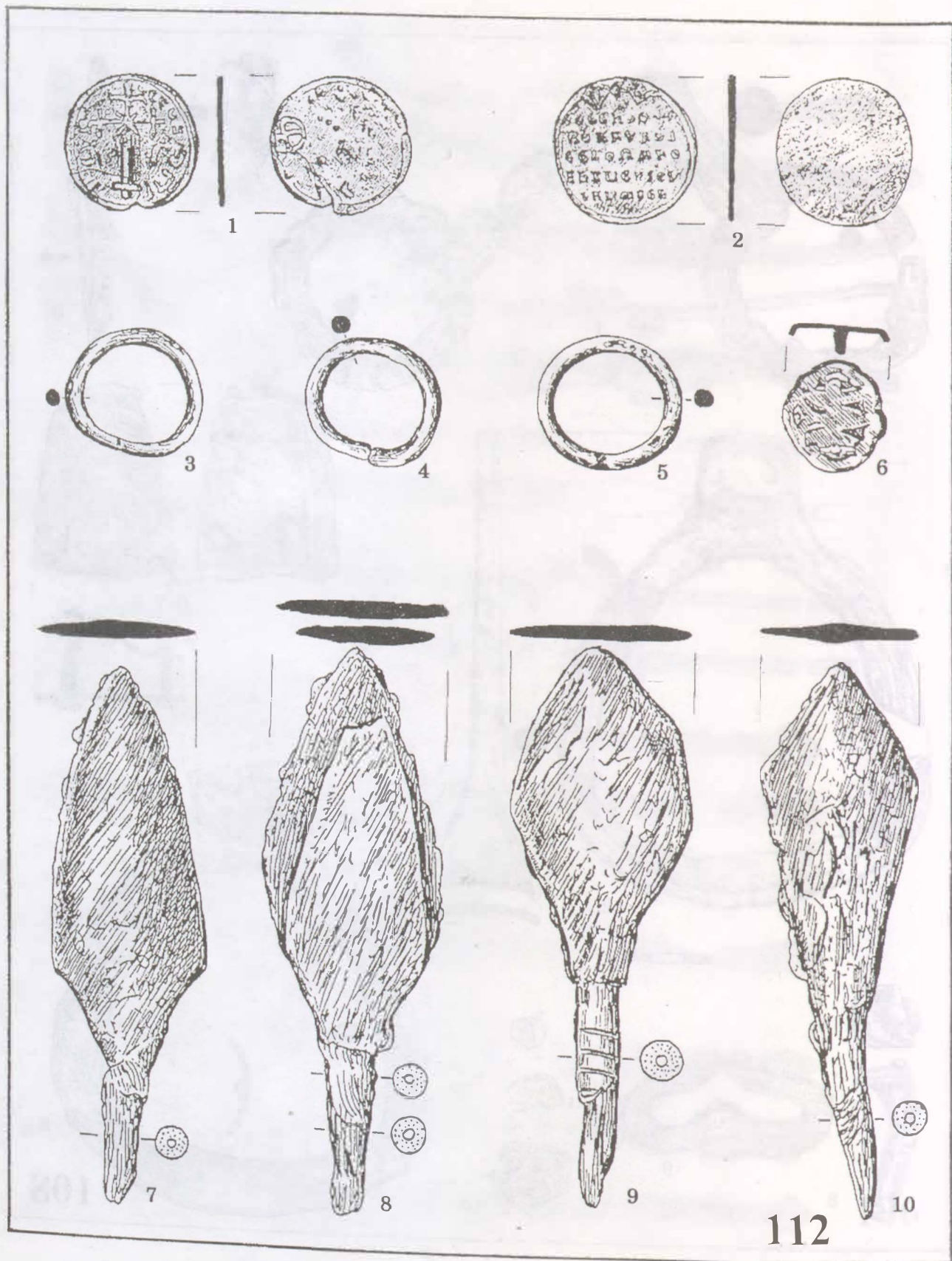

268. tábla: Sárrétudvari-Hízófold. 112. sír (1:1)

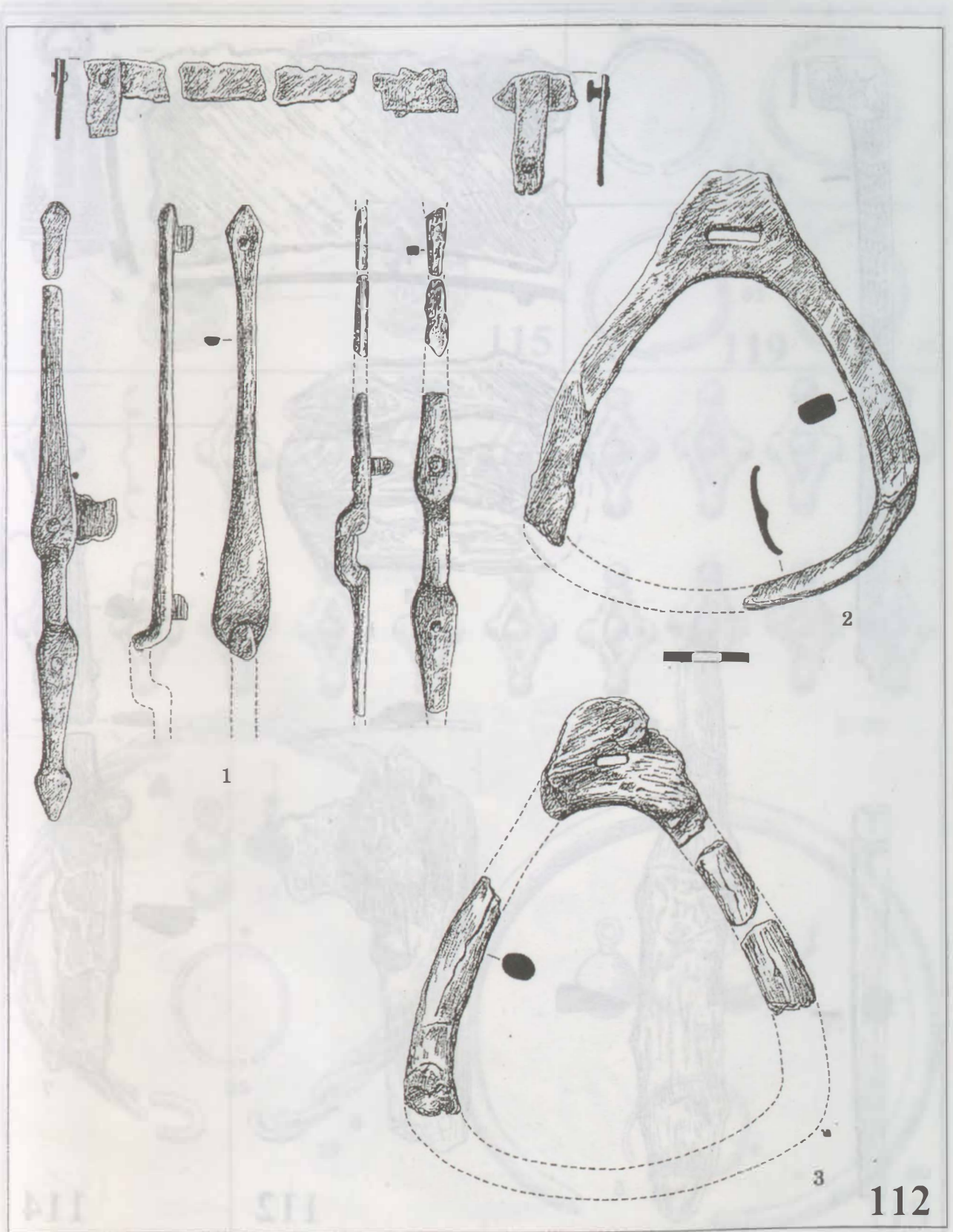

269. tábla: Sárrétudvari-Hízófold. 112. sír (1:2)

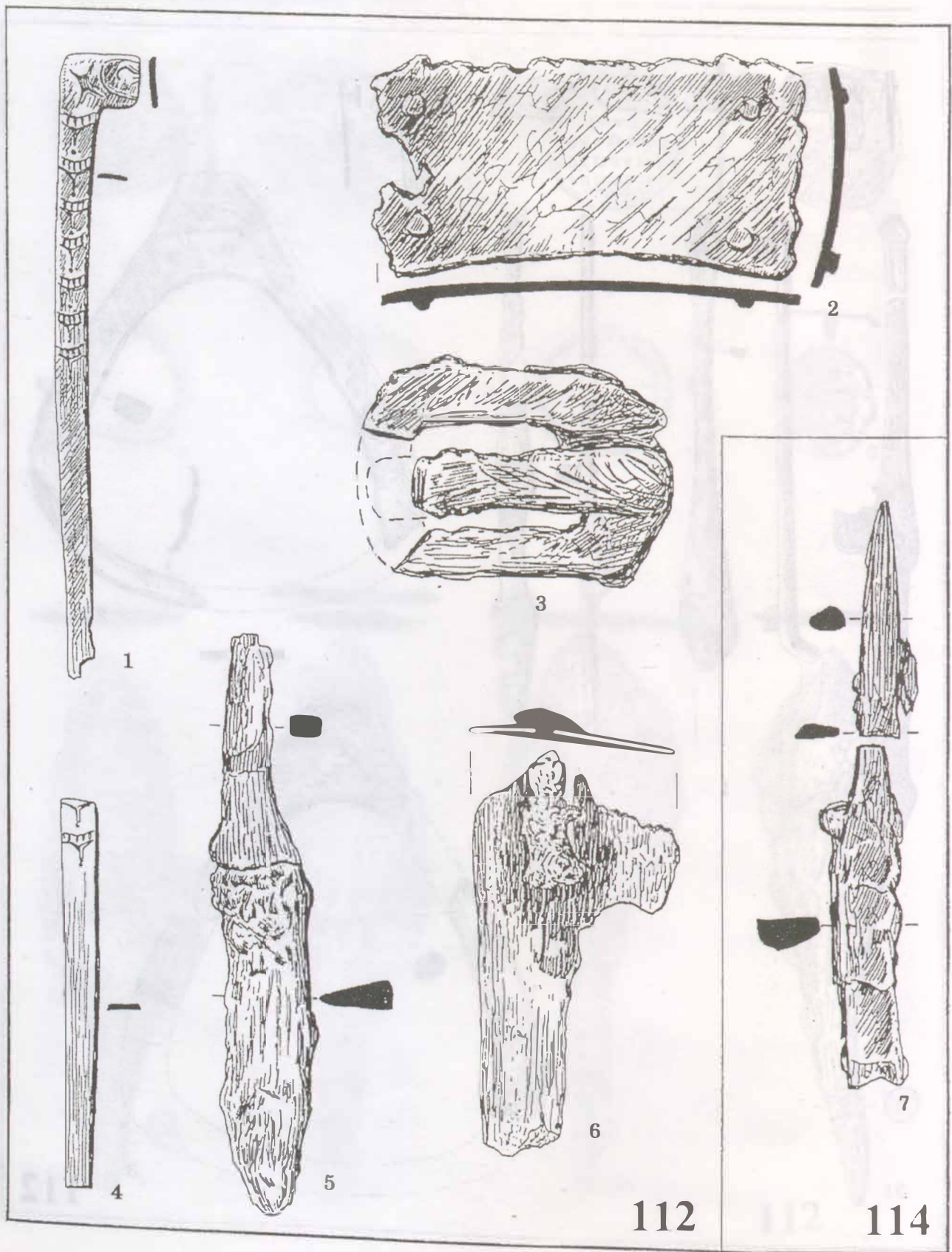

270. tábla: Sárrétudvari-Hízóföld. 112., 114. sír (1:1)

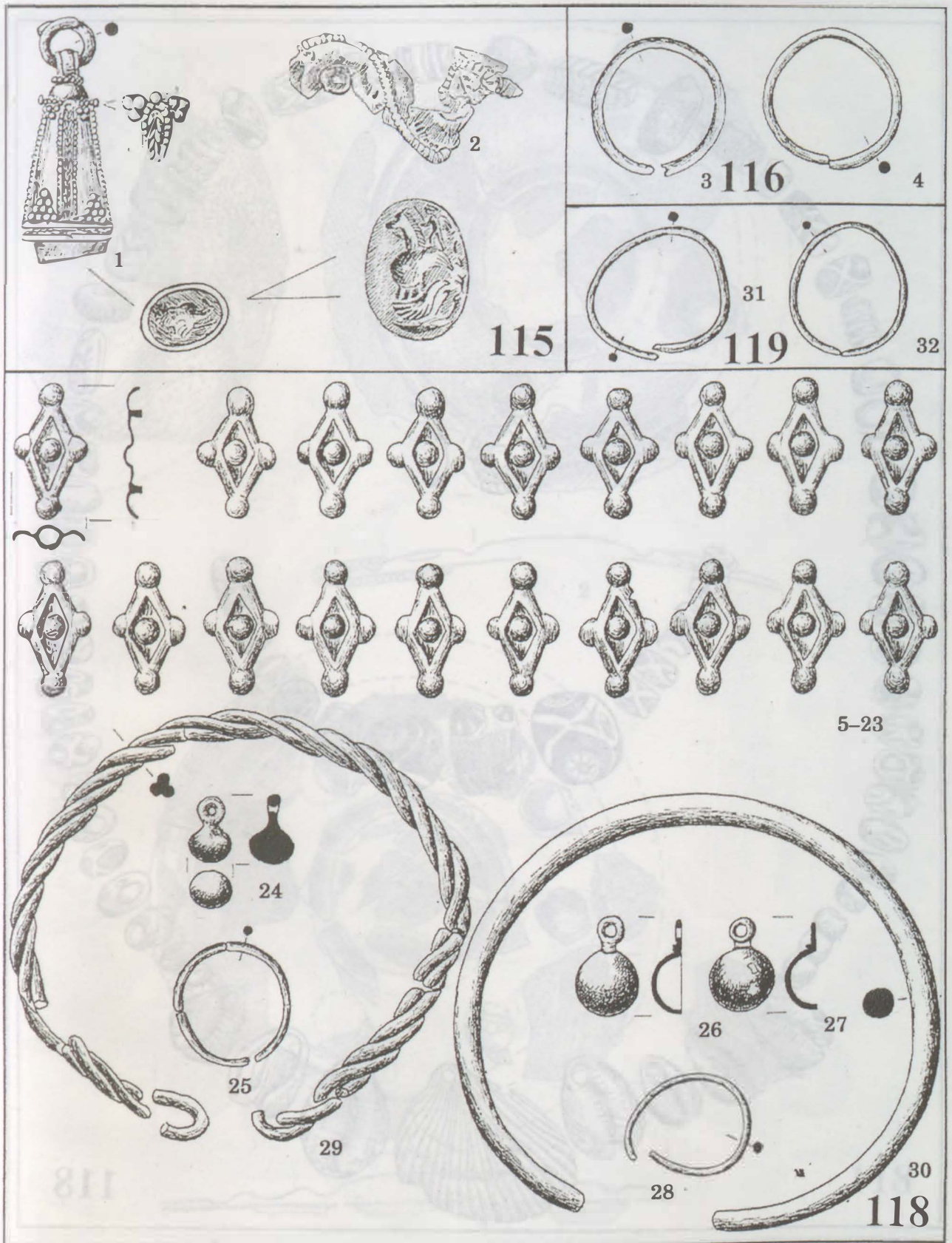

271. tábla: Sárétudvari-Hízföld. 115–116., 118–119. sír (1:1)



272. tábla: Sárretudvari-Hízóföld. 118. sír (1:1)

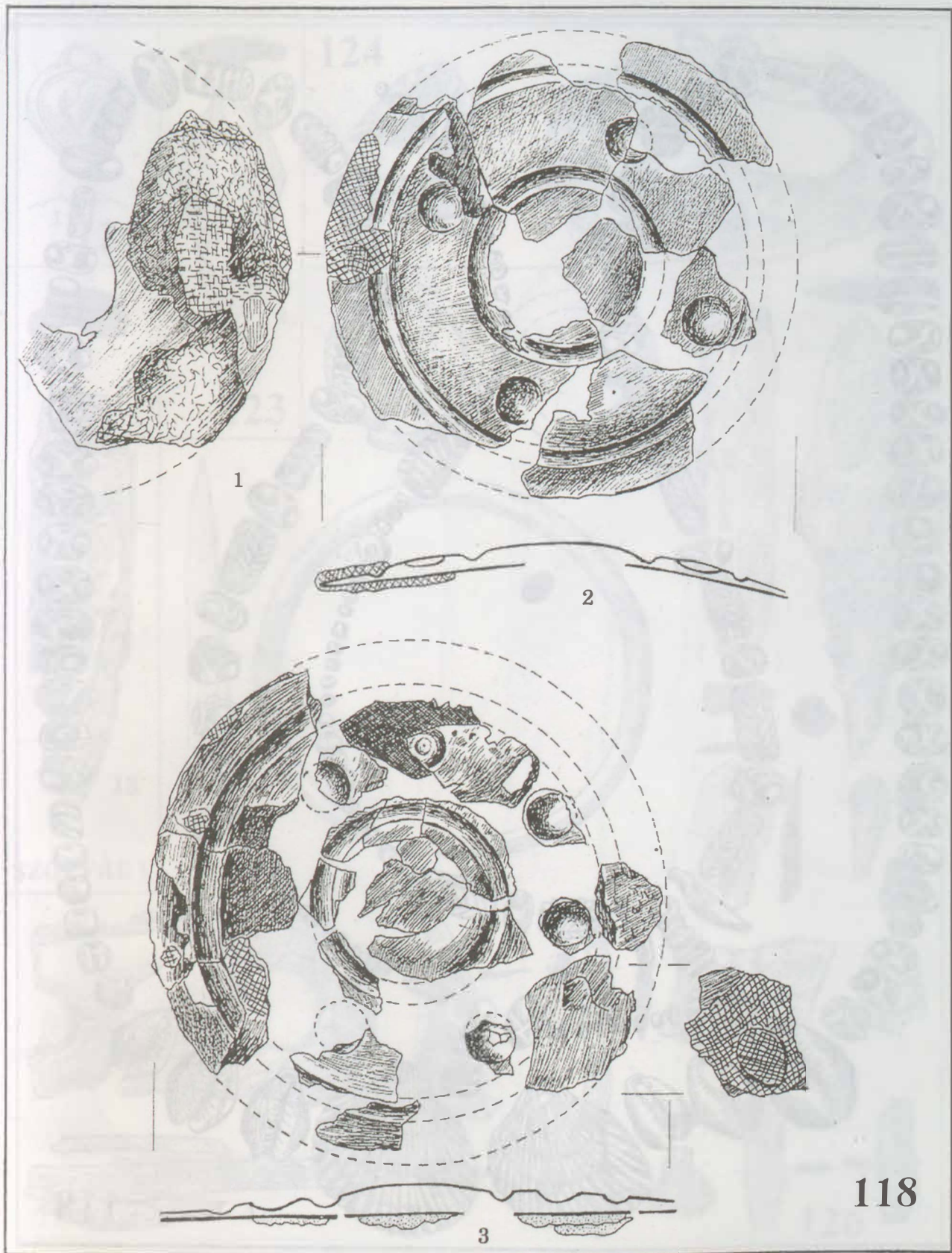

273. tábla: Sárrétudvari-Hízóföld. 118. sír (1:1)

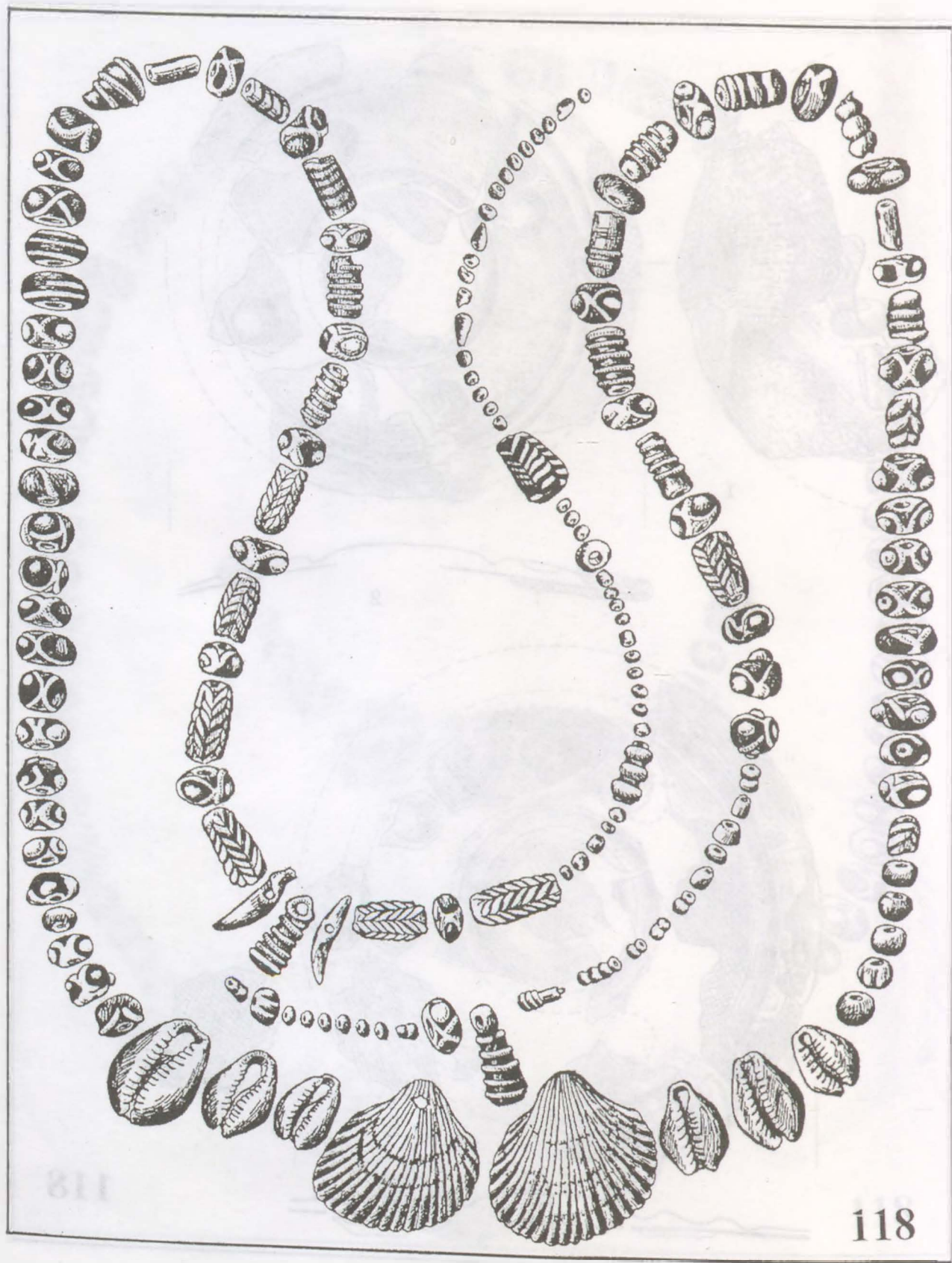

274. tábla: Sárretudvari-Hízóföld. 118. sír (1:1)

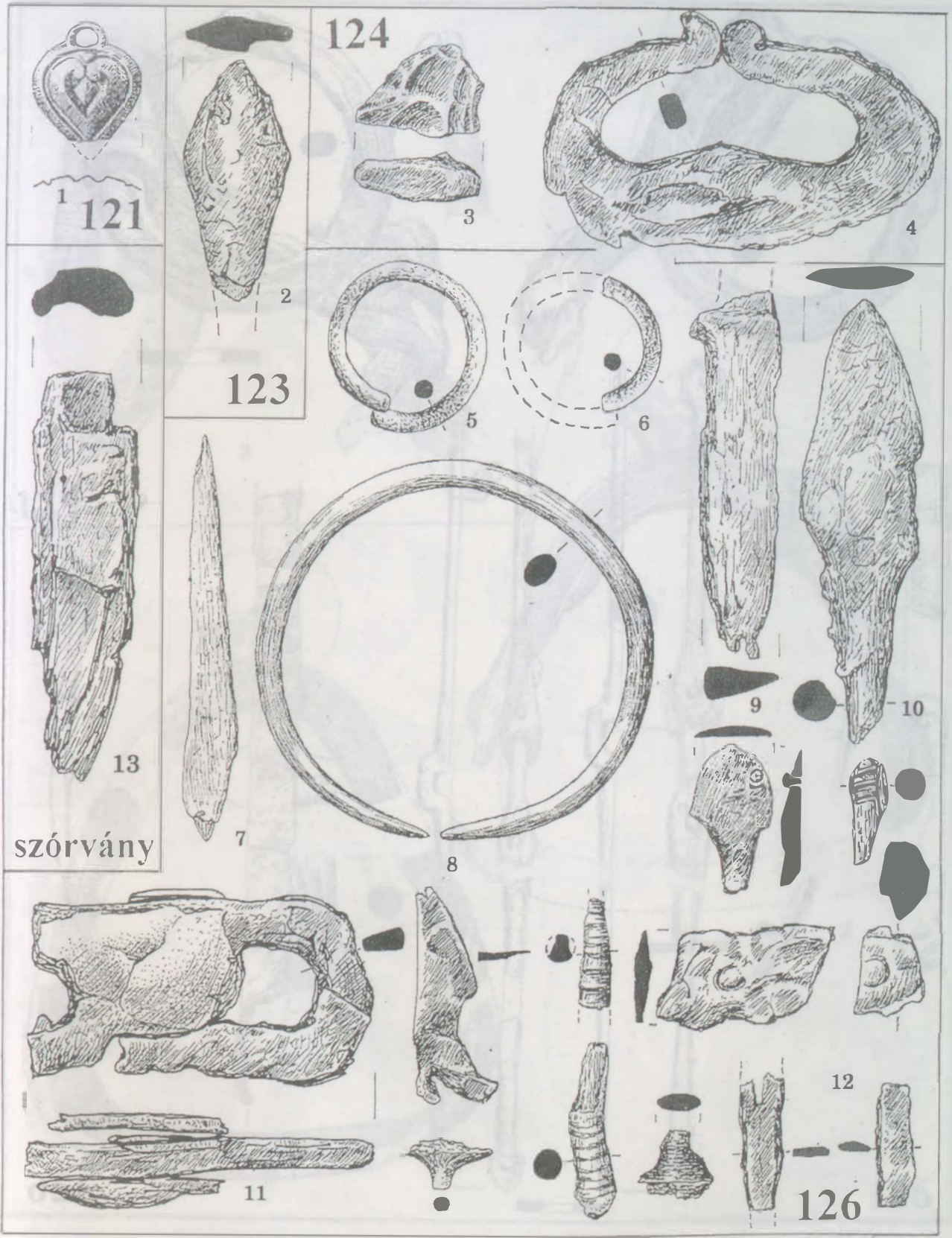

275. tábla: Sárrétudvari-Hízóföld. 121., 123-124., 126. sír és szórvány (1:1)

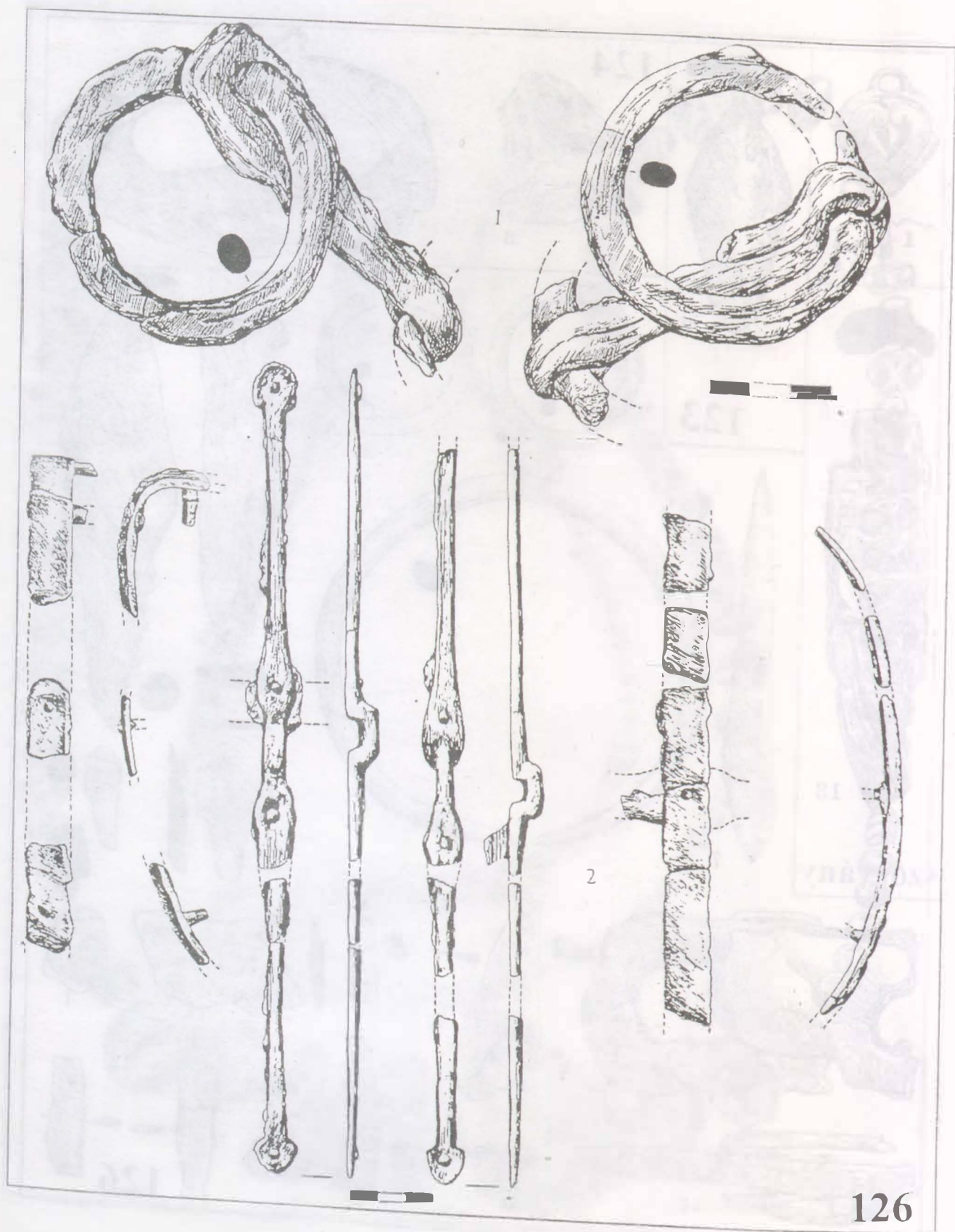

126

276. tábla: Sárrétudvari-Hízófold. 126. sír (1. 75%; 2. 1:2)

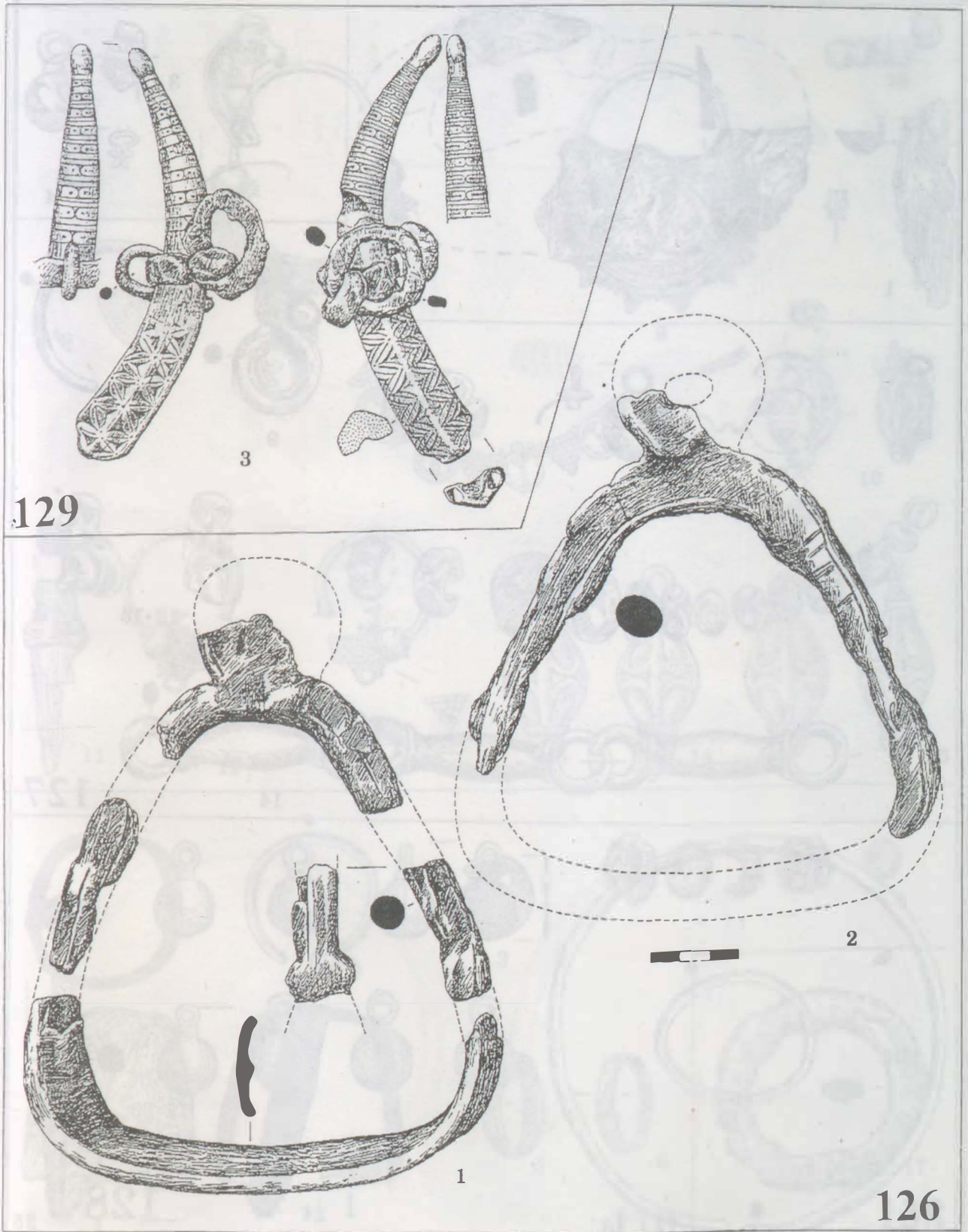

277. tábla: Sárrétudvari-Hízóföld. 126., 129. sír (1:2)

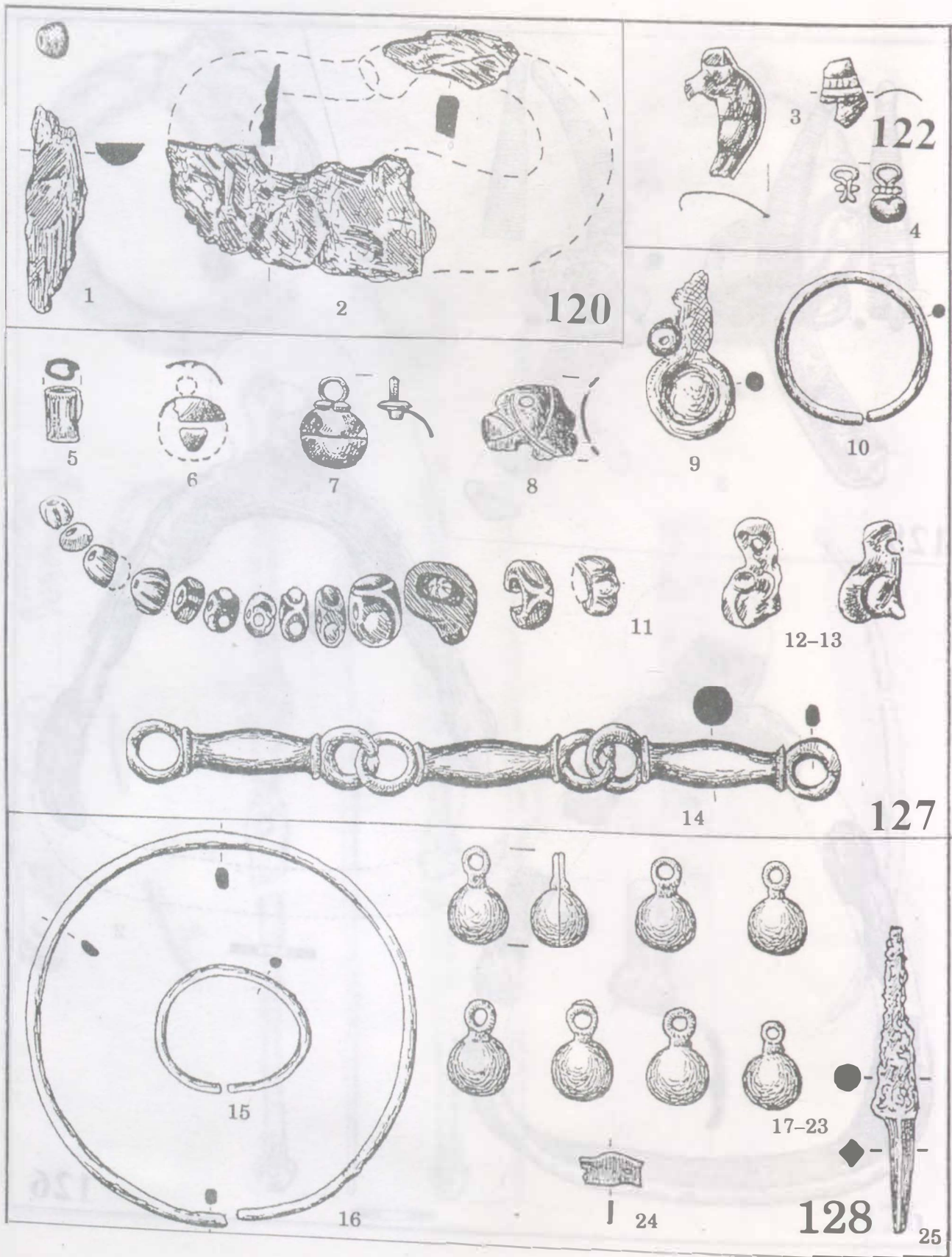

278. tábla: Sárrétudvari-Hízófold. 120., 122., 127-128. sír (1:1)

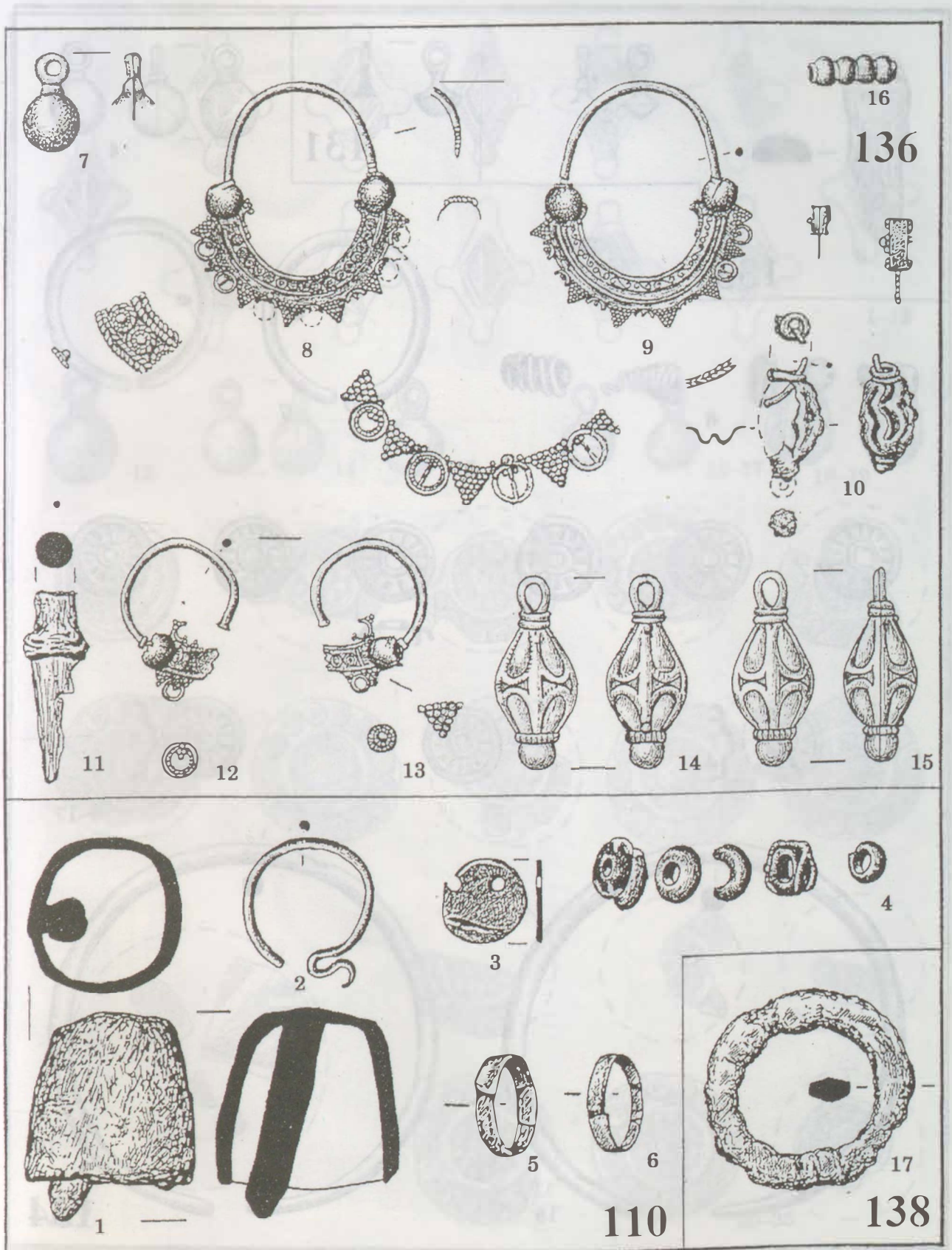

279. tábla: Sárretudvari-Hízófold. 110., 136., 138. sír (1:1)

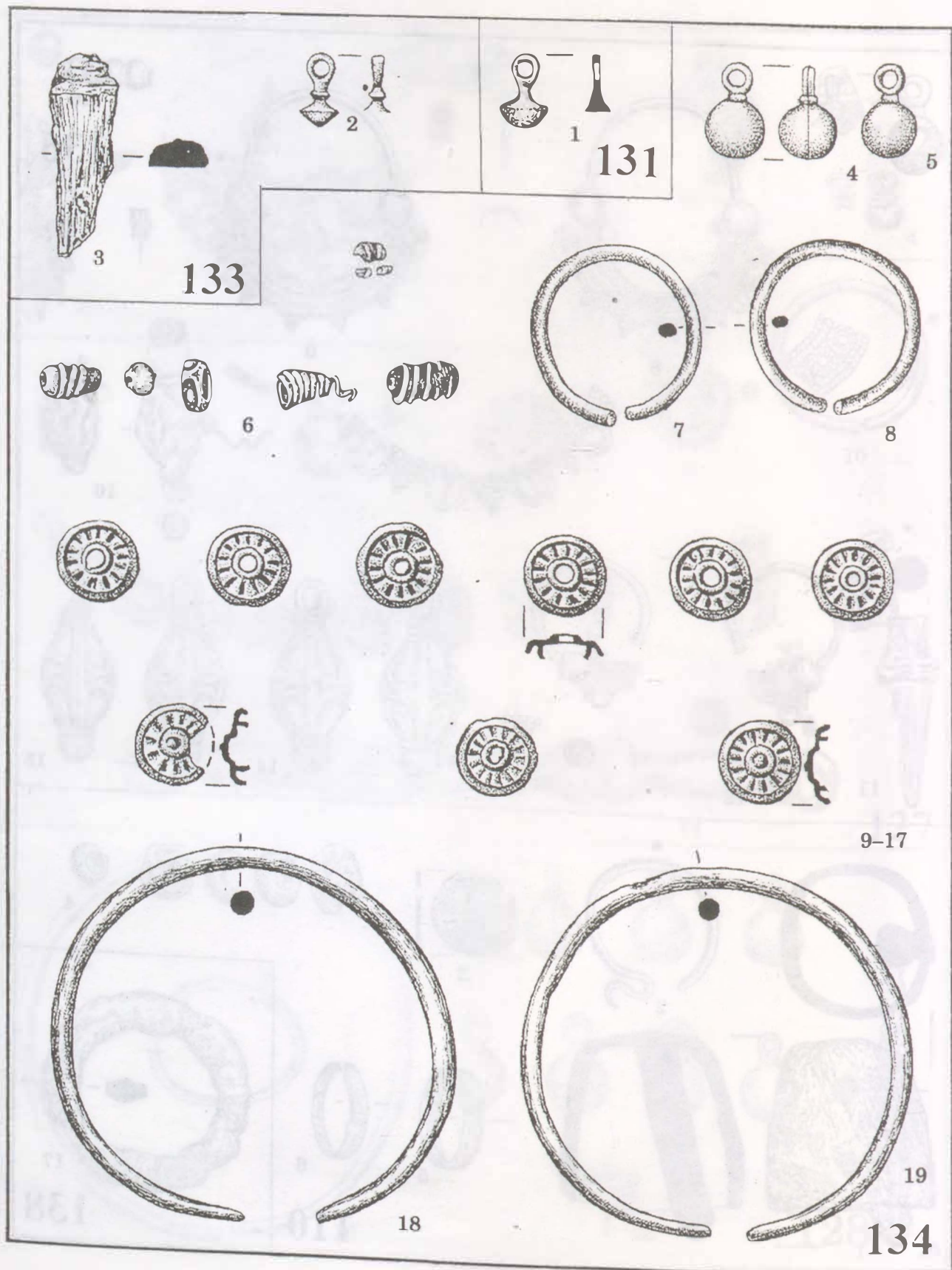

280. tábla: Sárrétudvari-Hízóföld. 131., 131-134. sír (1:1)

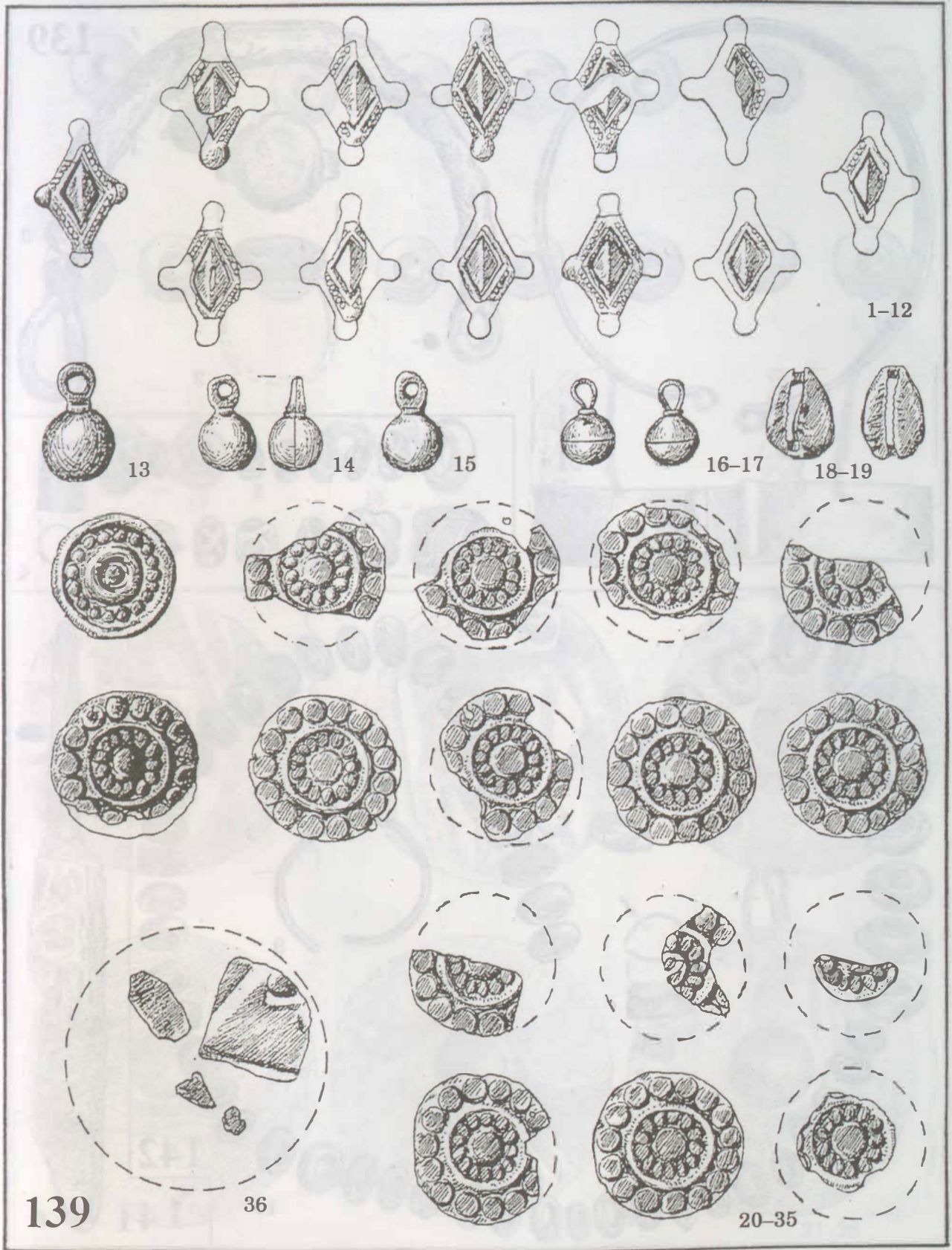

281. tábla: Sárretudvari-Hízóföld. 139. sír (I:1)

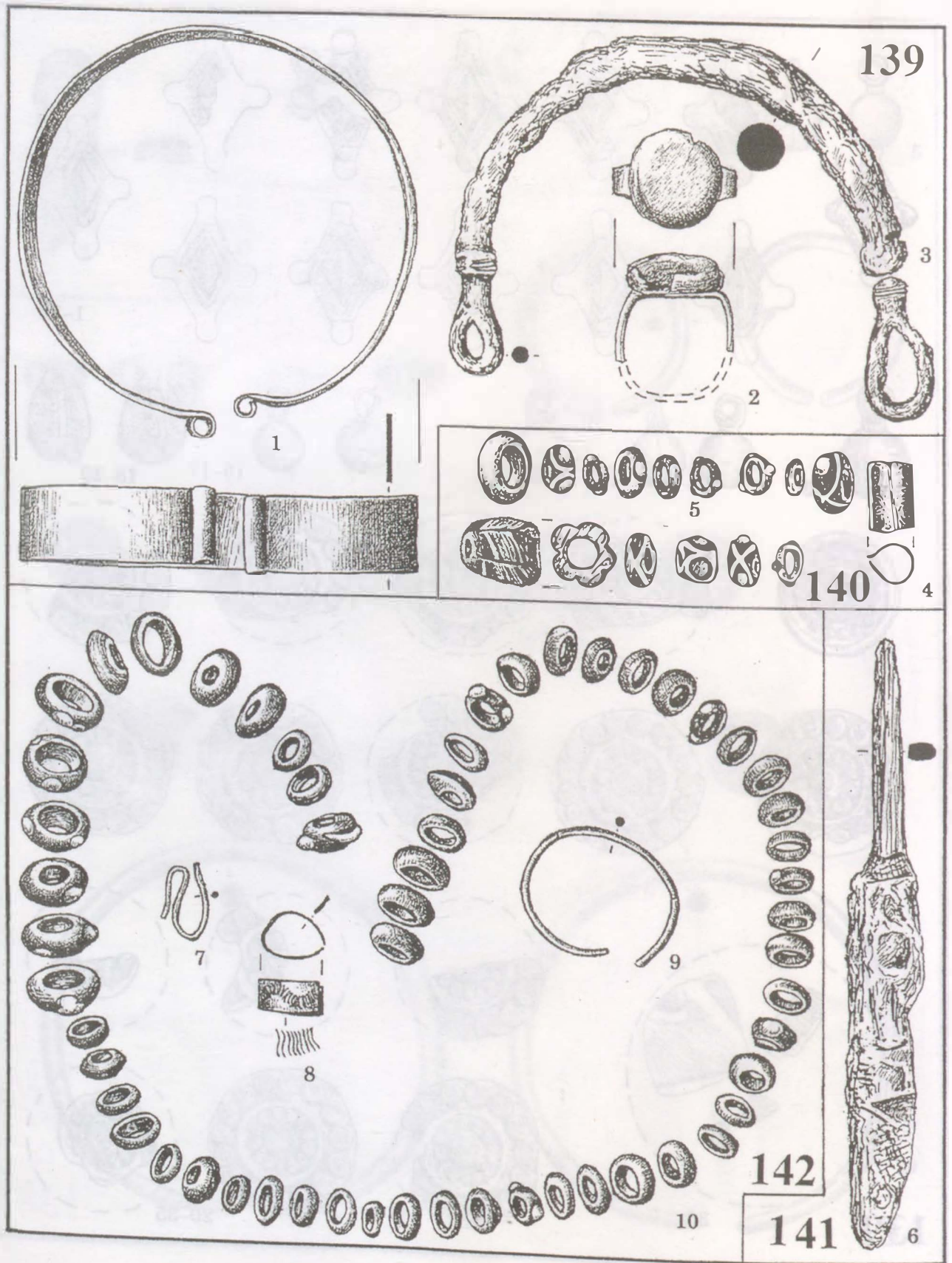

282. tábla: Sárrétudvari-Hízófold. 139-142. sír (1:1)

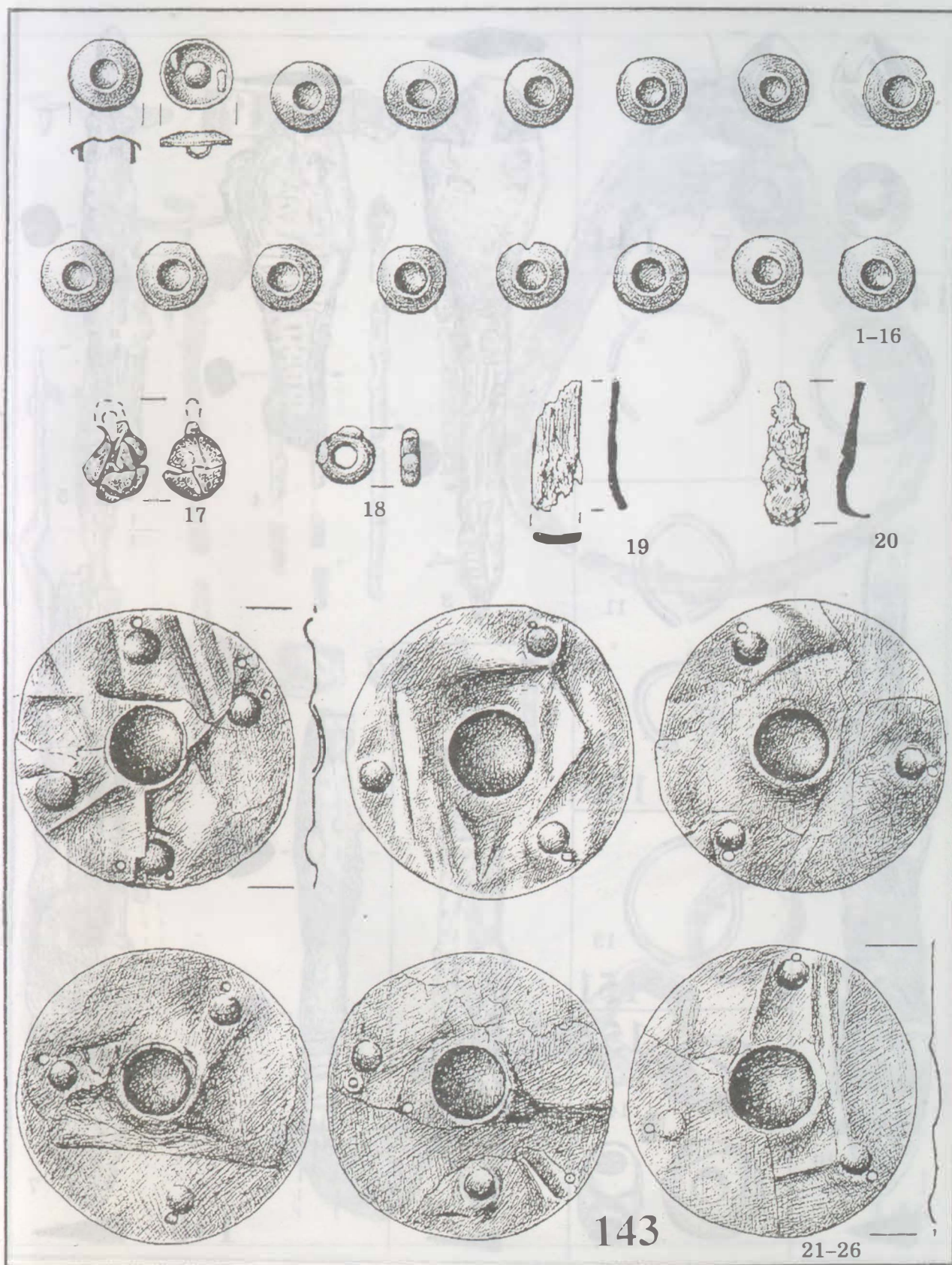

283. tábla: Sárrétudvari-Hízóöld. 143. sír (1:1)

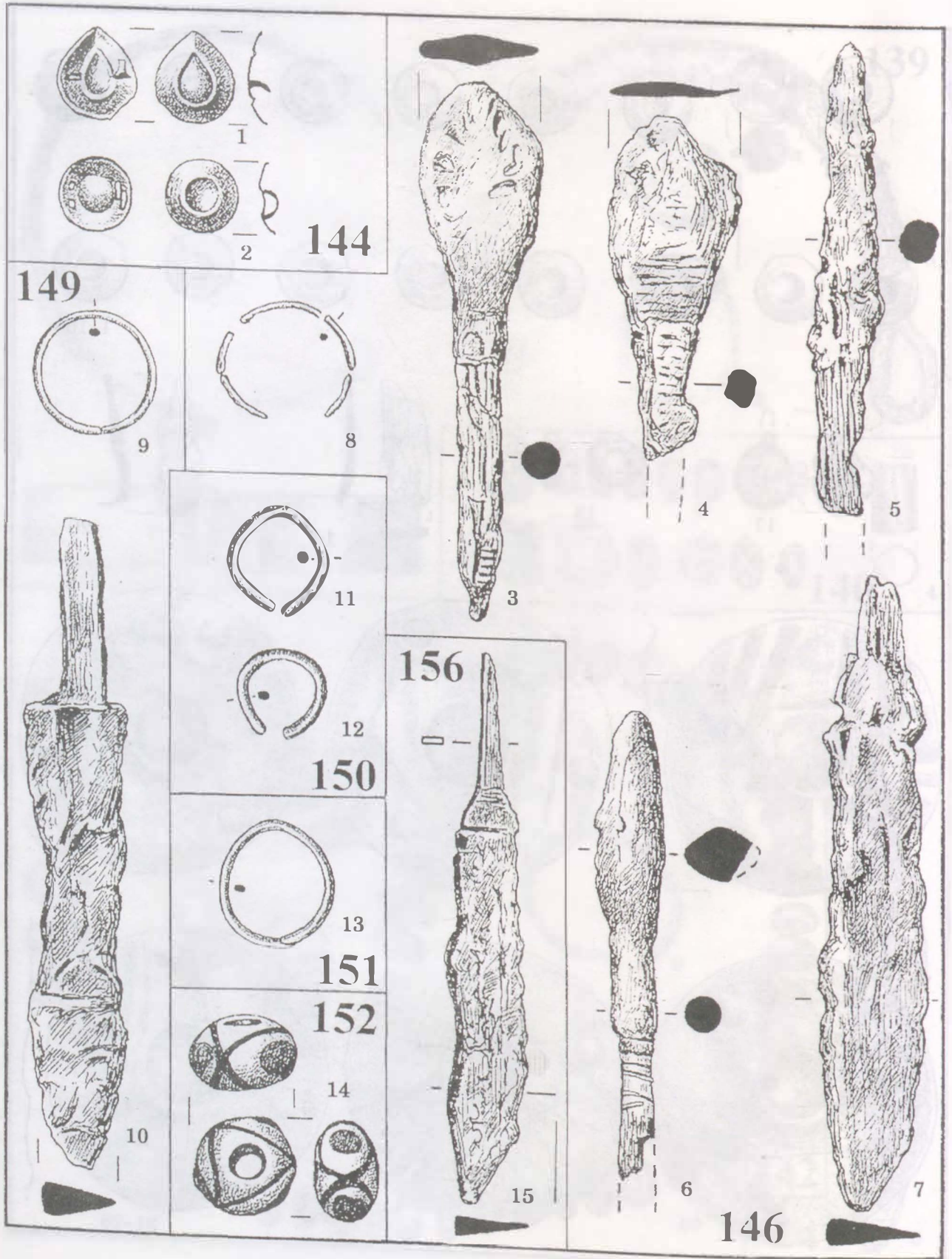

284. tábla: Sárrétudvari-Hízófold. 144., 146., 149-152., 156. sír (1:1)



285. tábla: Sárrétudvari-Hízóföld. 146. sír (1:2)

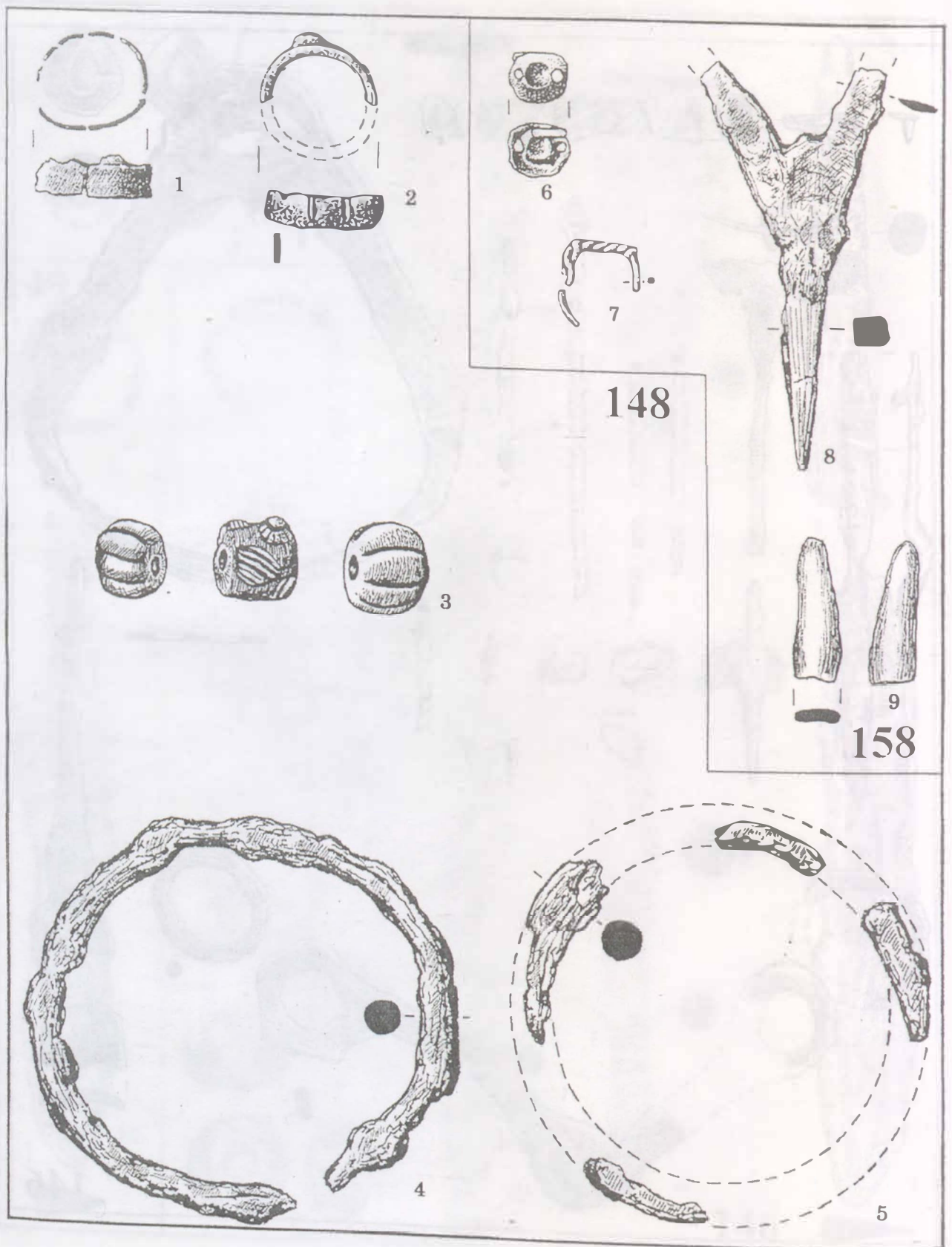

286. tábla: Sárrétudvari-Hízófold. 148., 158. sír (1:1)

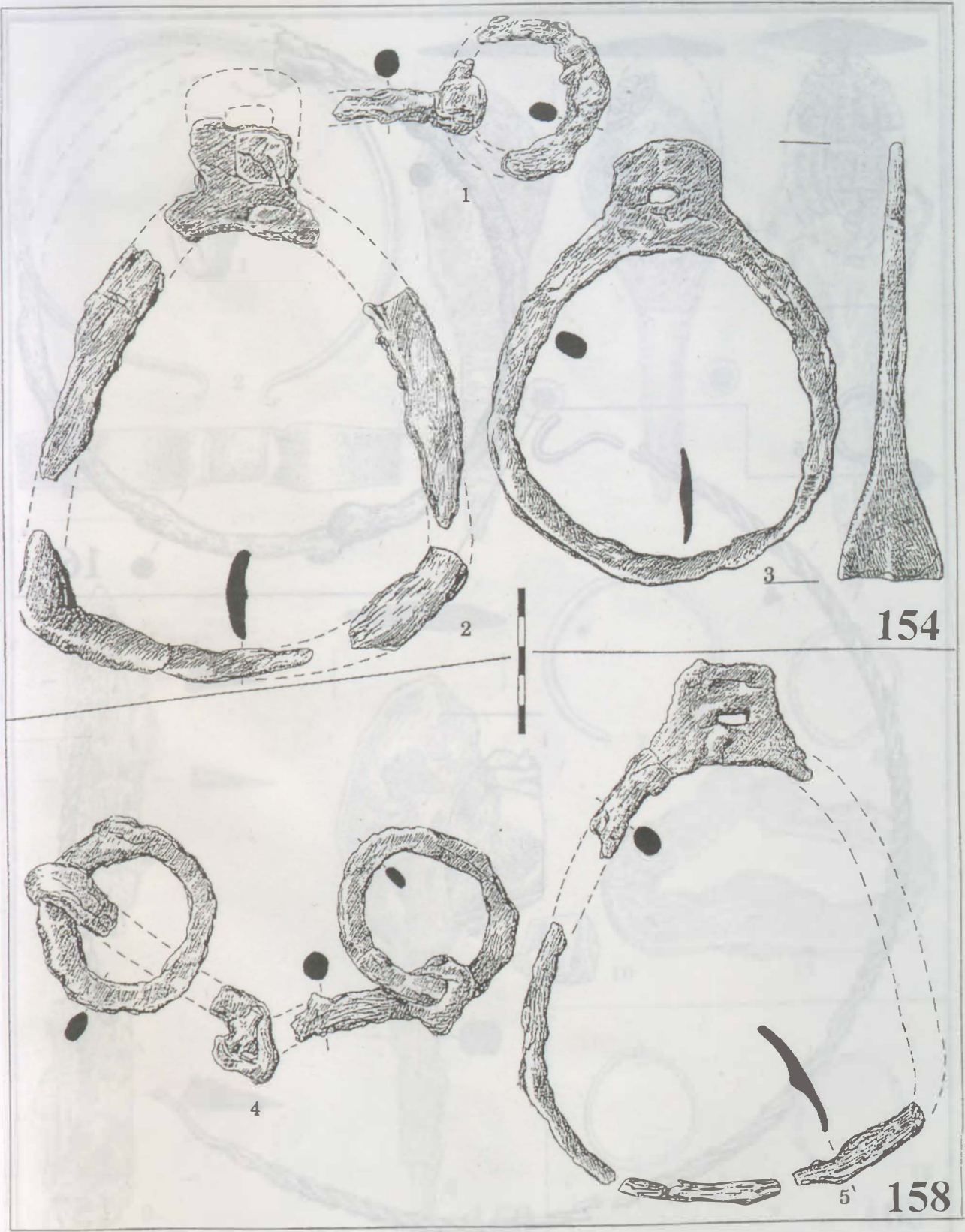

287. tábla: Sárrétudvari-Hízóöld. 154., 158. sír (1:2)

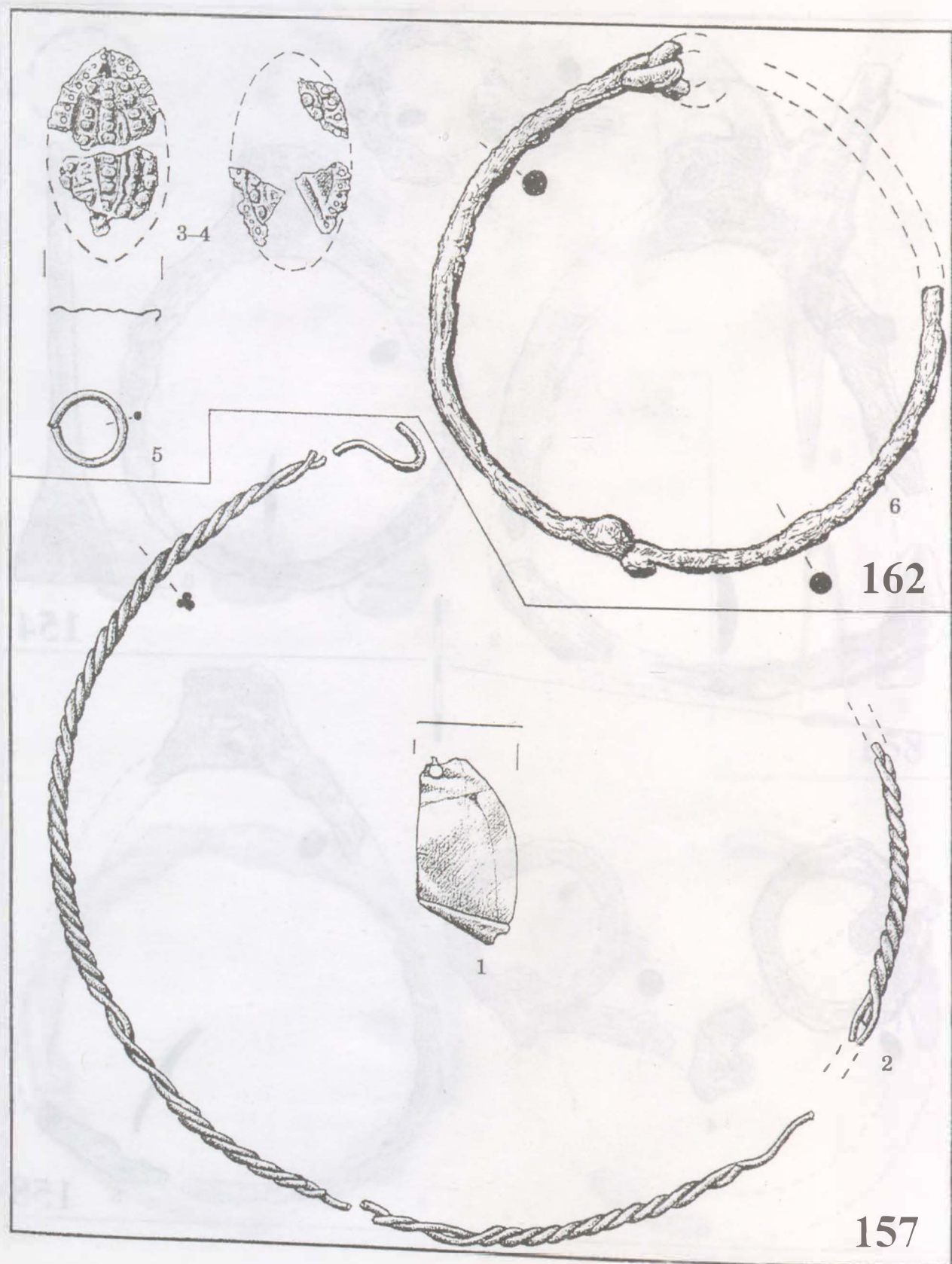

288. tábla: Sárrétudvari-Hízófold. 157., 162. sír (1:1)

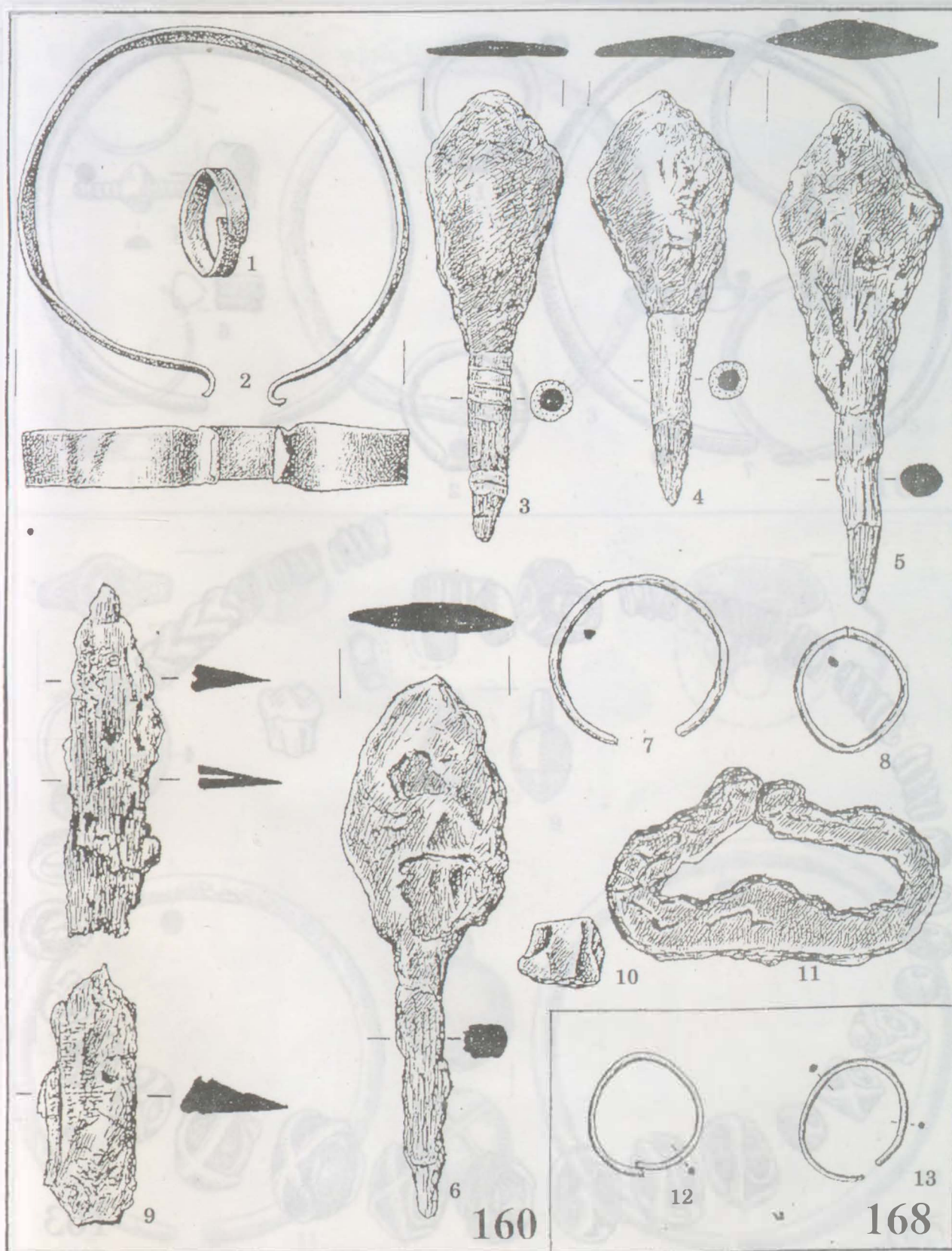

289. tábla: Sárrétudvari-Hízófold. 160., 168. sír (1:1)

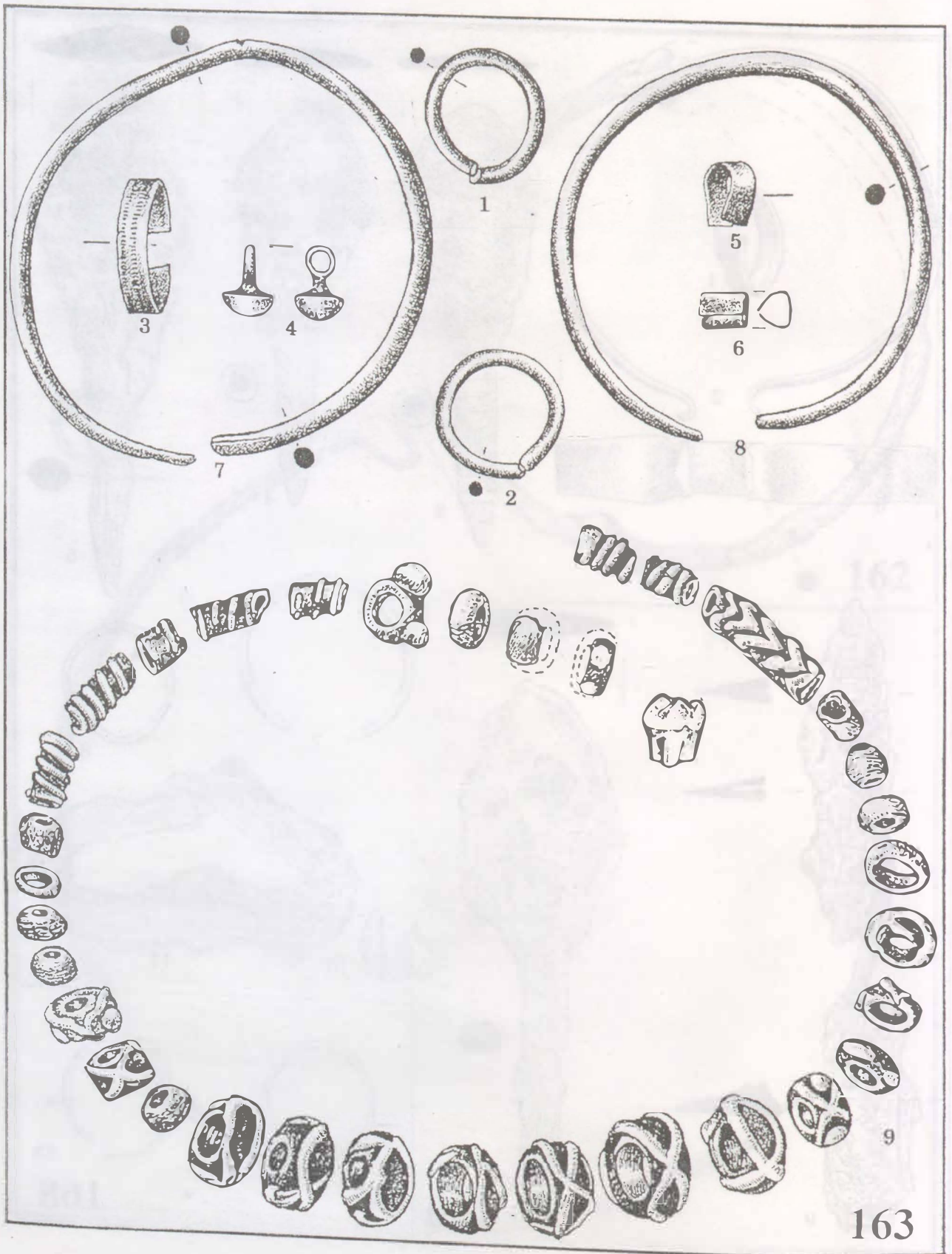

163

290. tábla: Sárrétudvari-Hízóföld. 163. sír (1:1)

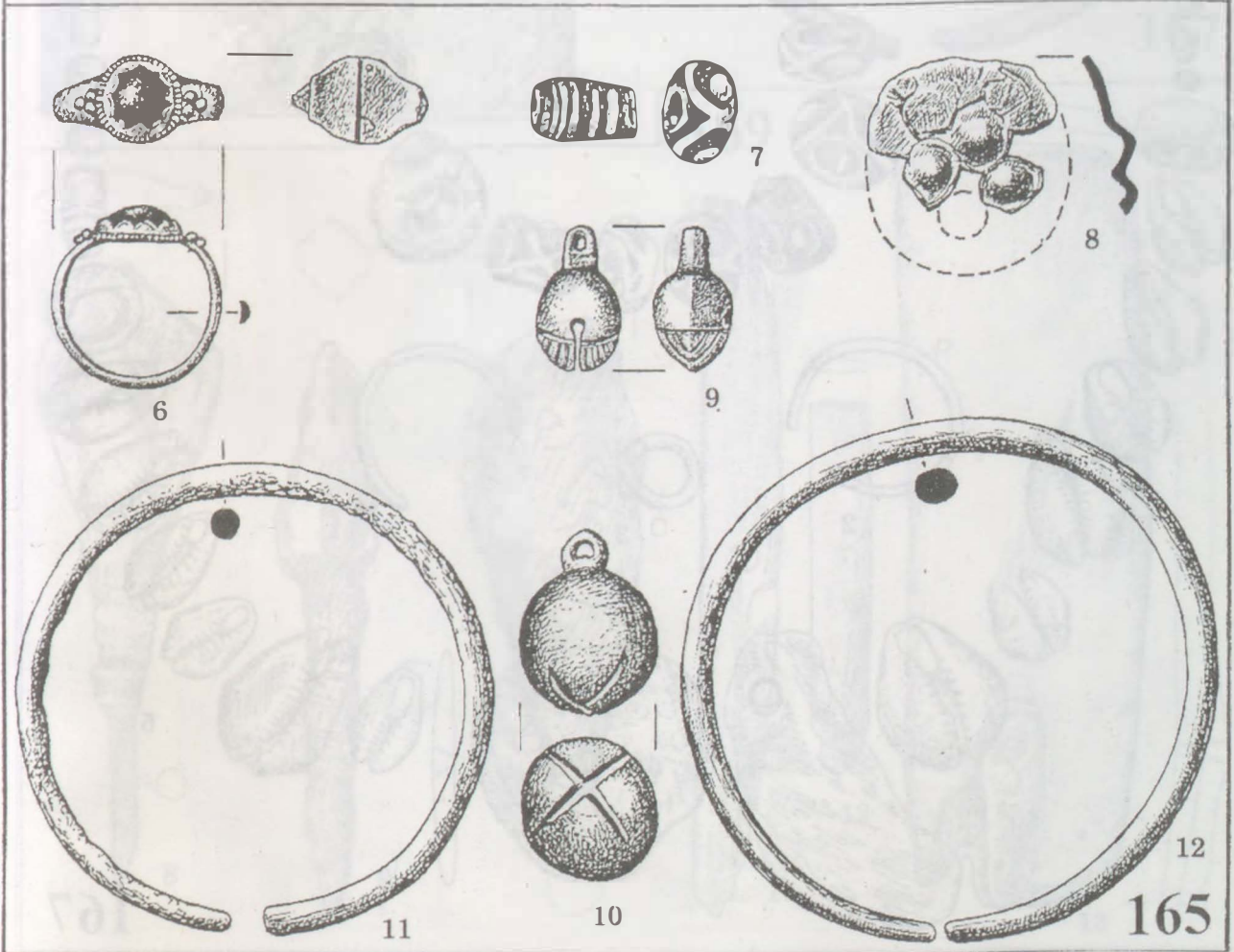
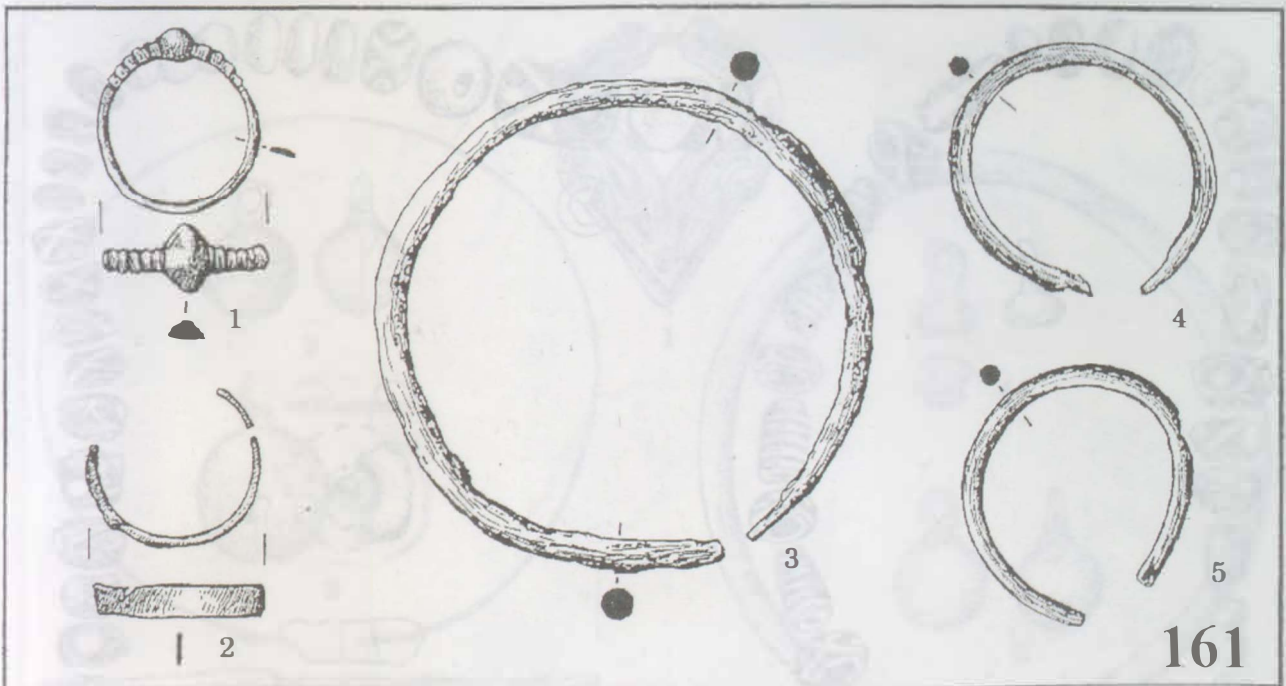

291. tábla: Sárrétudvari-Hízófold. 161., 165. sír (1:1)

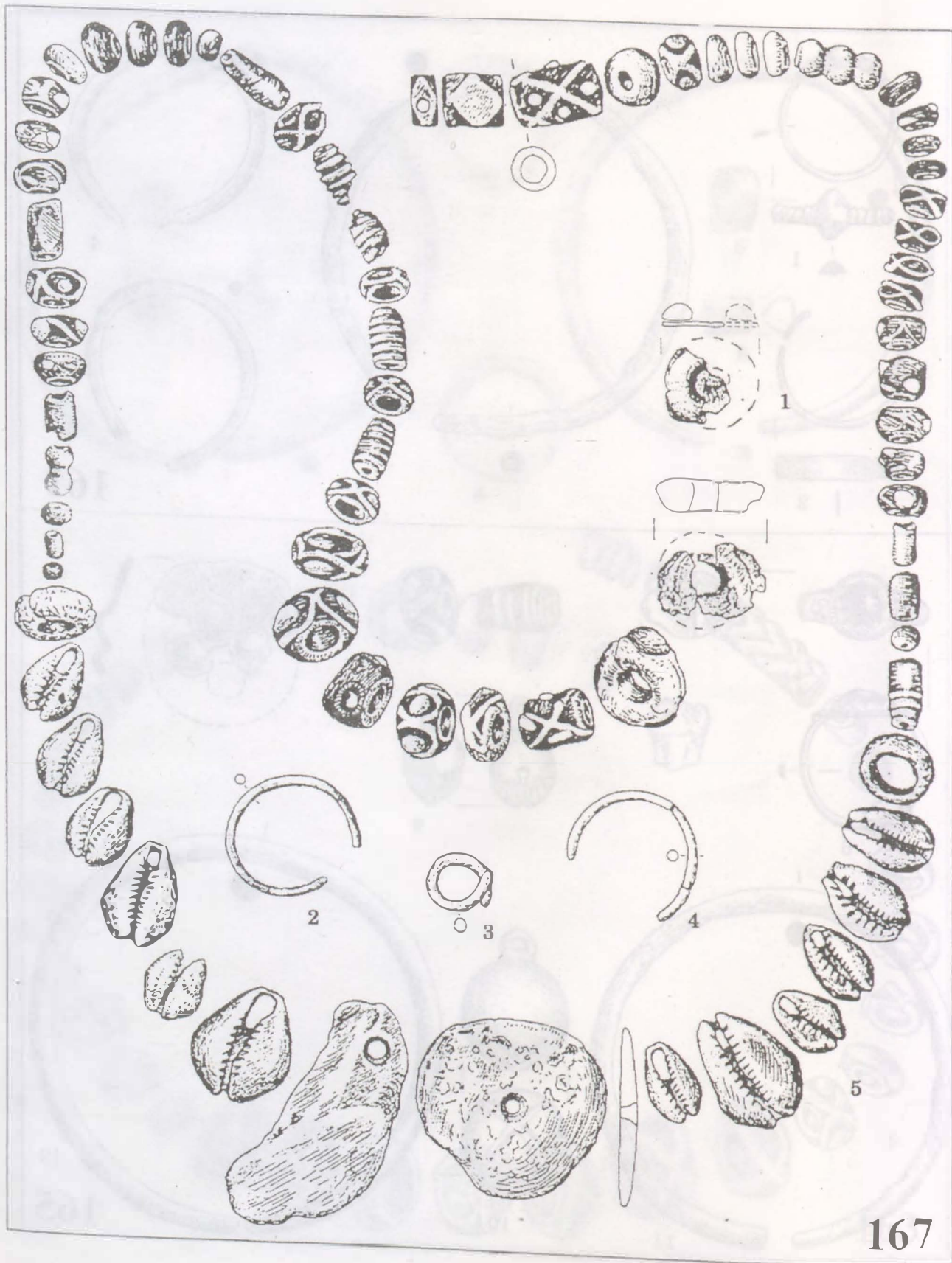

292. tábla: Sárrétudvari-Hízófold. 167. sír (1:1)

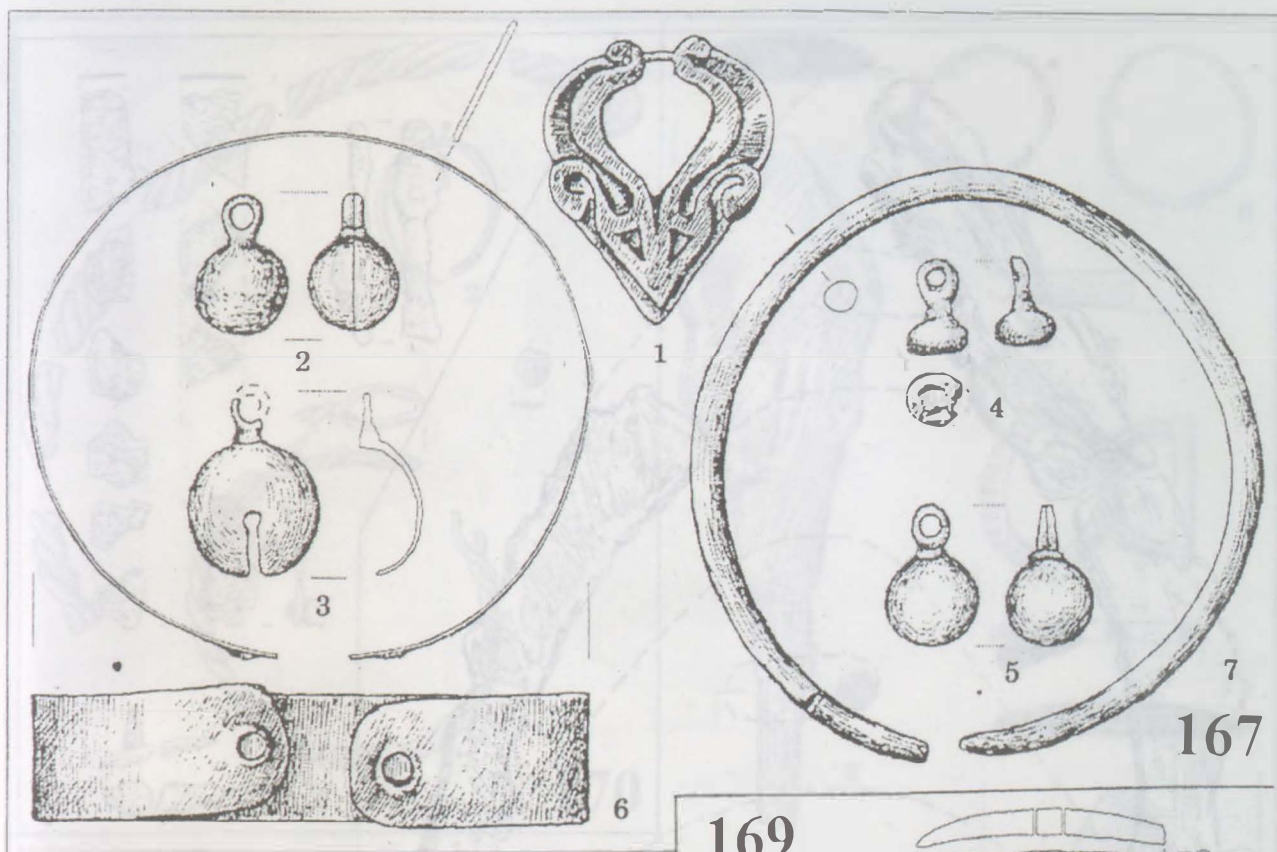

293. tábla: Sárrétudvari-Hízóföld. 167., 169. sír (1:1)

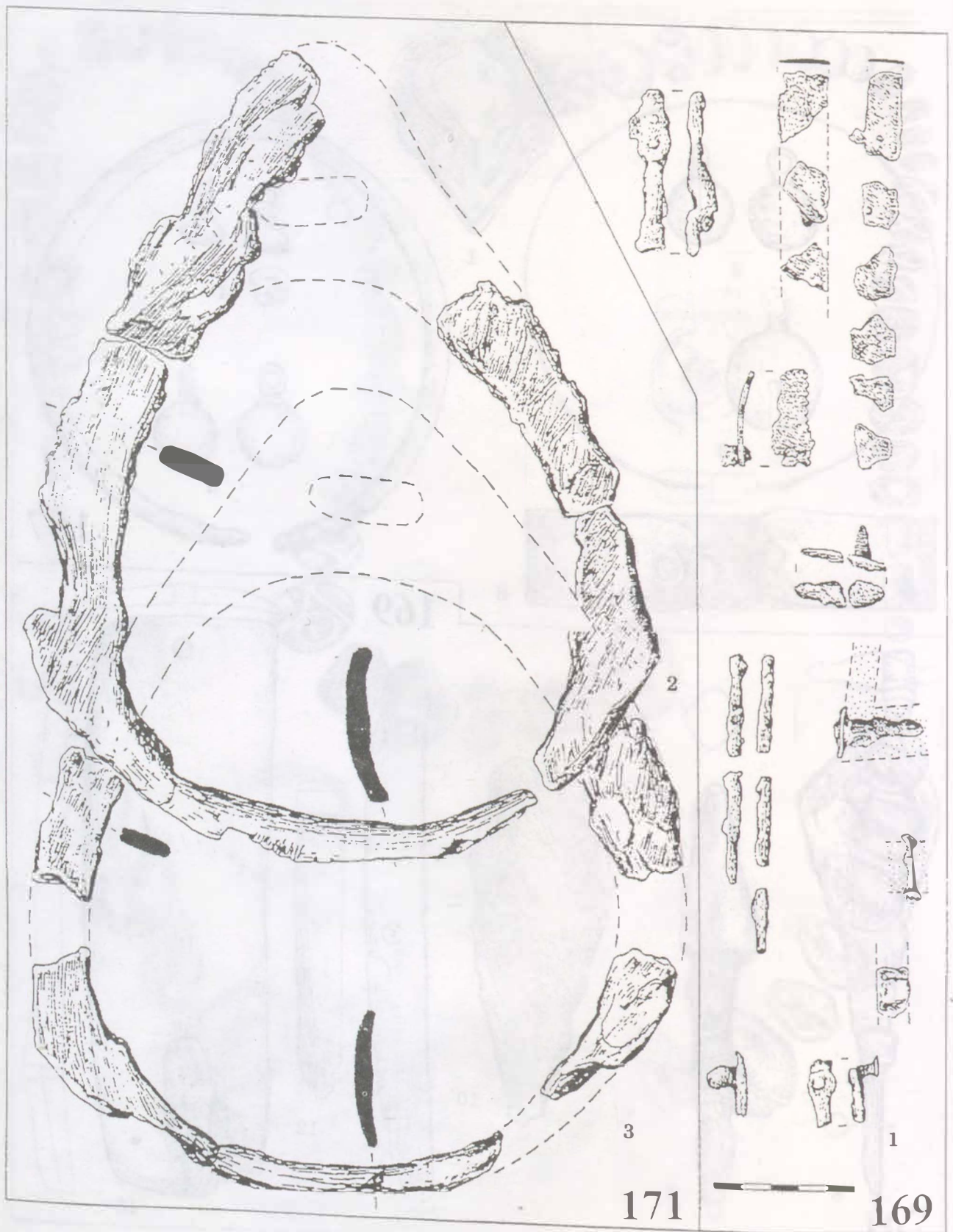

294. tábla: Sárrétudvari-Hízóföld. 169. (1:2), 171. sír (1:1)

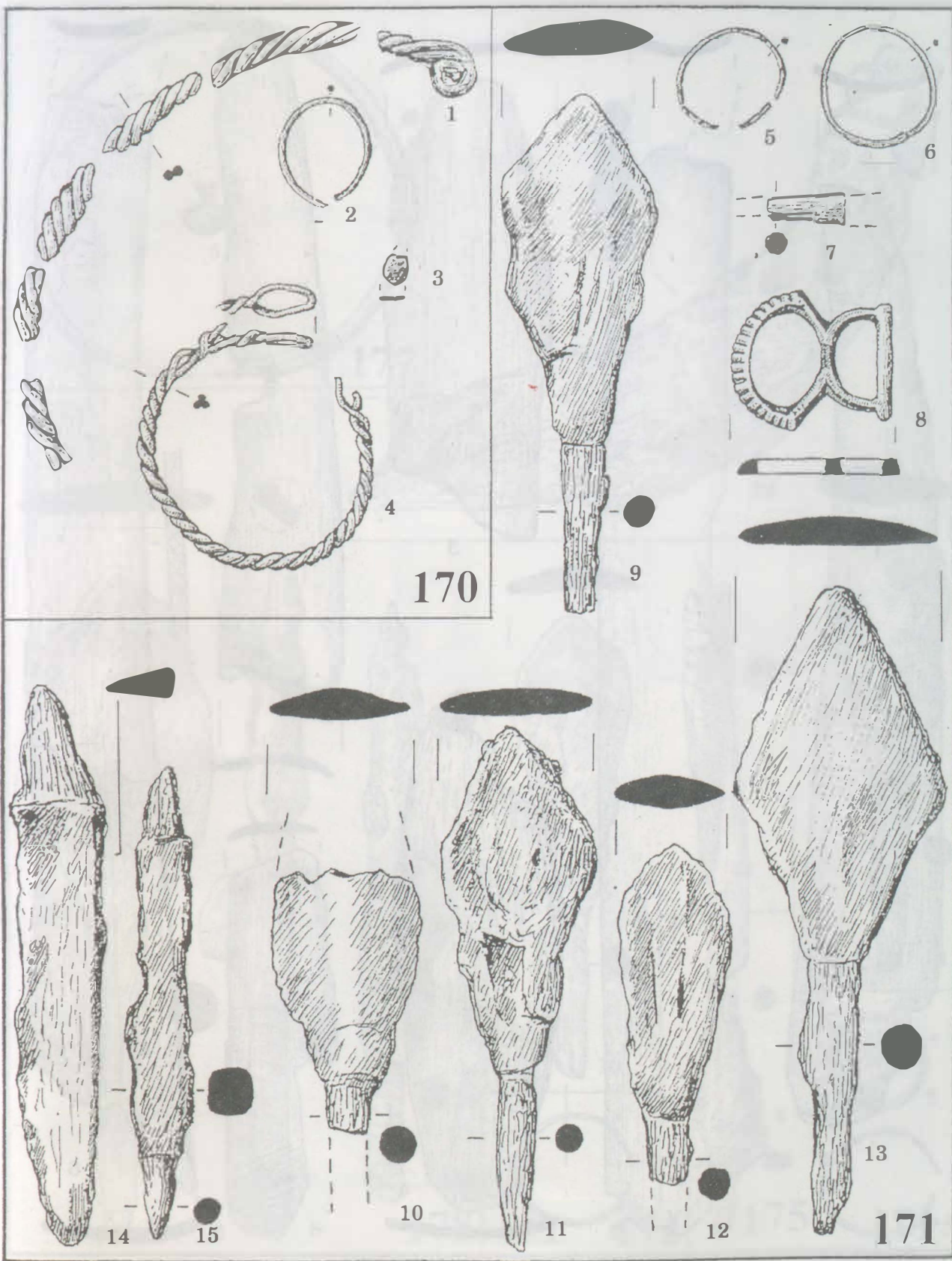

295. tábla: Sárretudvari-Hizóföld. 170-171. sír (1:1)

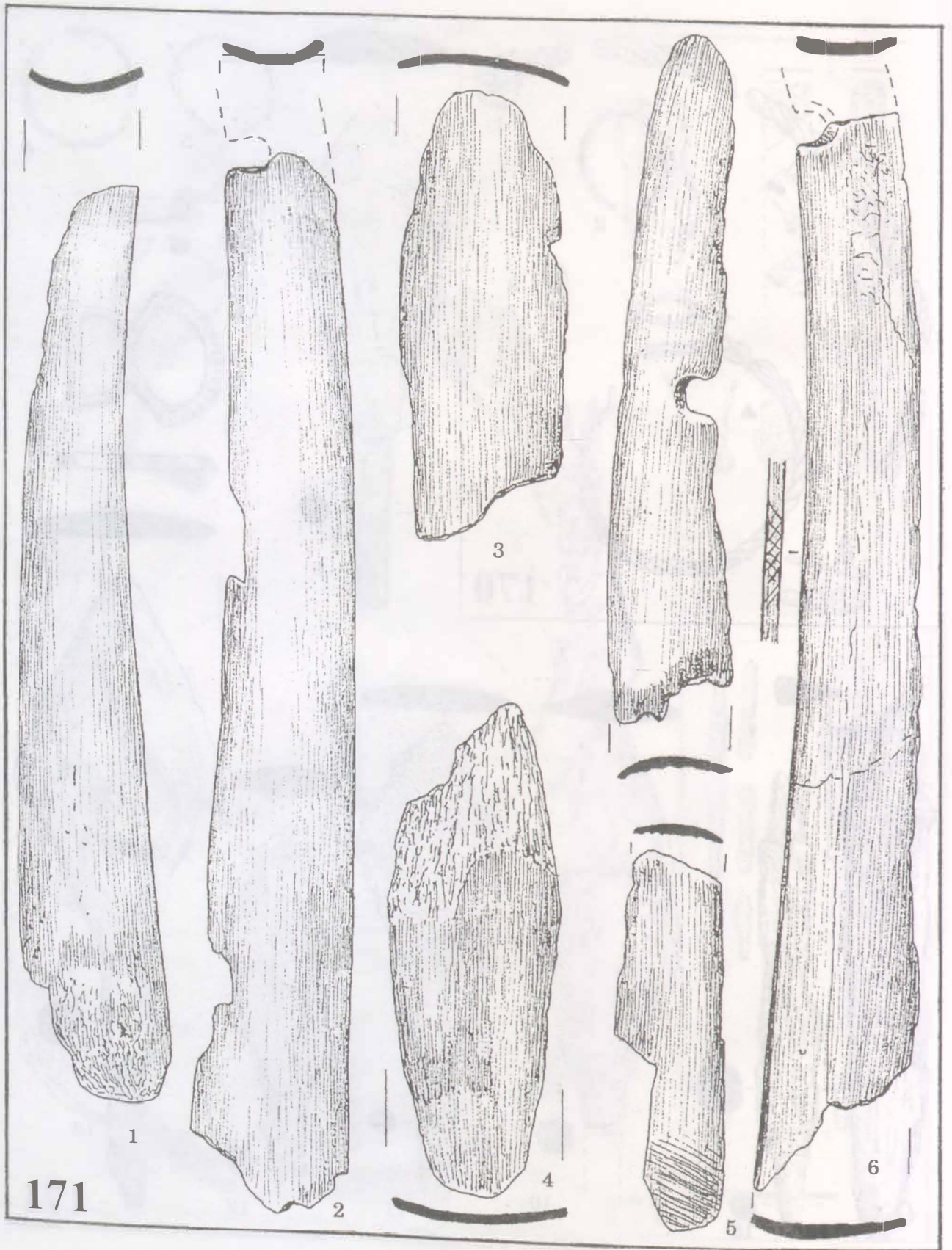

296. tábla: Sárrétudvari-Hízóföld. 171. sír (1:1)

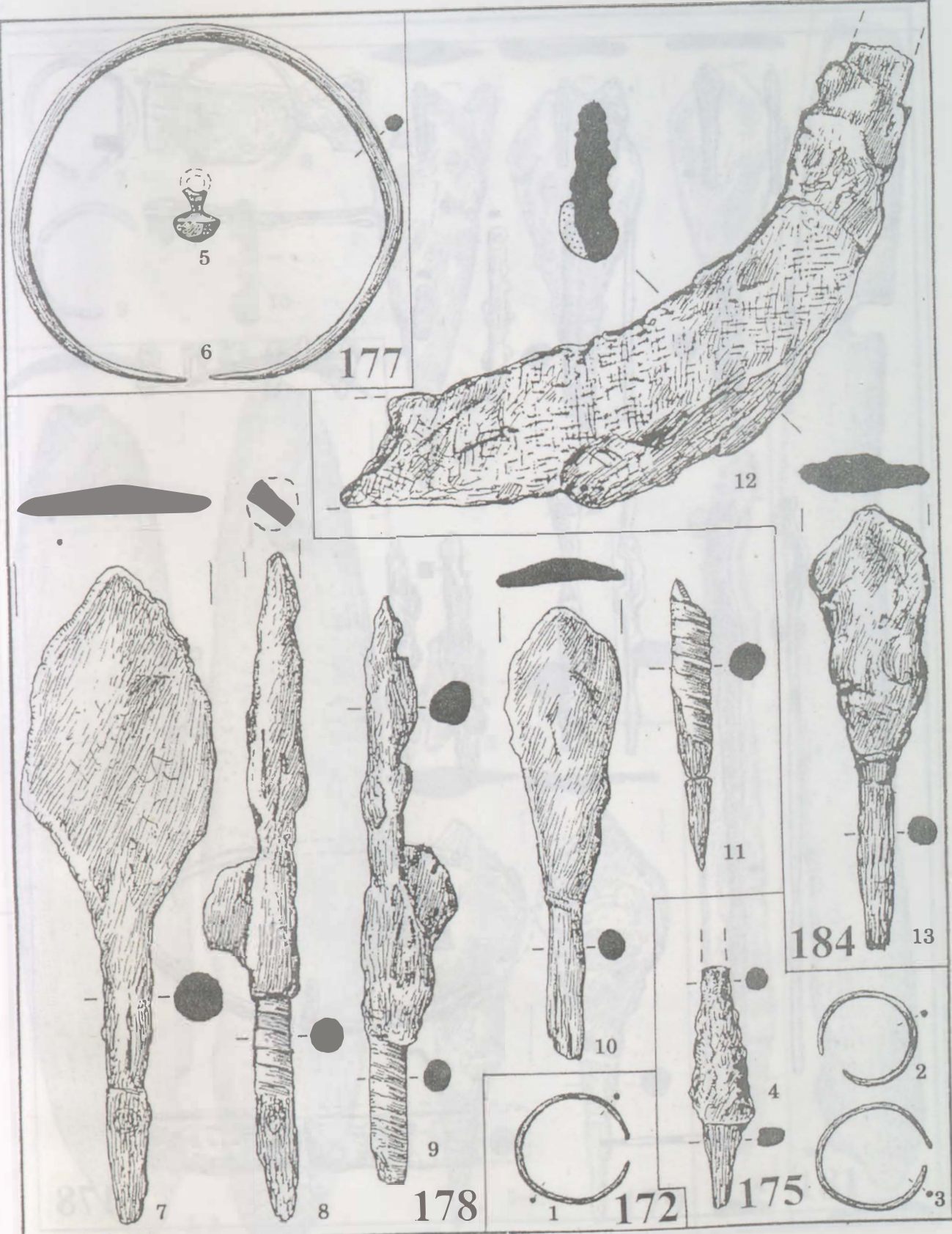

297. tábla: Sárrétudvari-Hízófold. 172., 175., 177-178., 184. sír (1:1)

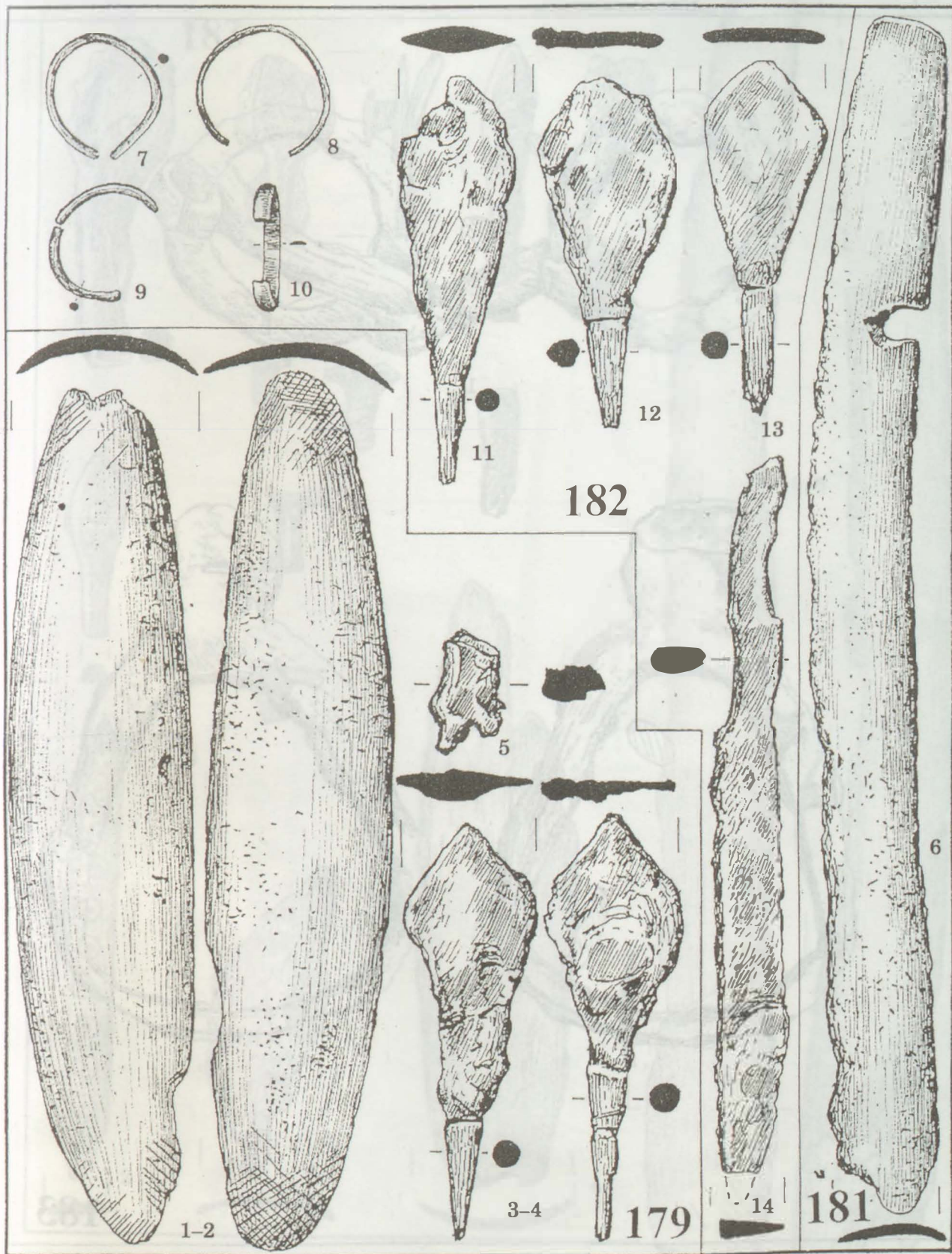

299. tábla: Sárrétudvari-Hízóföld. 179., 181–182. sír (1:1)

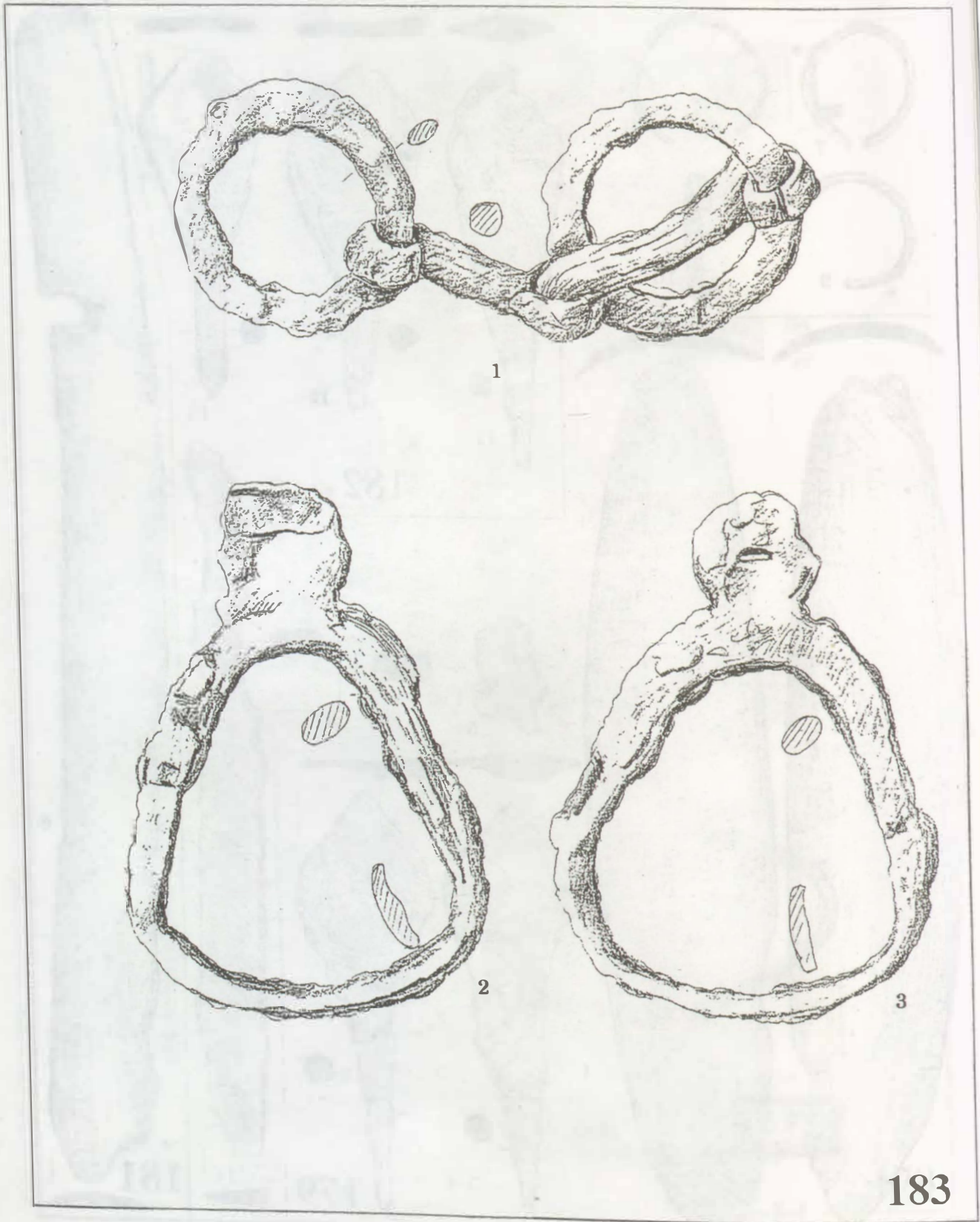

183

300. tábla: Sárrétudvari-Hízóföld. 183. sír (1:2)

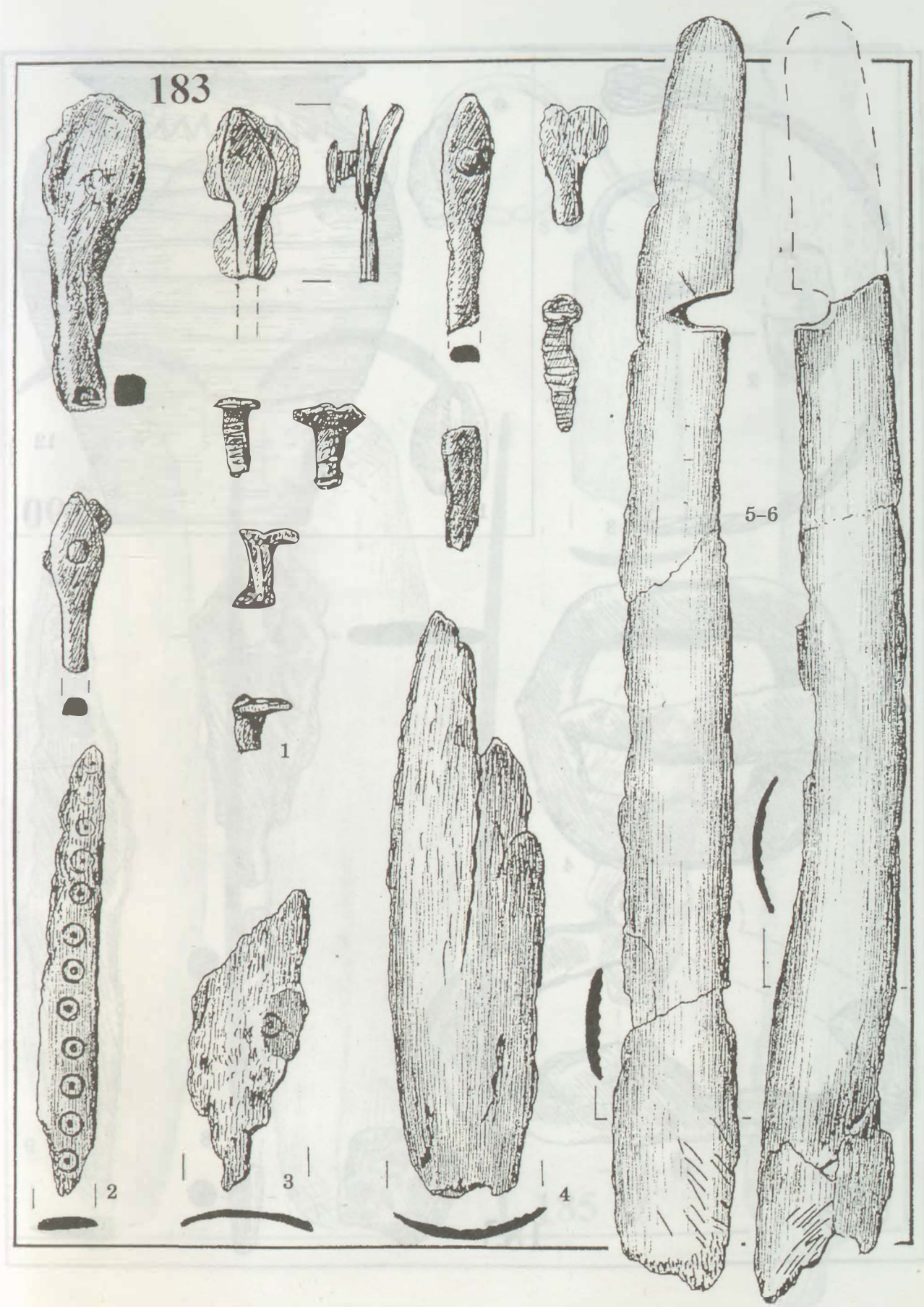

301. tábla: Sárrétudvari-Hízófold. 183. sír (1:1)

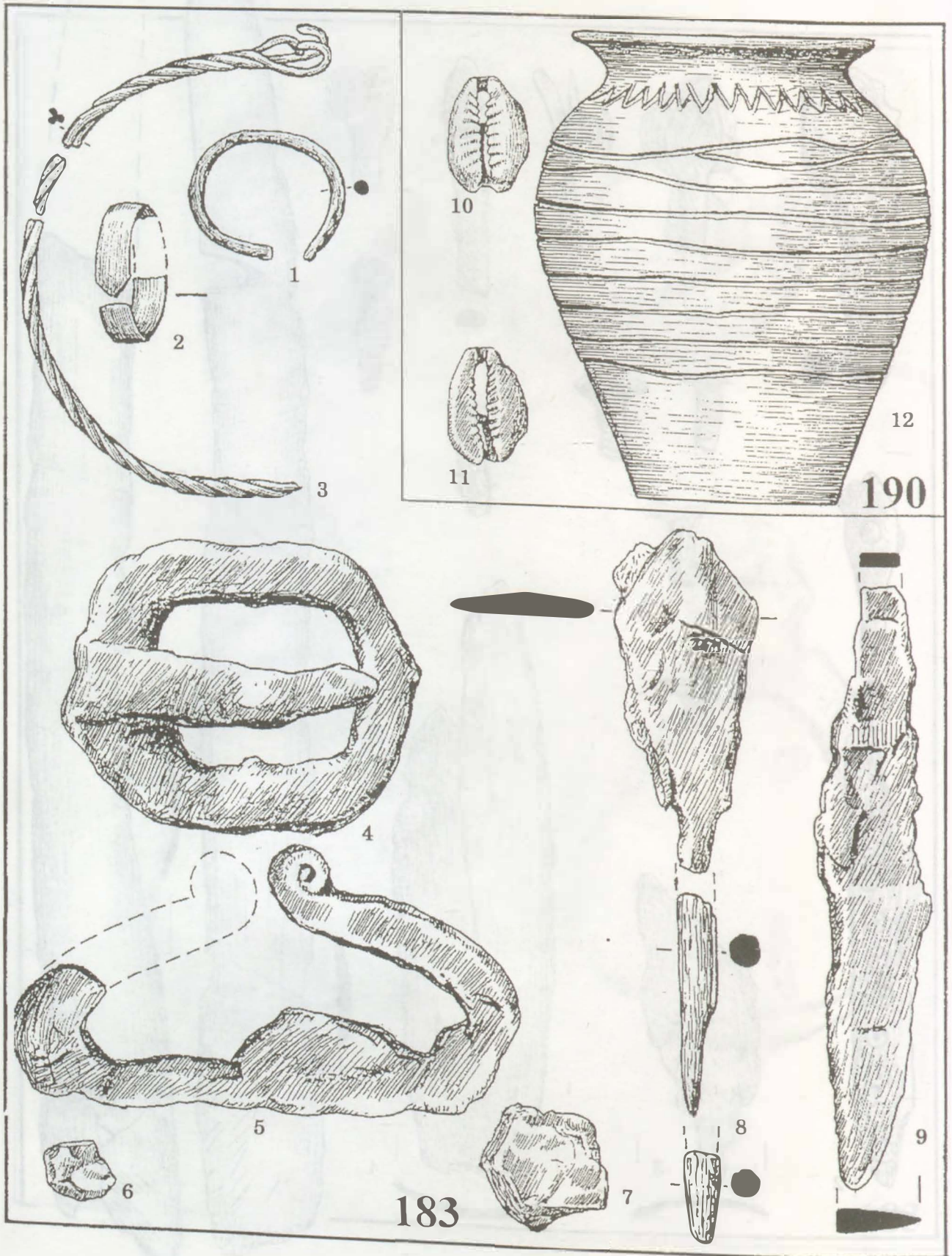

302. tábla: Sarrétudvari-Hízóföld. 183. sír (1:1), 190. sír (10–11. 1:1; 12. 1:2)

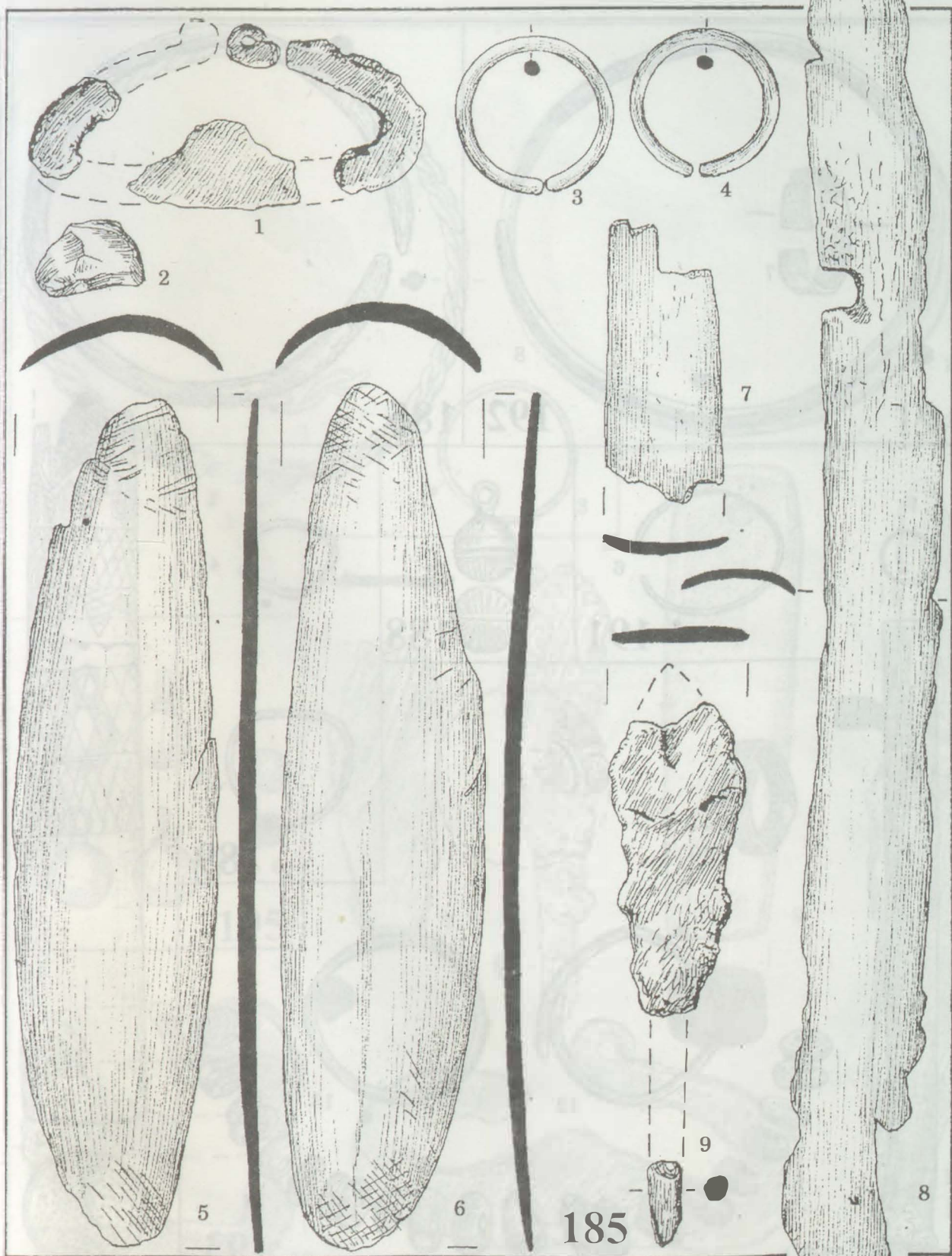

303. tábla: Sárrétudvari-Hízófold. 185. sír (1:1)

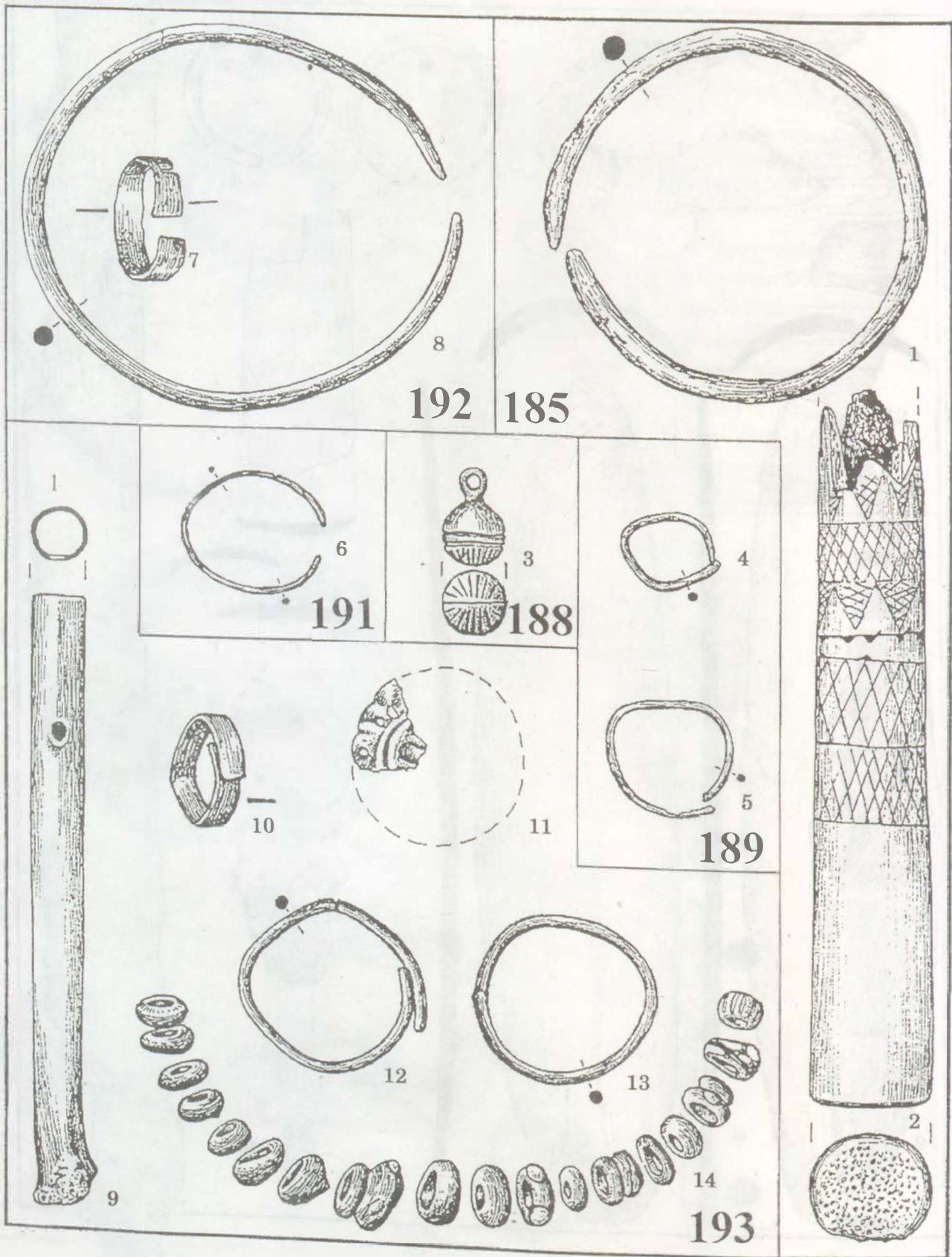

304. tábla: Sárretudvari-Hízófold. 185., 188–189., 191–193. sír (1:1)

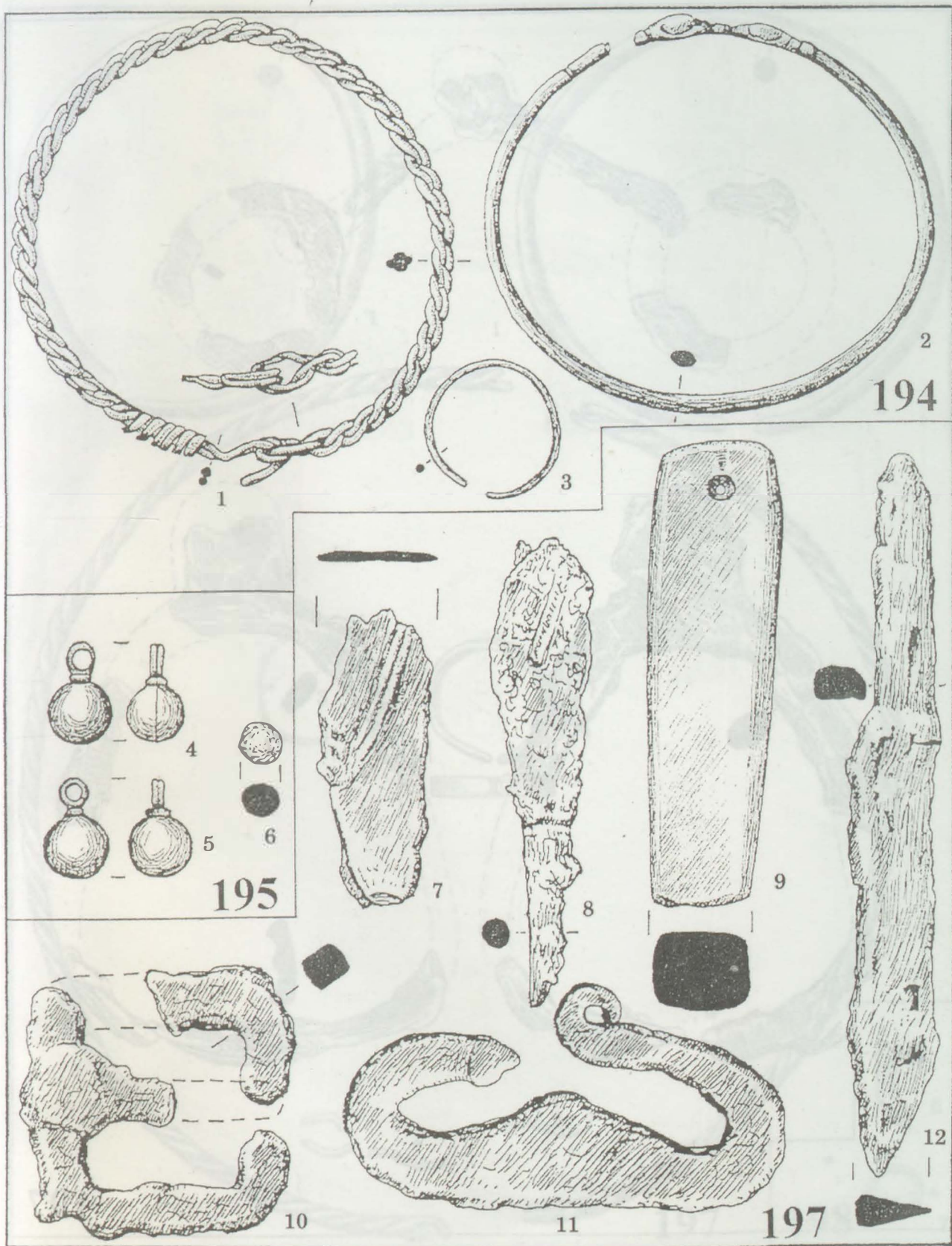

305. tábla: Sárrétudvari-Hízófold. 194-195., 197. sír (1:1)

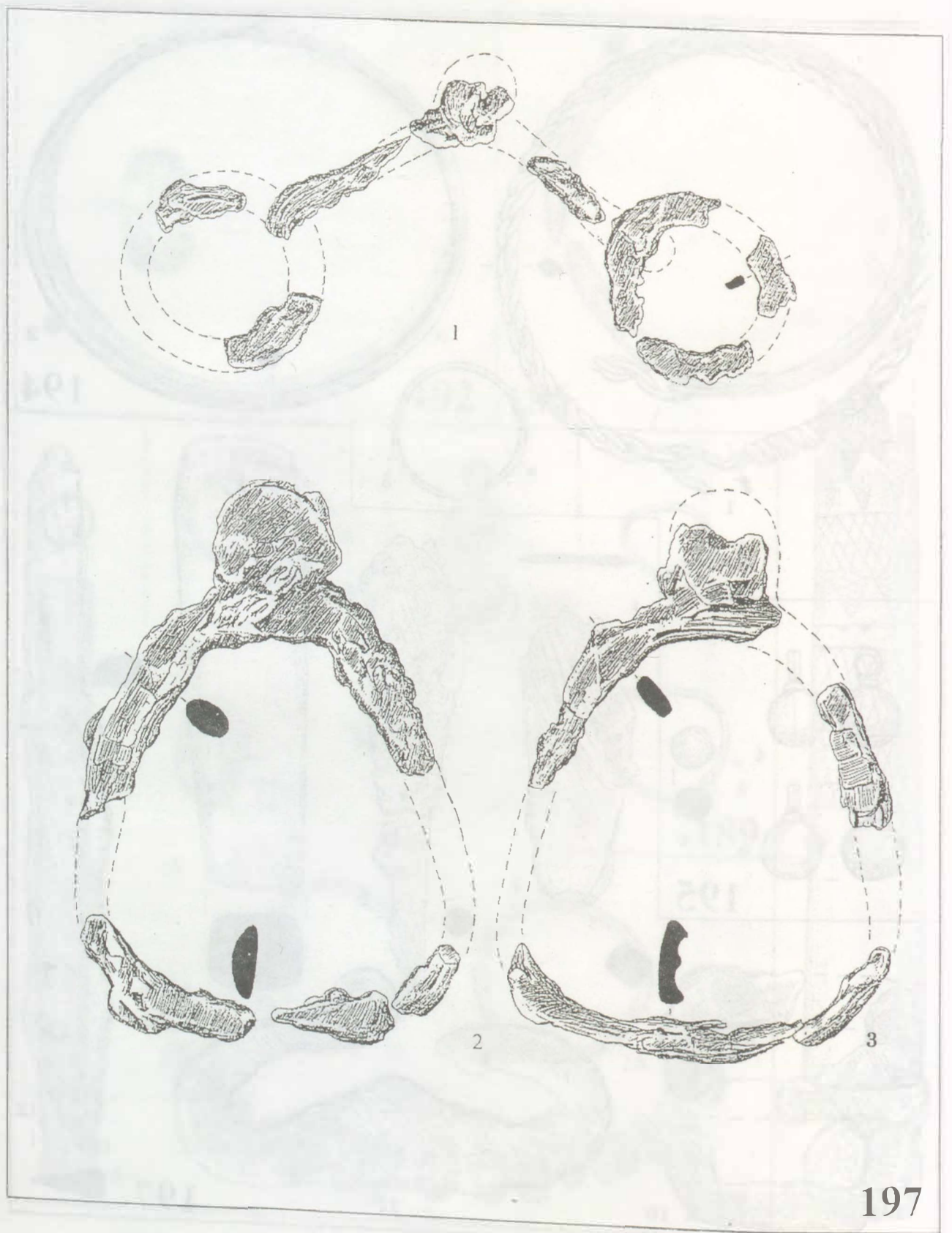

197

306. tábla: Sárrétudvari-Hízóföld. 197. sír (1:2)

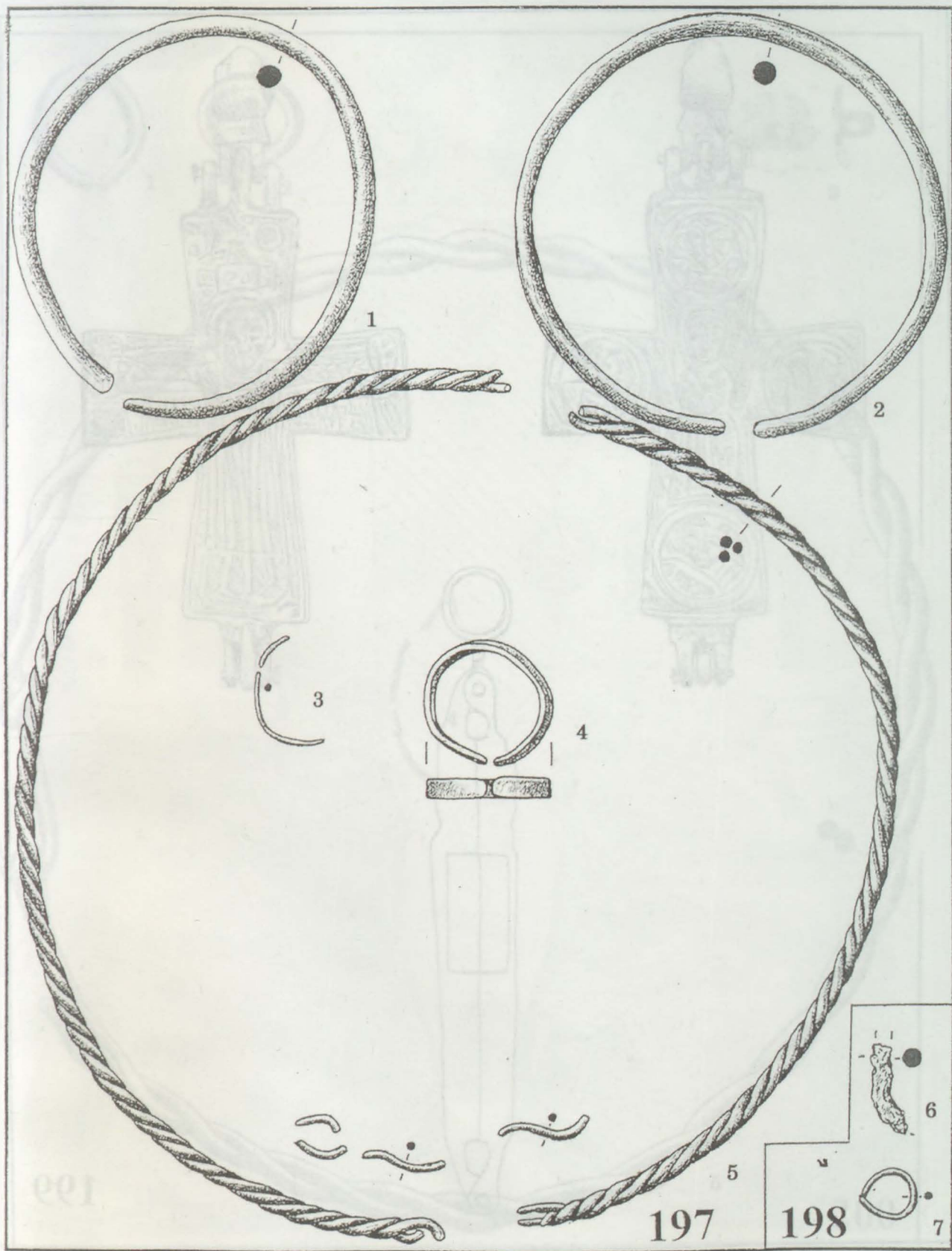

307. tábla: Sárrétudvari-Hízóföld. 197–198. sír (1:1)

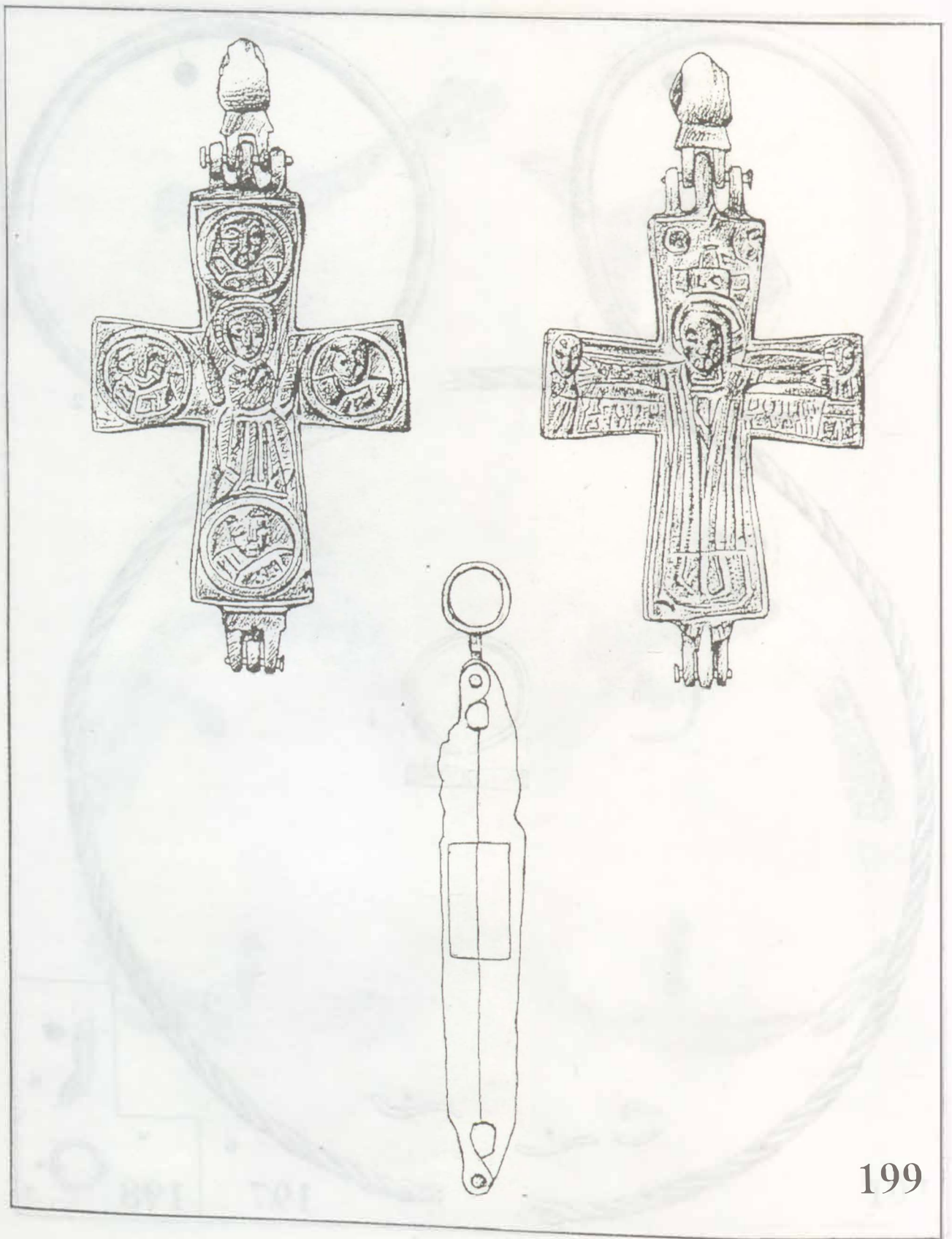

199

308. tábla: Sárrétudvari-Hízófold. 199. sír (1:1)

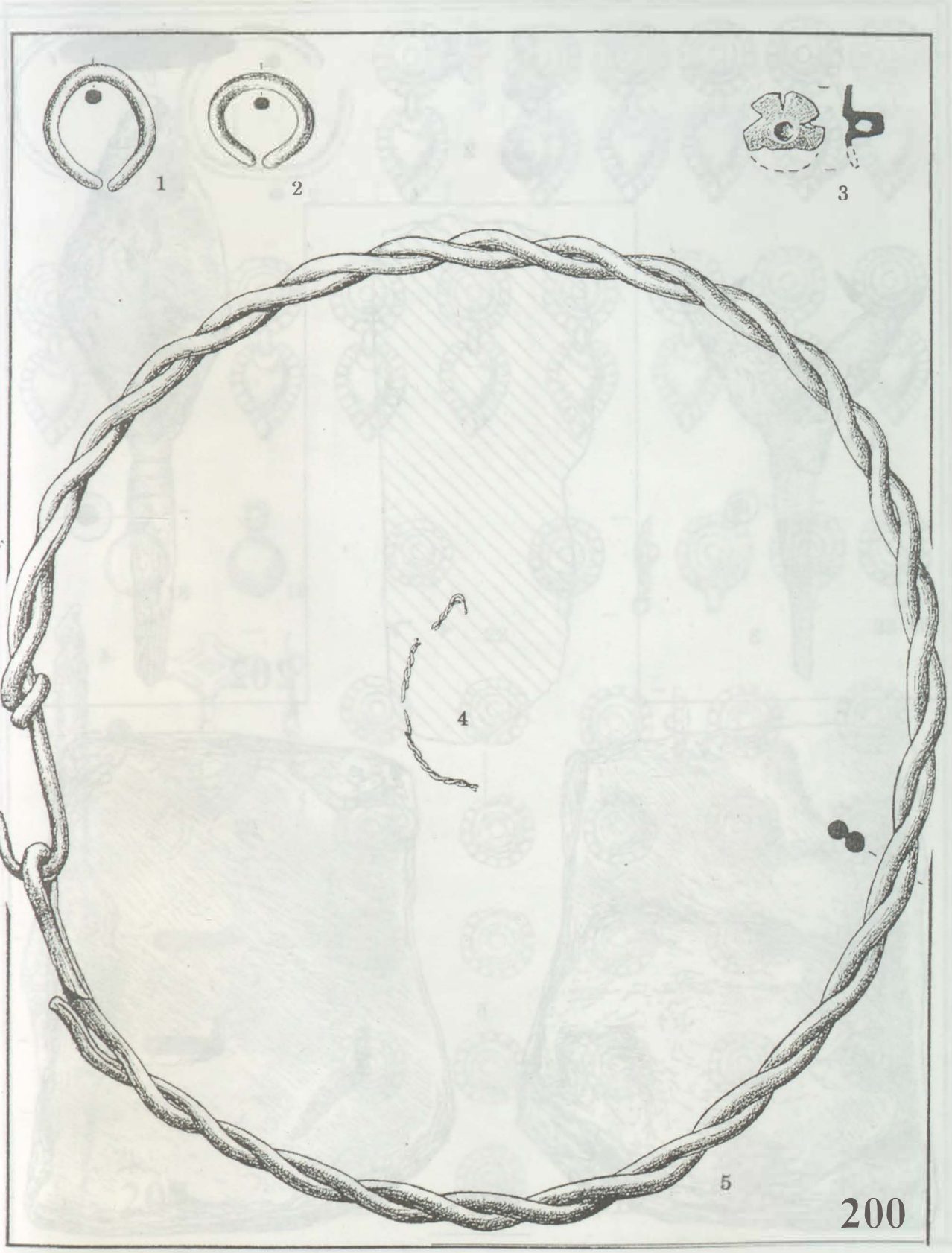

309. tábla: Sárrétudvari-Hízóföld. 200. sír (1:1)

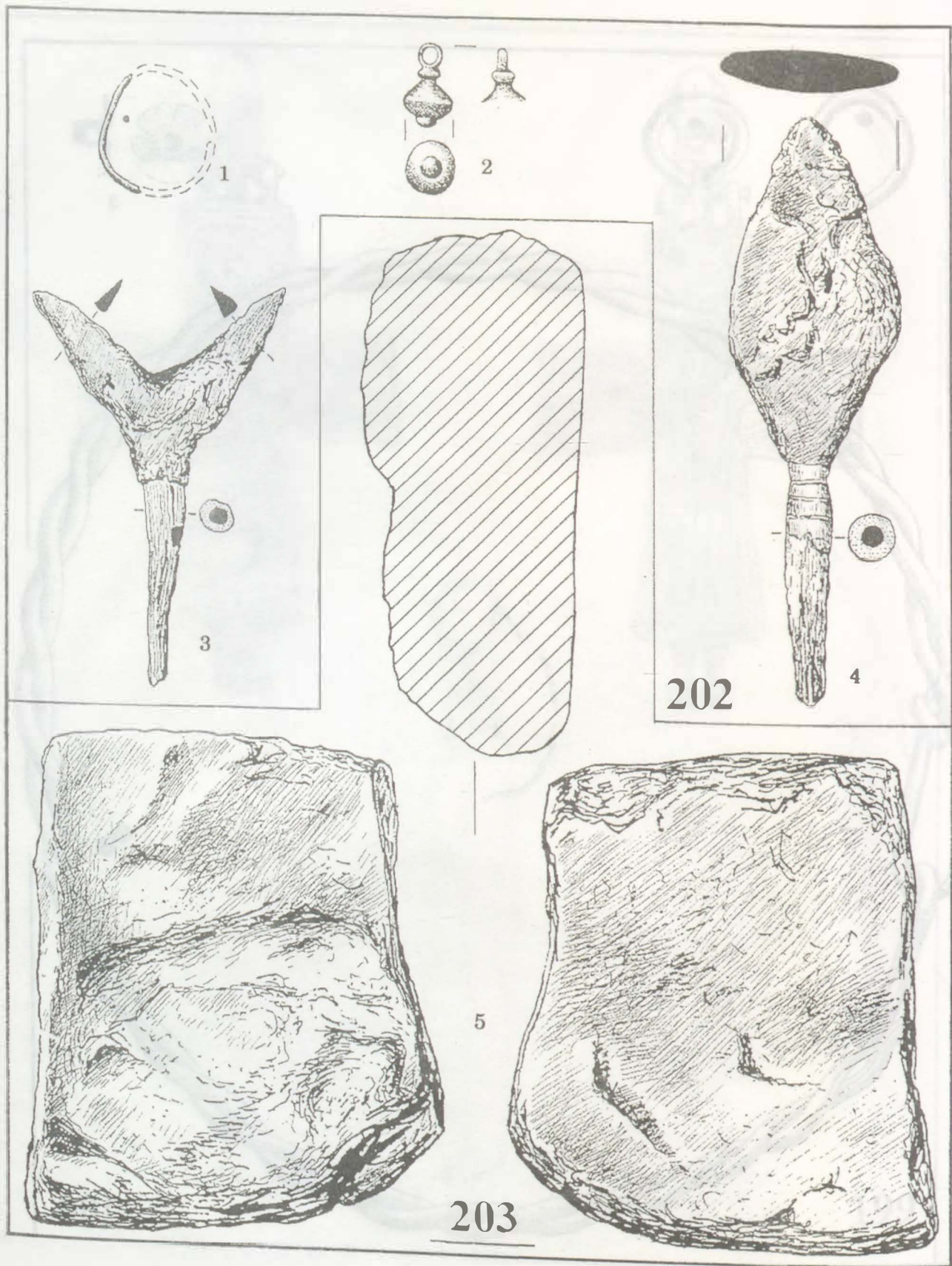

310. tábla: Sárretudvari-Hízófold. 202–203. sír (1:1)

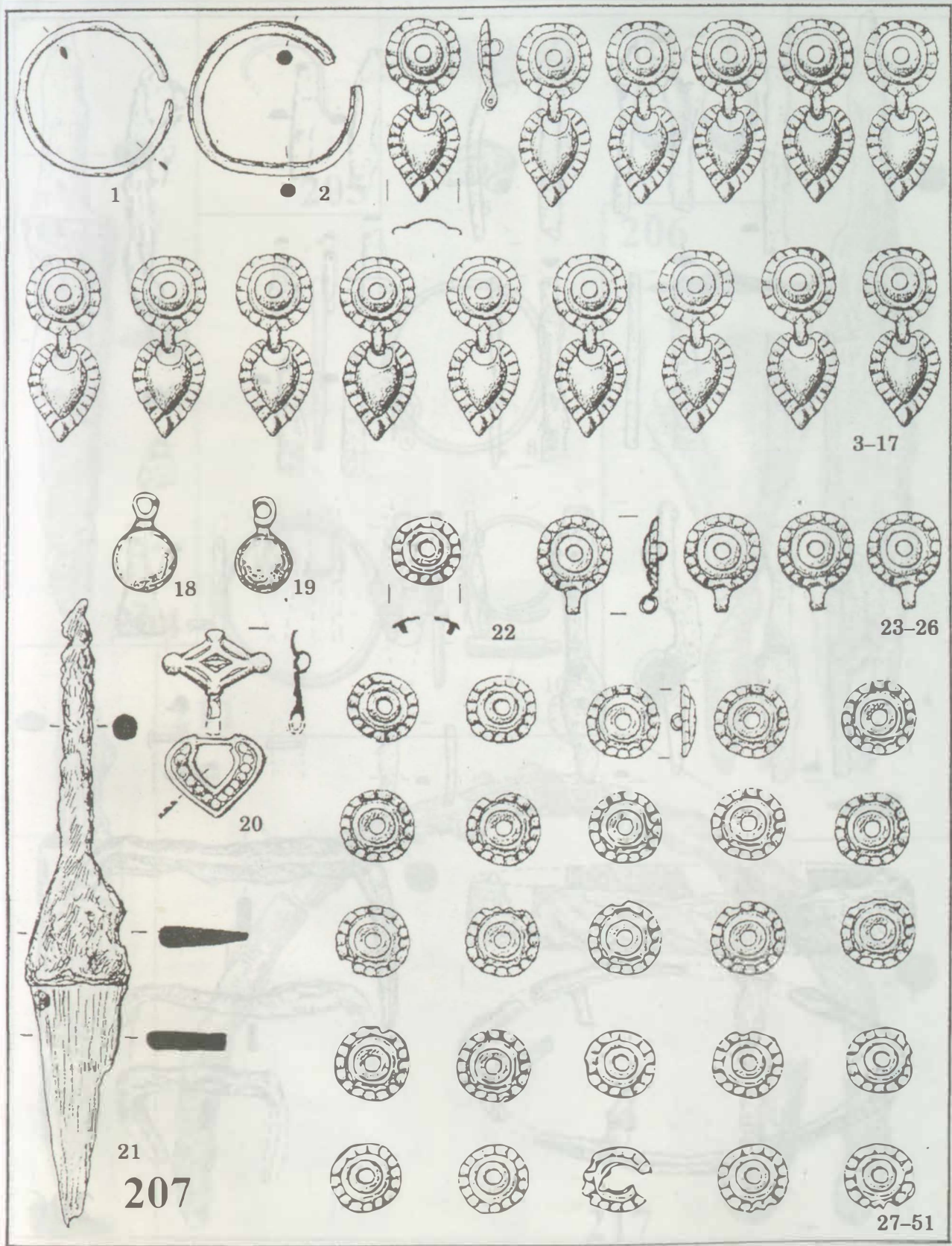

311. tábla: Sárretudvari-Hízófold. 207. sír (1:1)

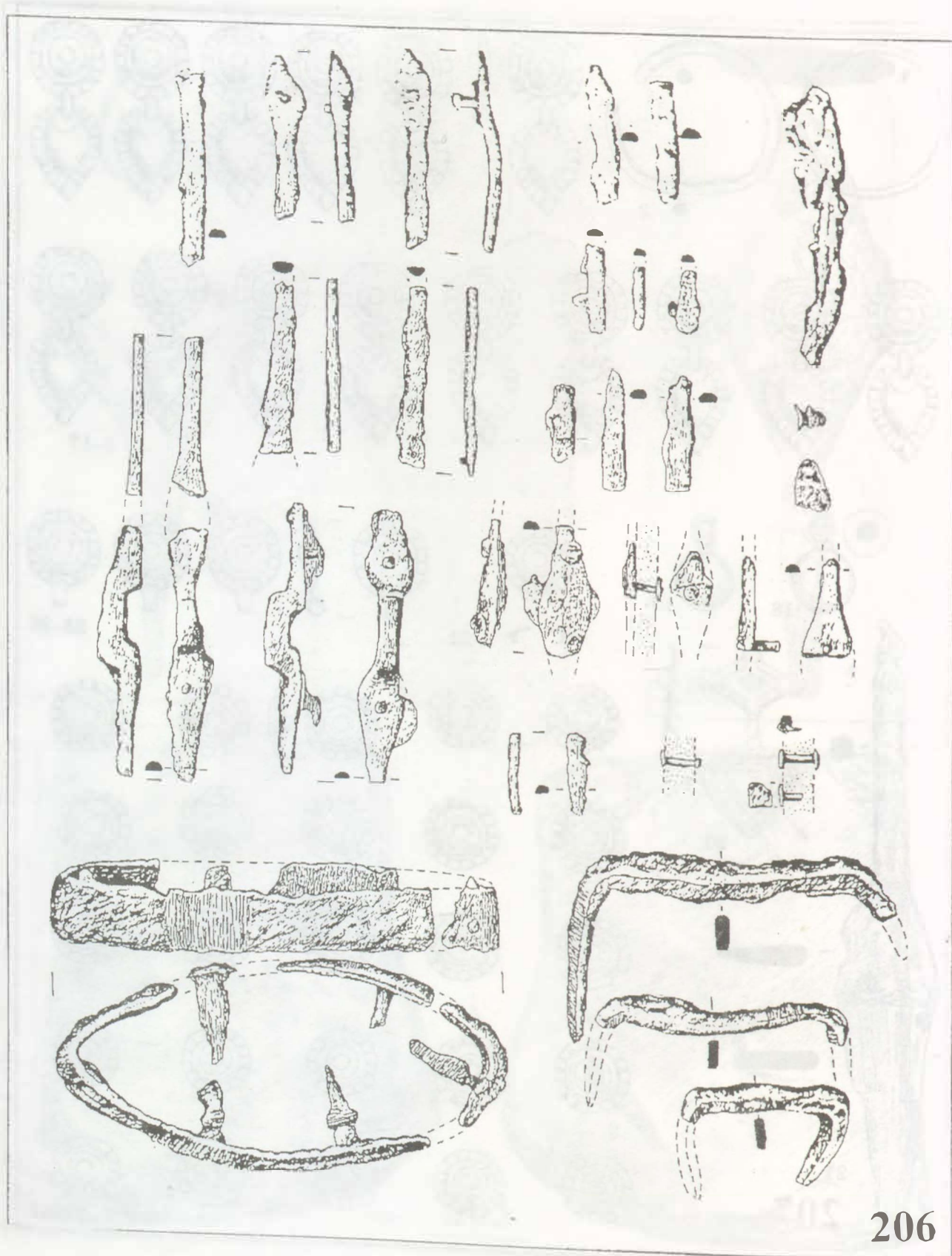

312. tábla: Sárretudvari-Hízófold. 206. sír (1:2)

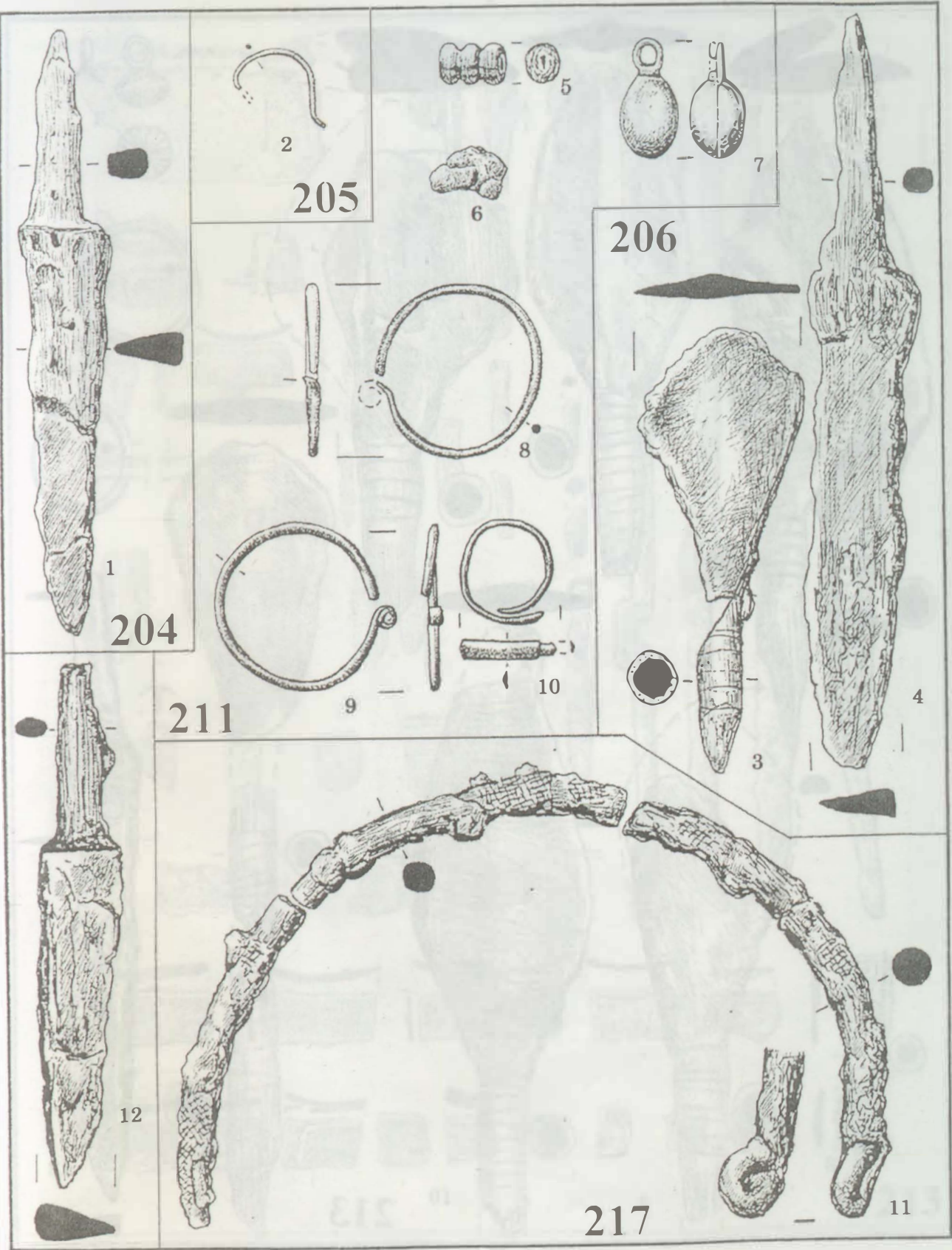

313. tábla: Sárretudvari-Hízófold. 204–206., 211., 217. sír (1:1)

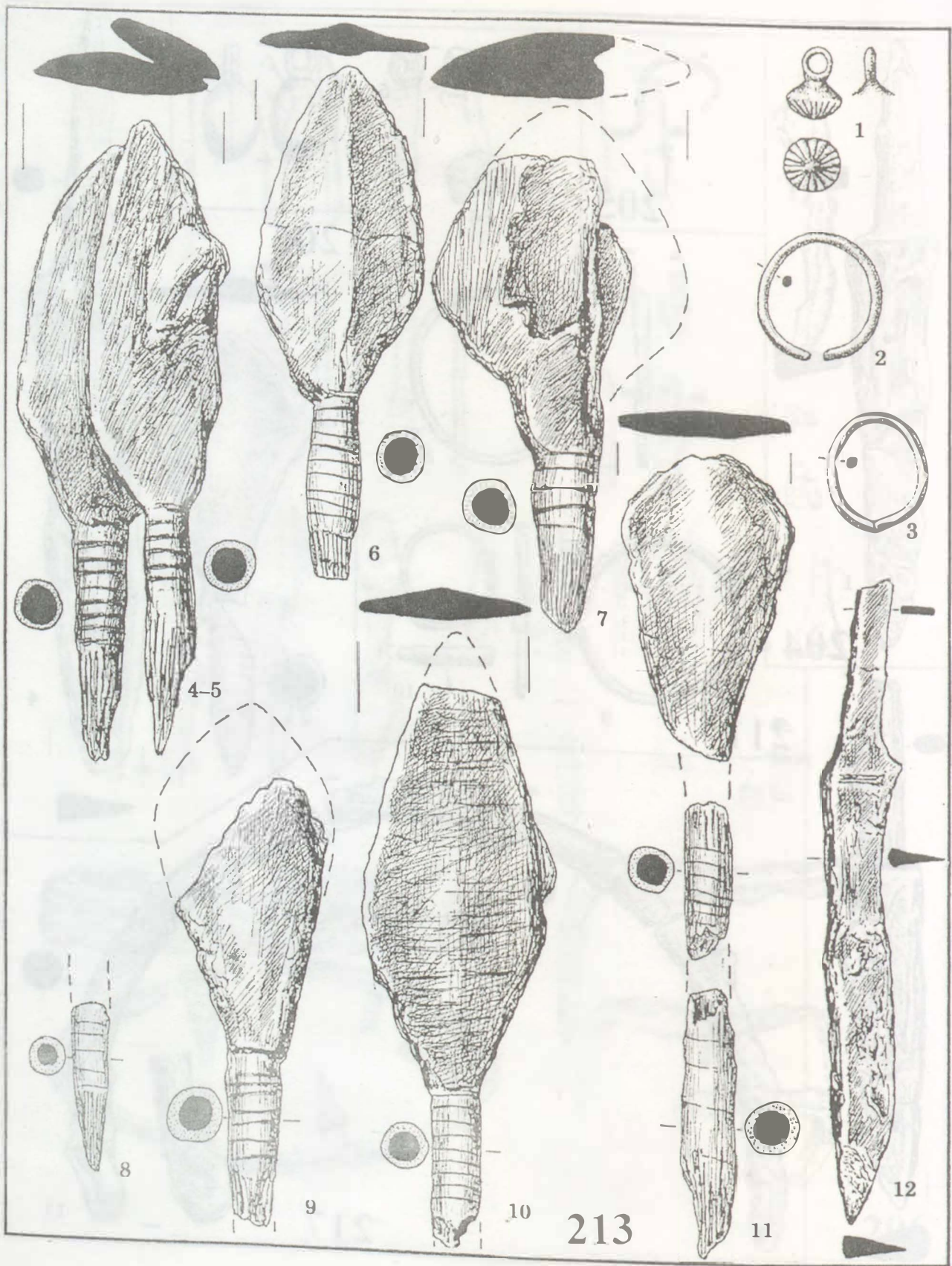

314. tábla: Sárrétudvari-Hízófold. 213. sír (1:1)



213

315. tábla: Sárrétudvari-Hízóföld. 213. sír (1:2)

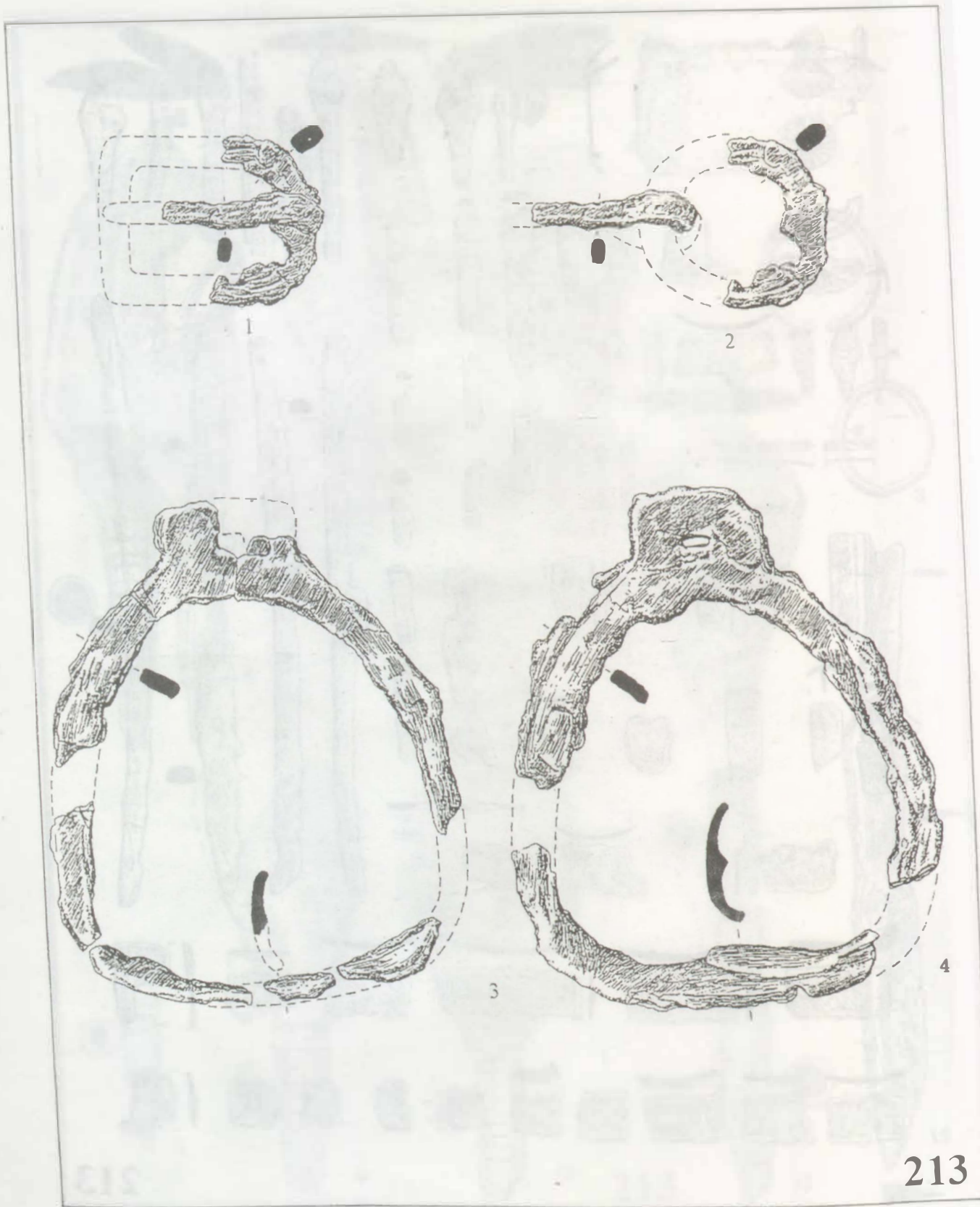

316. tábla: Sárretudvari-Hízóföld. 213. sír (1:2)

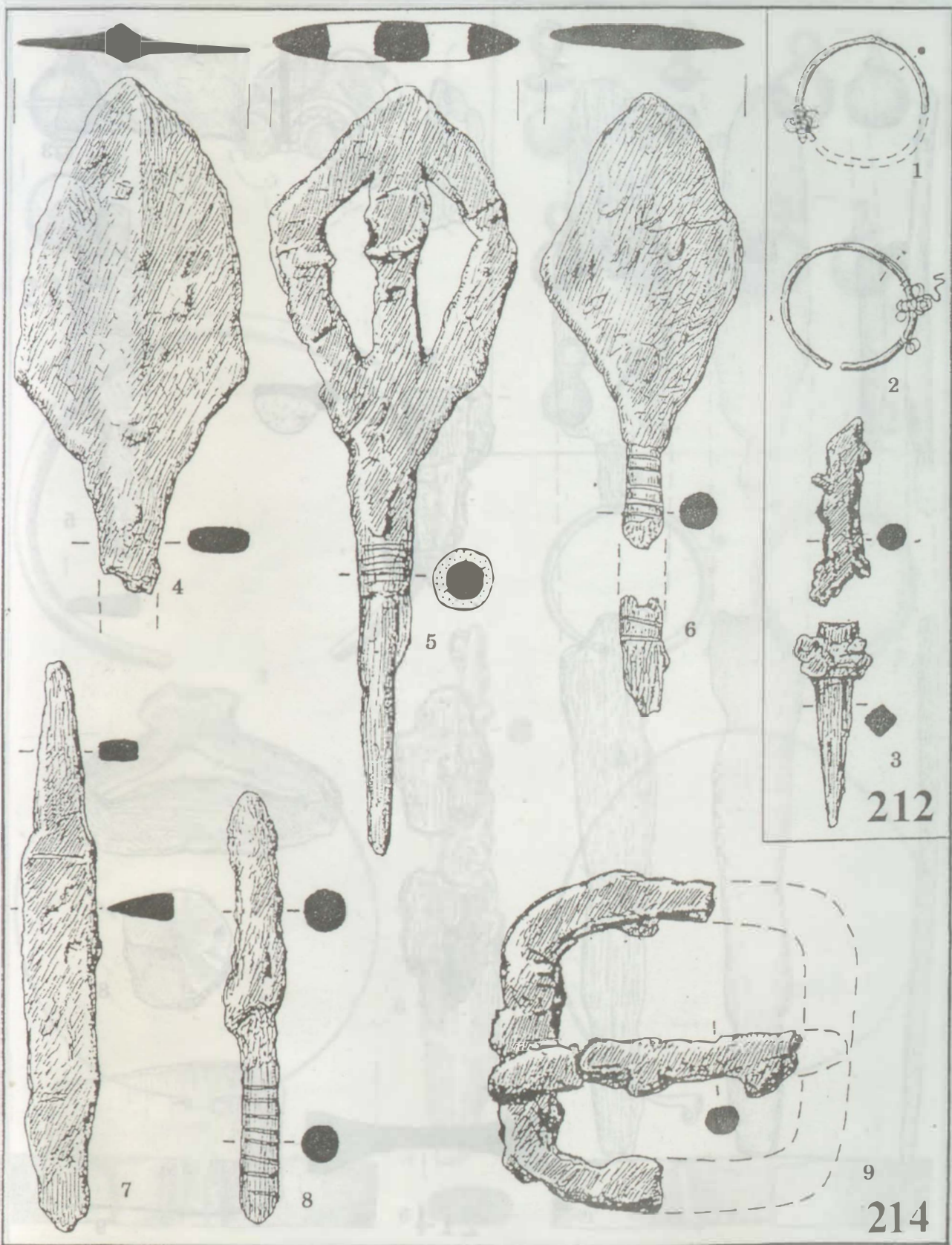

317. tábla: Sárrétudvari-Hízóföld. 212., 214. sír (1:1)

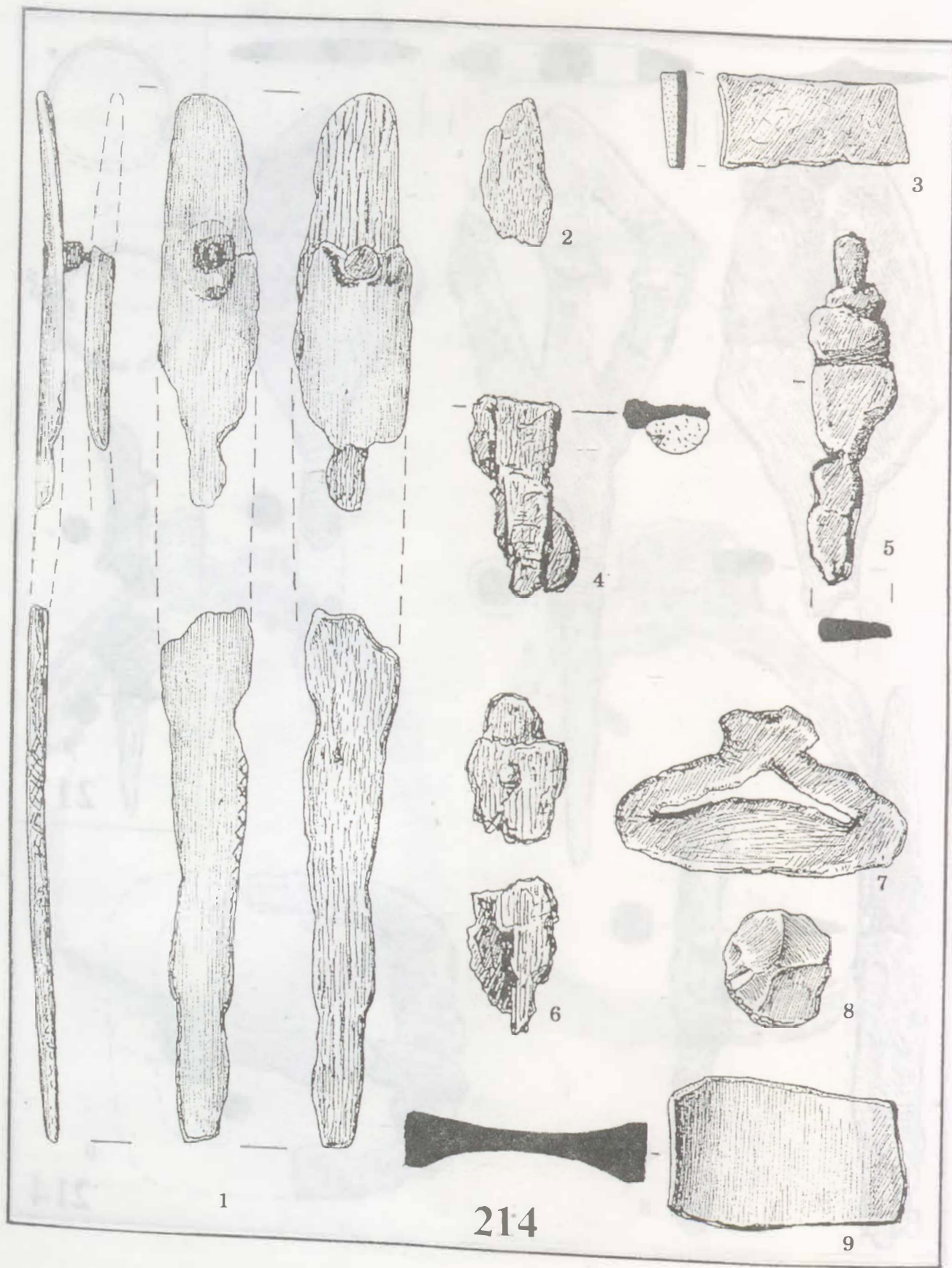

318. tábla: Sárrétudvari-Hízóföld. 214. sír (1:1)

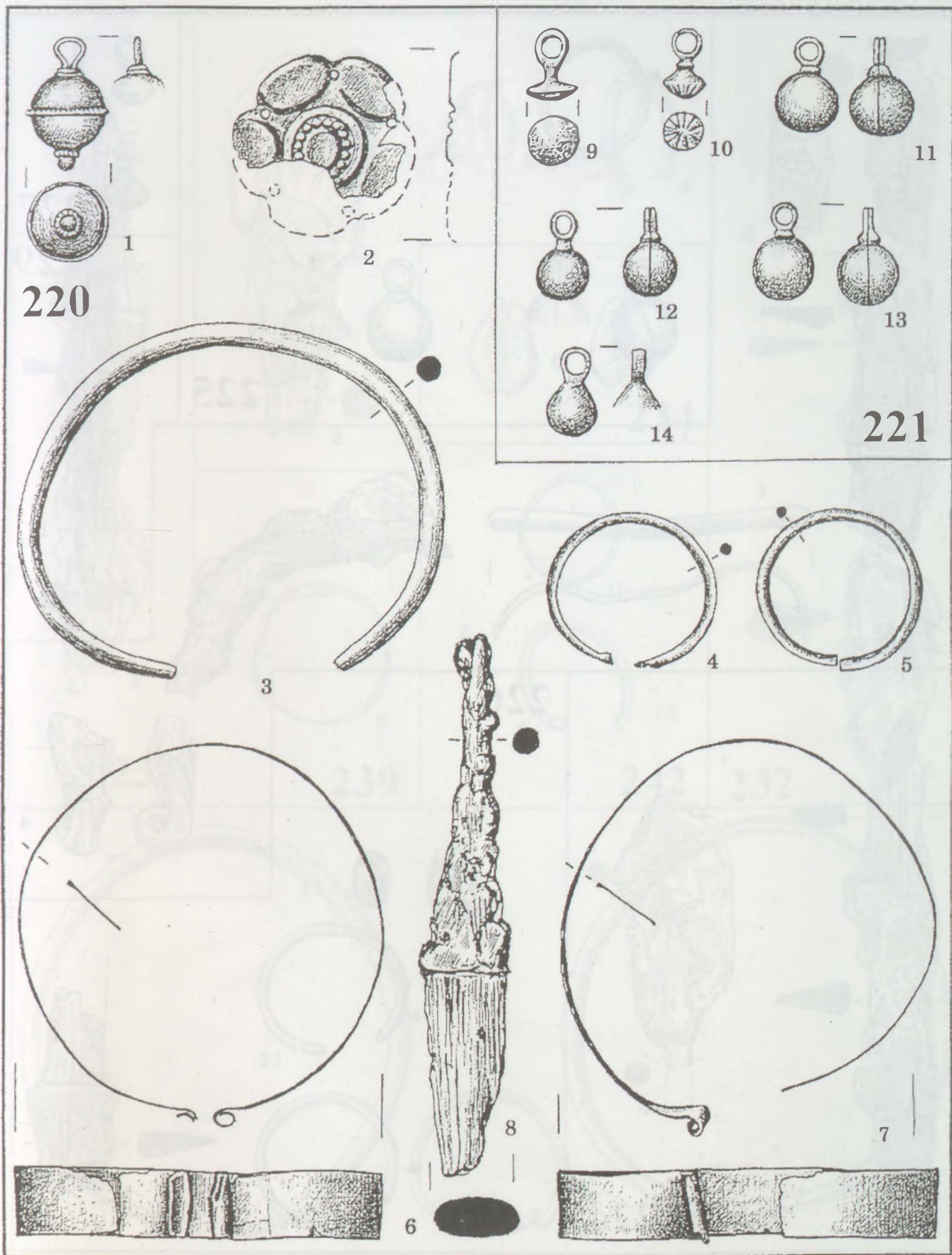

319. tábla: Sárretudvari-Hízófold. 220–221. sír (1:1)

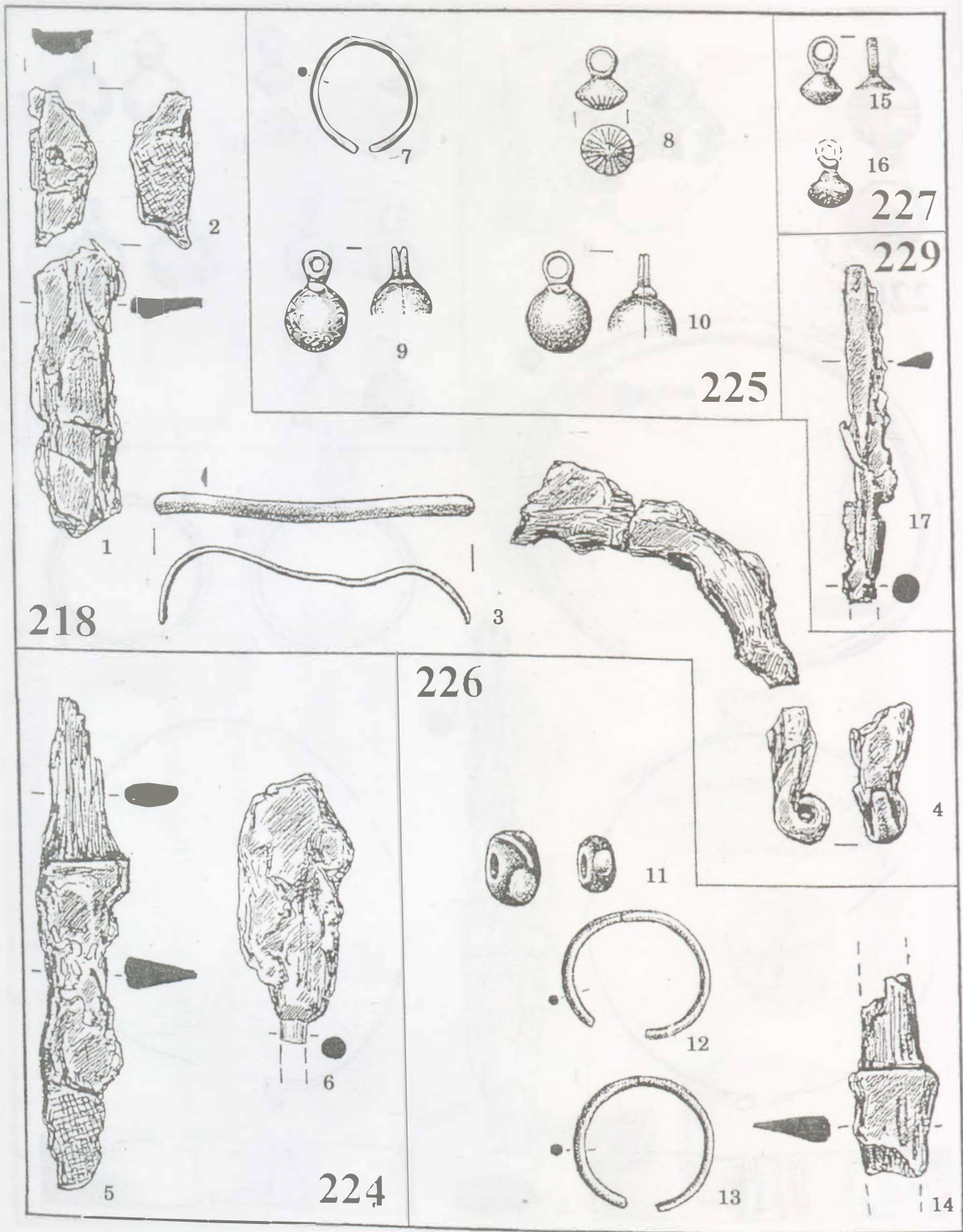

320. tábla: Sárrétudvari-Hízóföld. 218., 224–227., 229. sír (1:1)

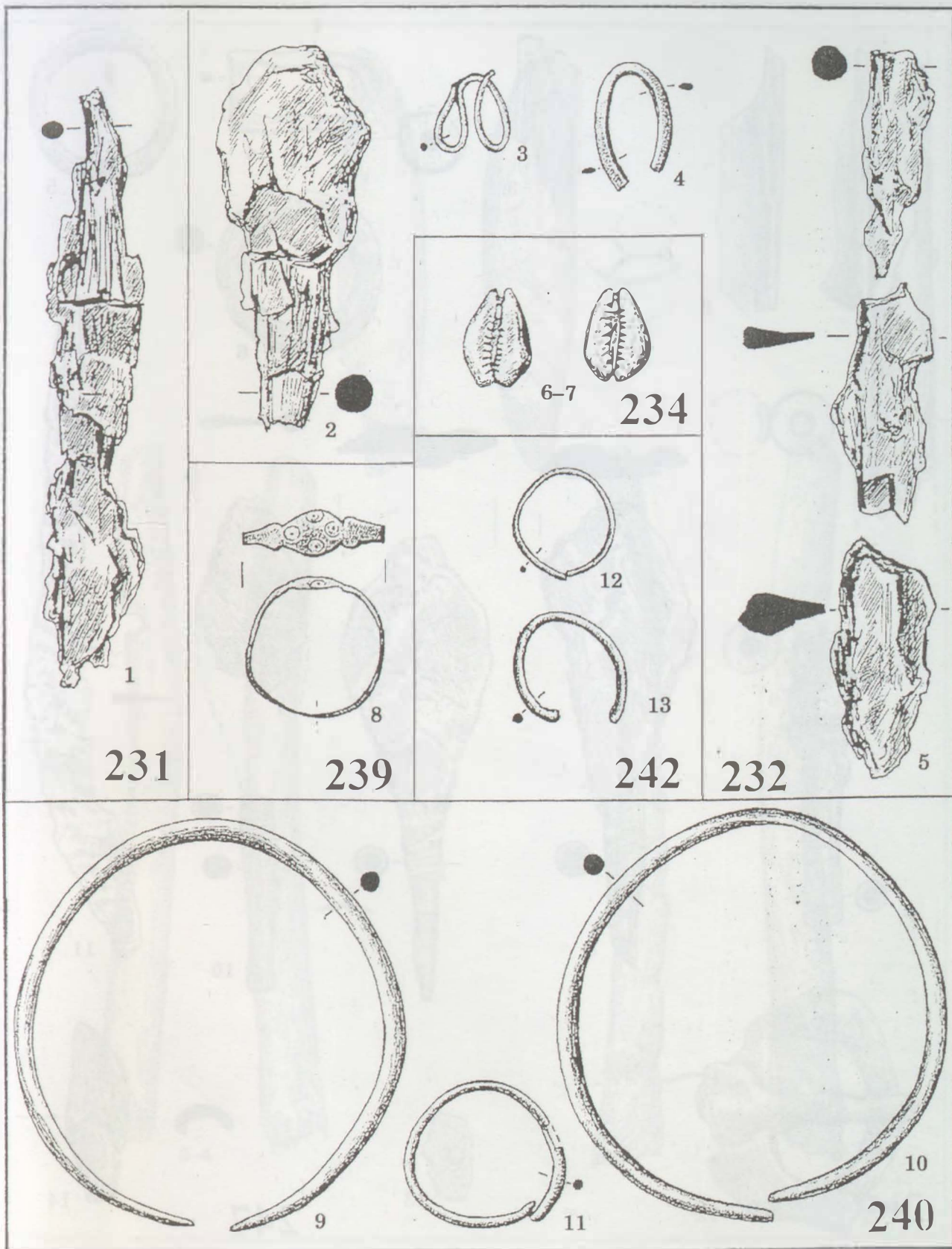

321. tábla: Sárrétudvari-Hízófold. 231-232., 234., 239-240., 242. sír (1:1)

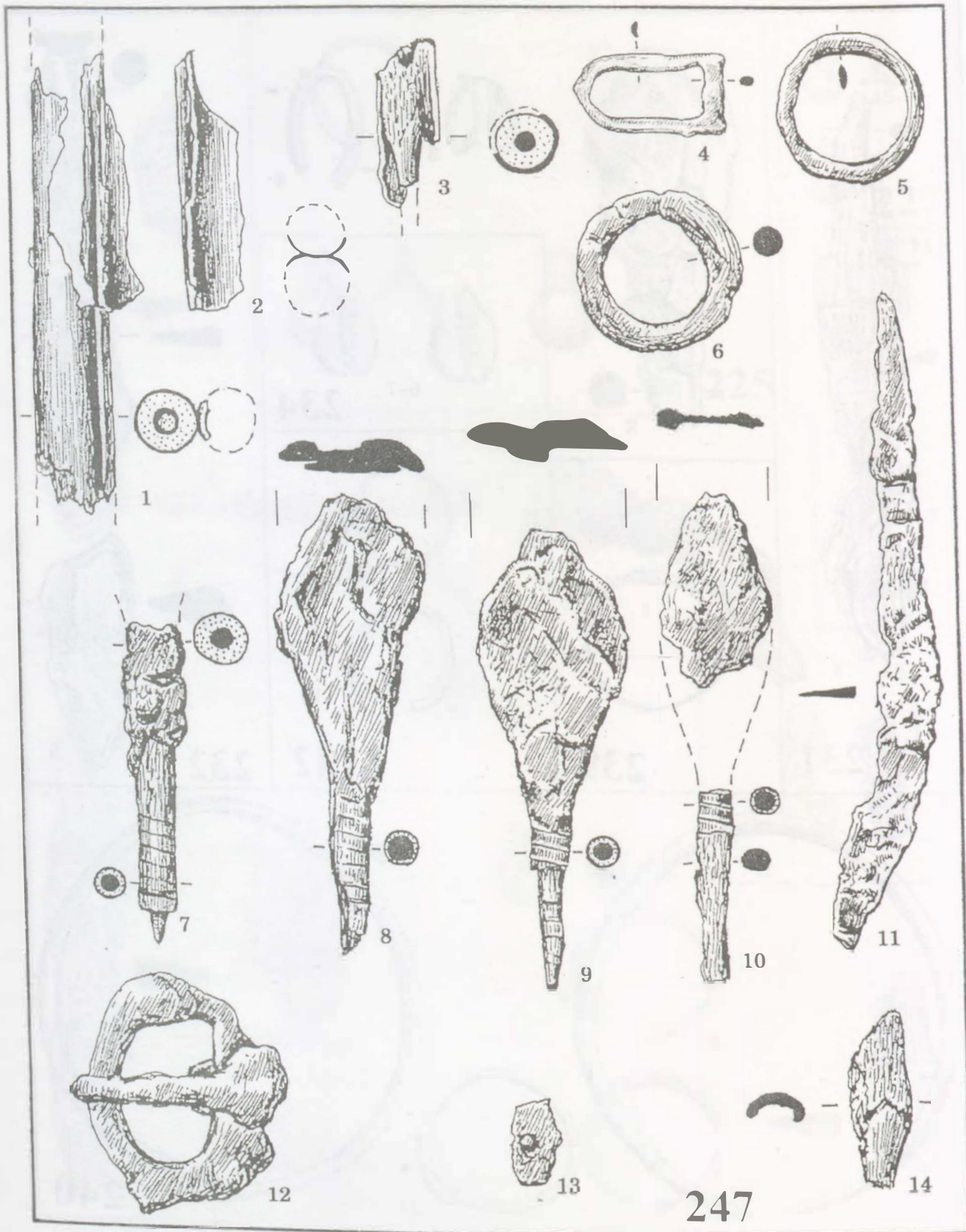

322. tábla: Sárrétudvari-Hízóföld. 247. sír (1:1)

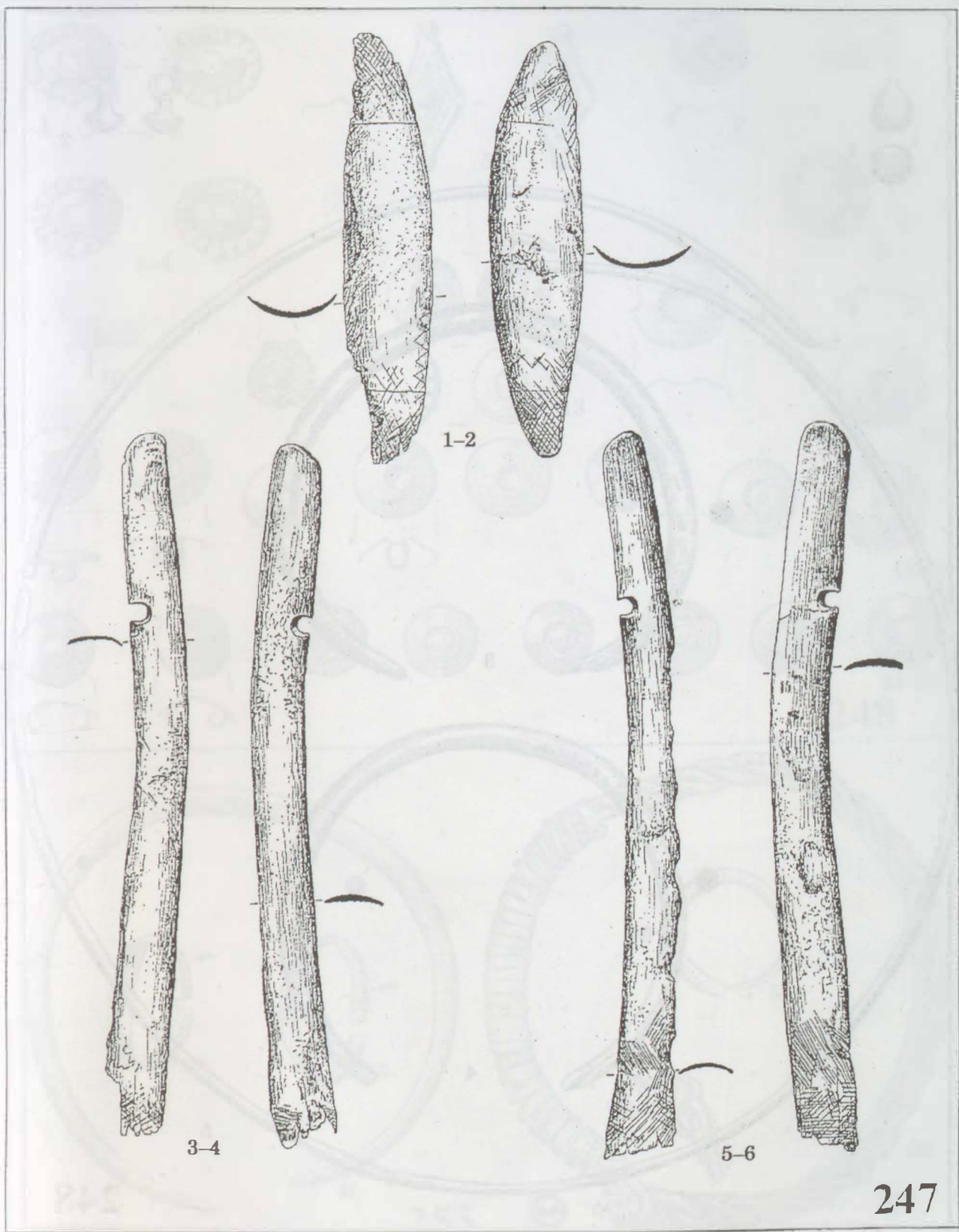

247

323. tábla: Sárretudvari-Hízófold. 247. sír (1:2)

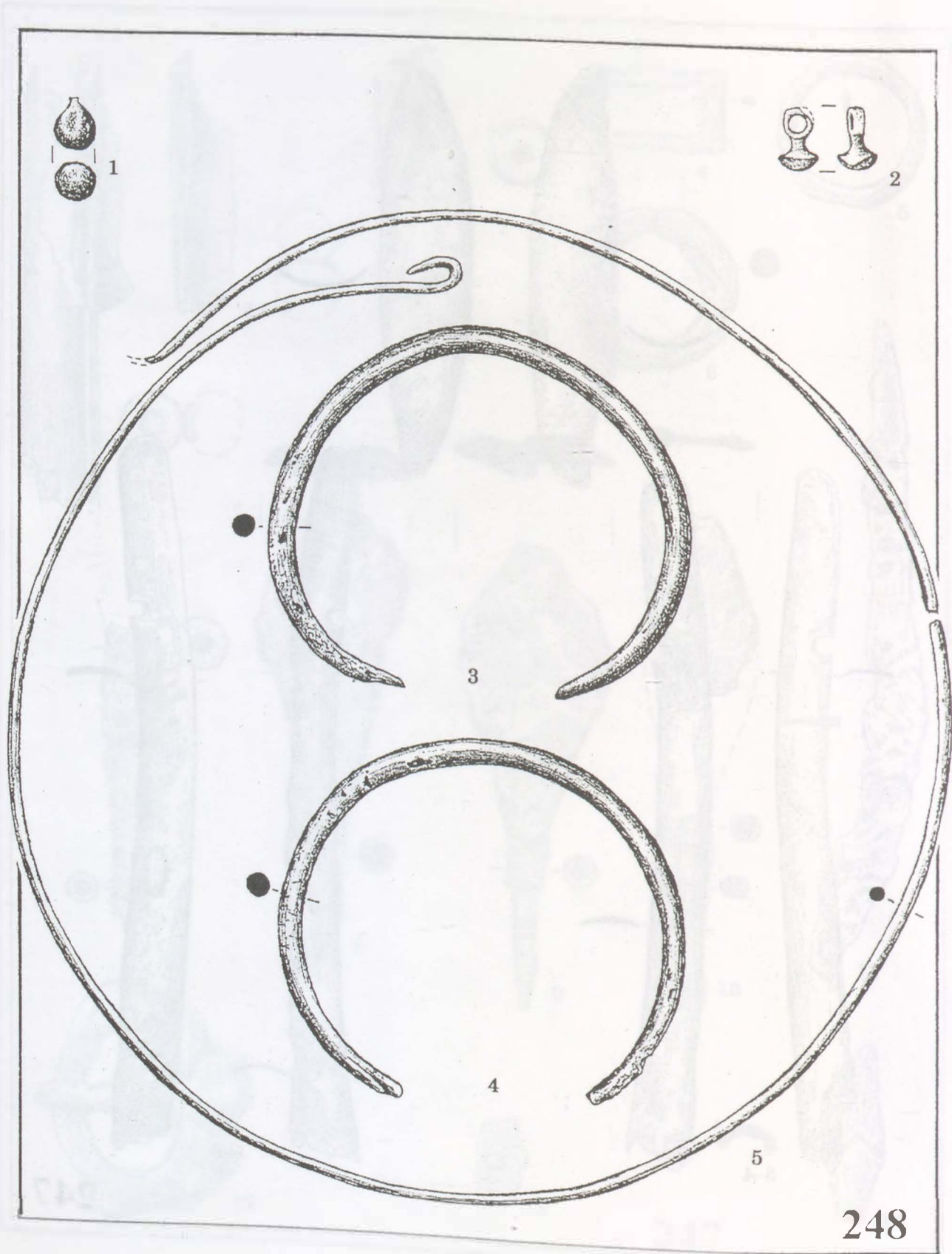

248

324. tábla: Sárrétudvari-Hízóföld. 248. sír (1:1)

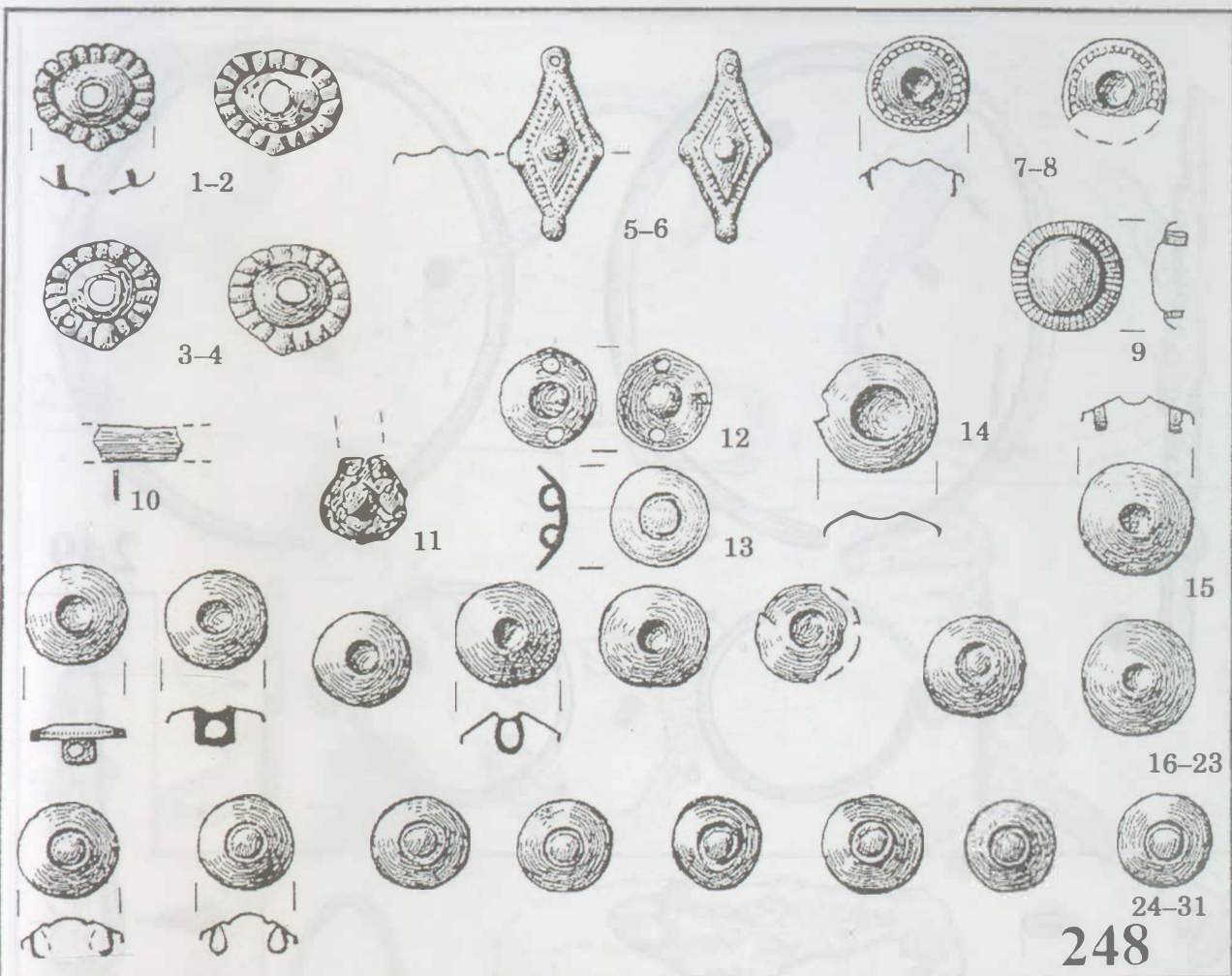

248

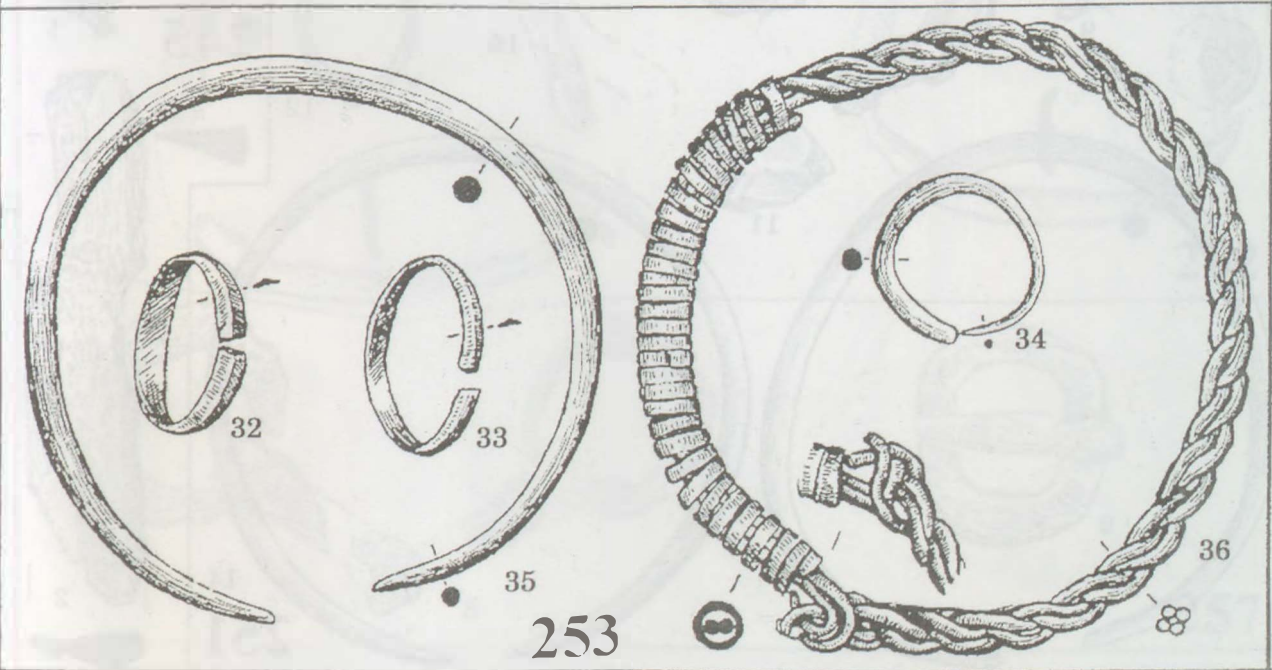

253

325. tábla: Sárrétudvari-Hízóföld. 248., 253. sír (1:1)

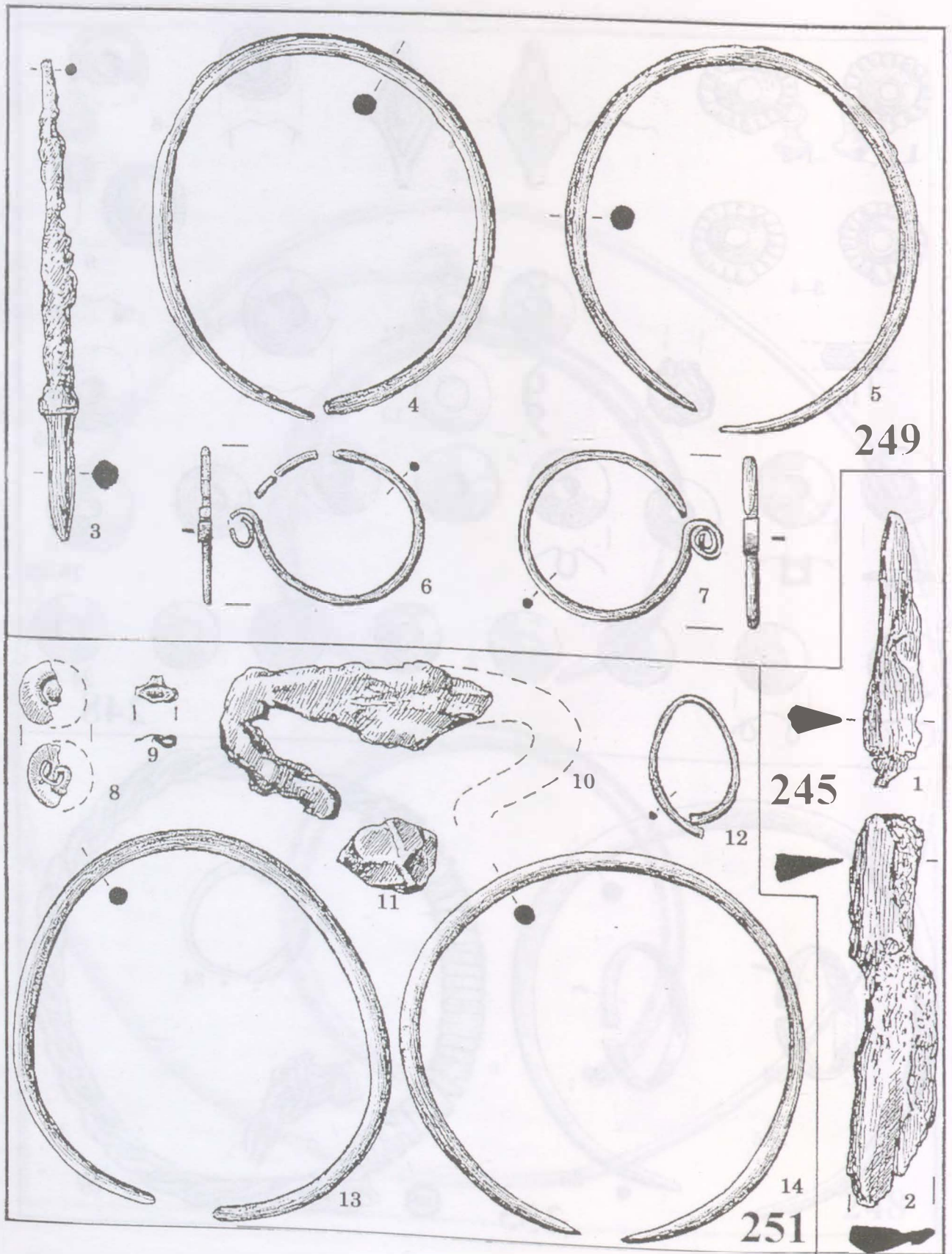

326. tábla: Sárrétudvari-Hízófold. 245., 249., 251. sír (1:1)

251

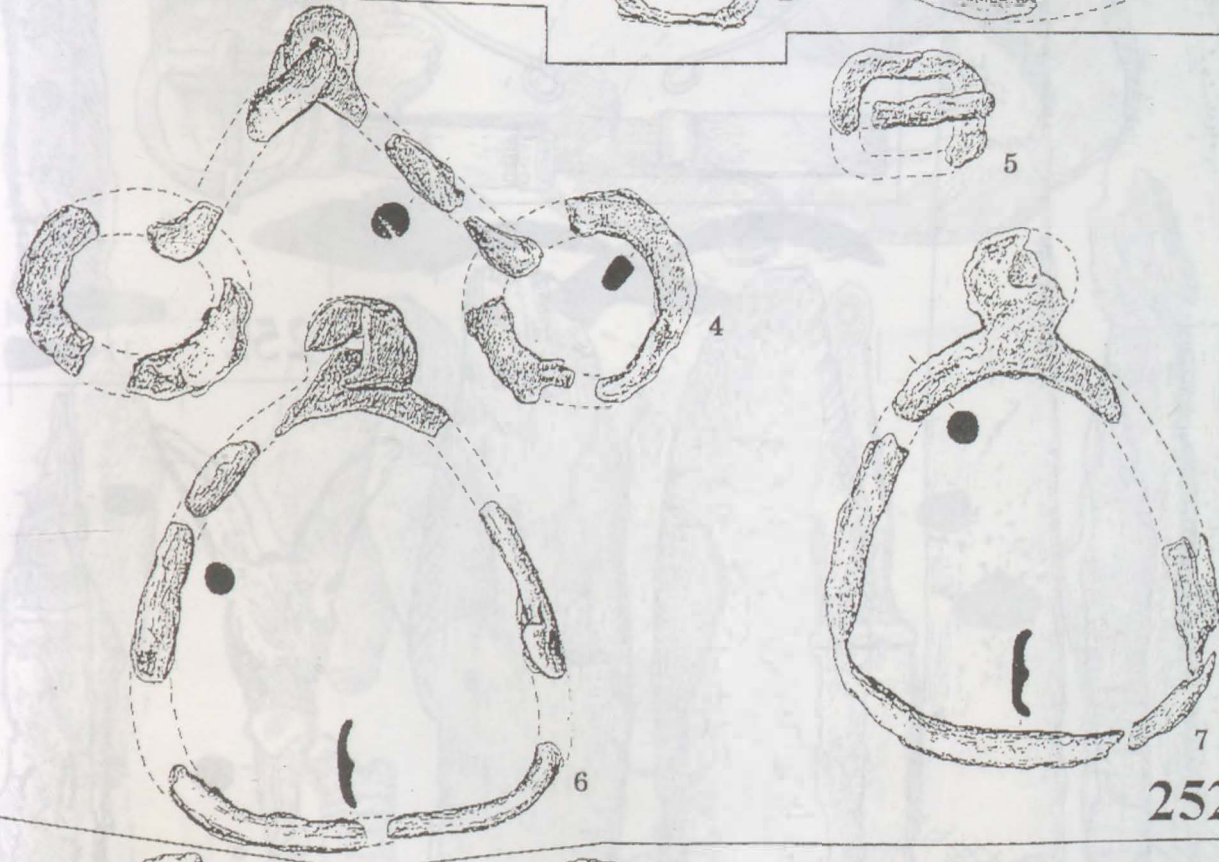
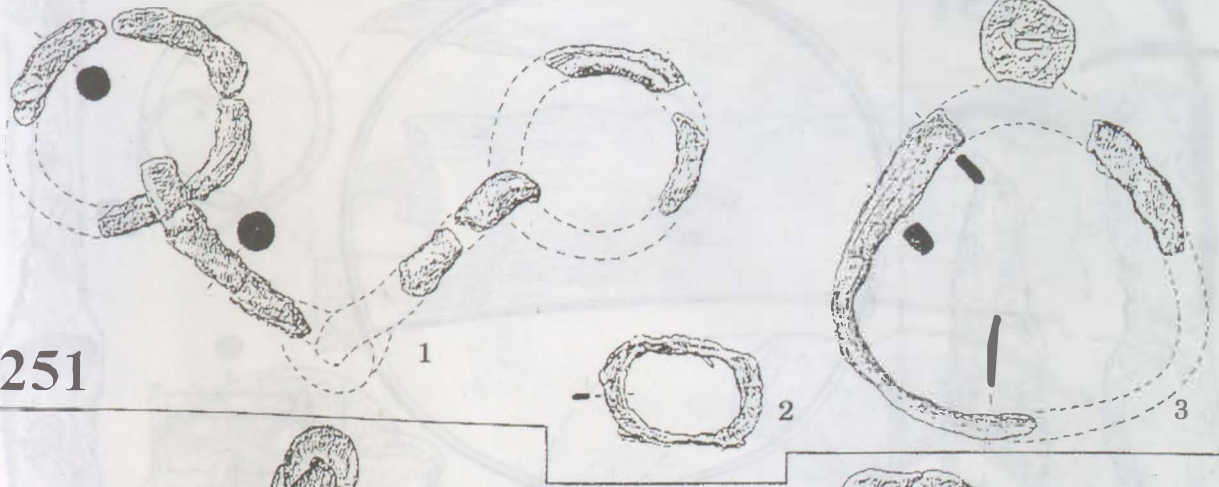

252



257

327. tábla: Sárrétudvari-Hízóföld. 251–252., 257. sír (1–8. 1:3; 9. 1:2)

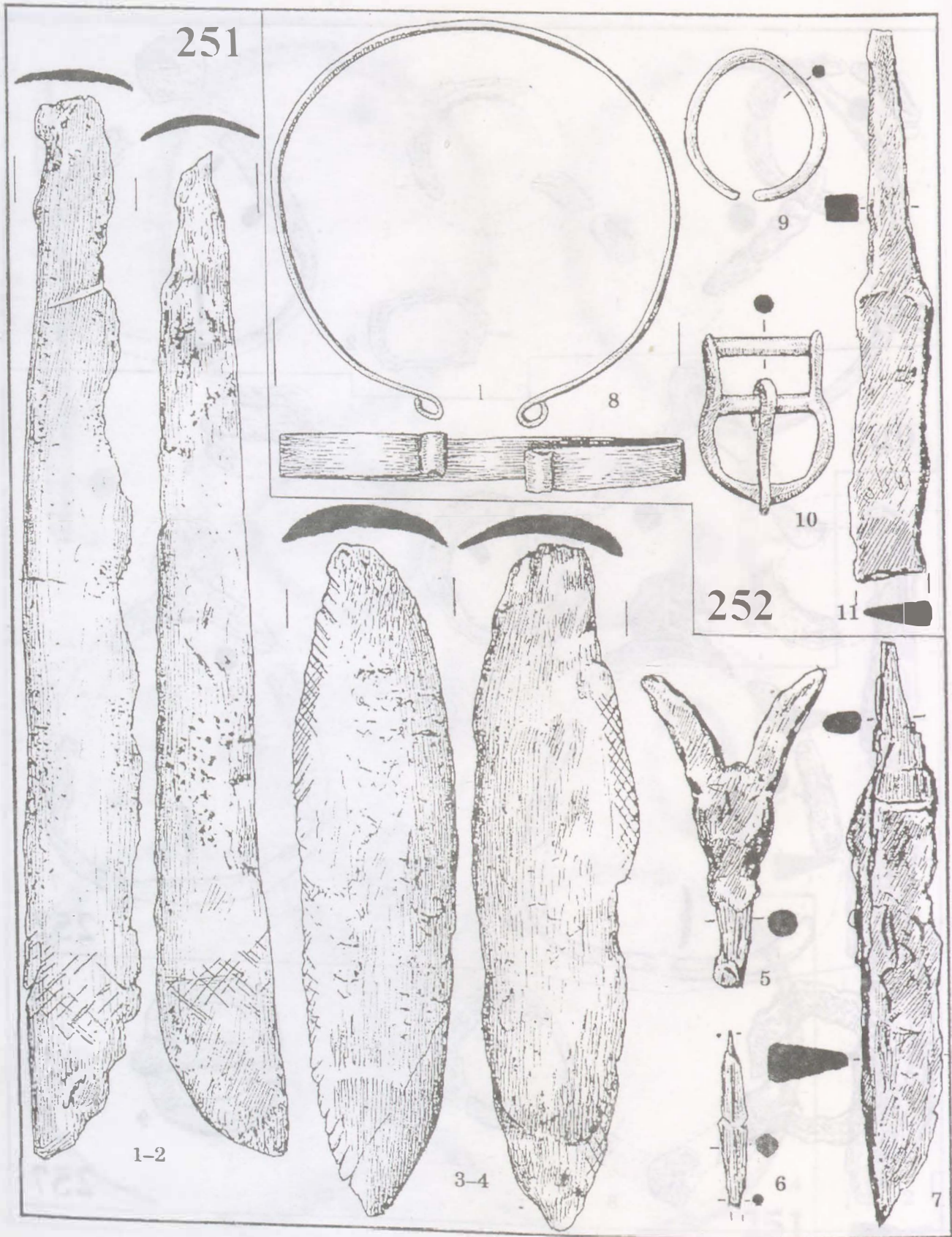

328. tábla: Sárrétudvari-Hízófold. 251–252. sír (1:1)

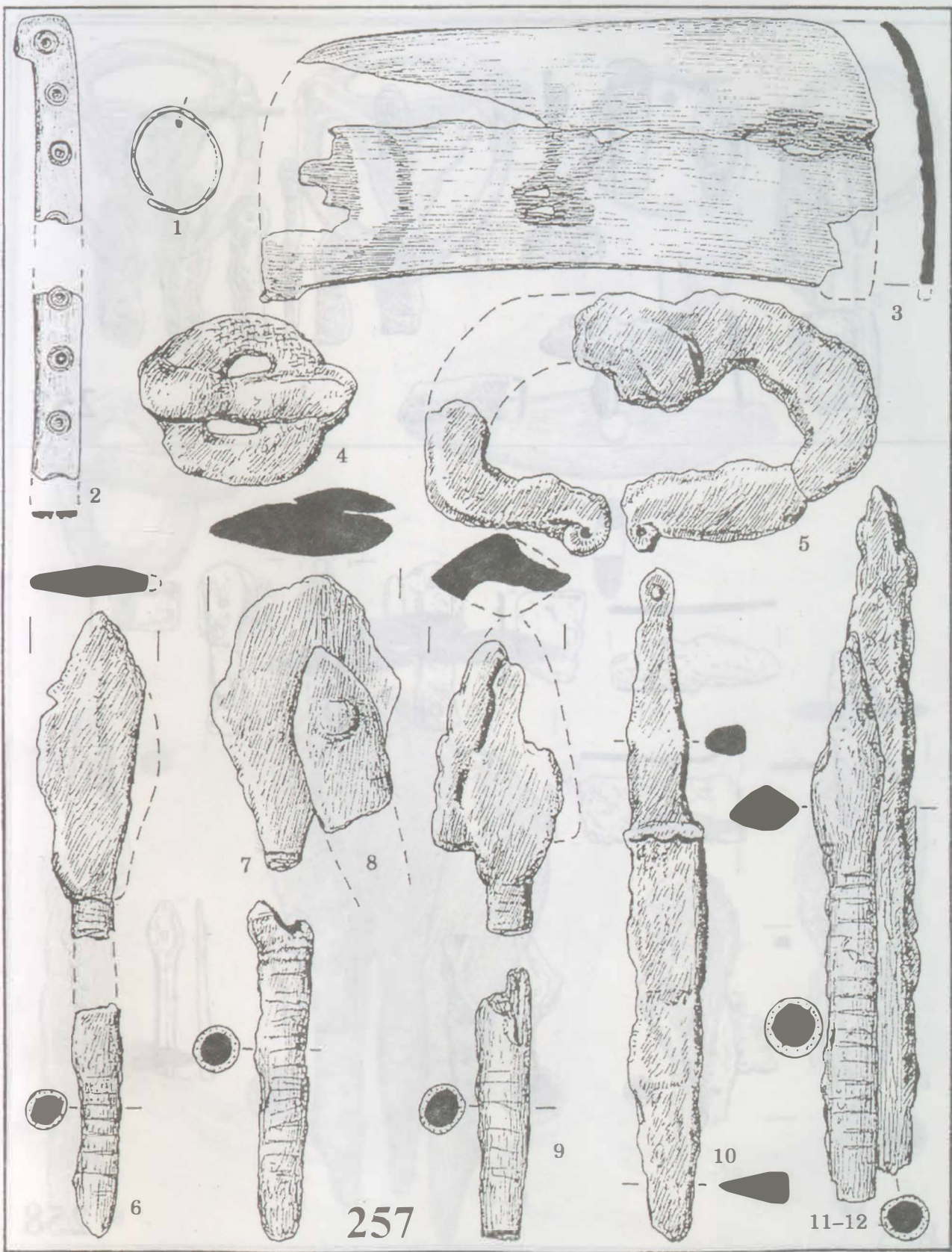

257

329. tábla: Sárrétudvari-Hízófold. 257. sír (1:1)

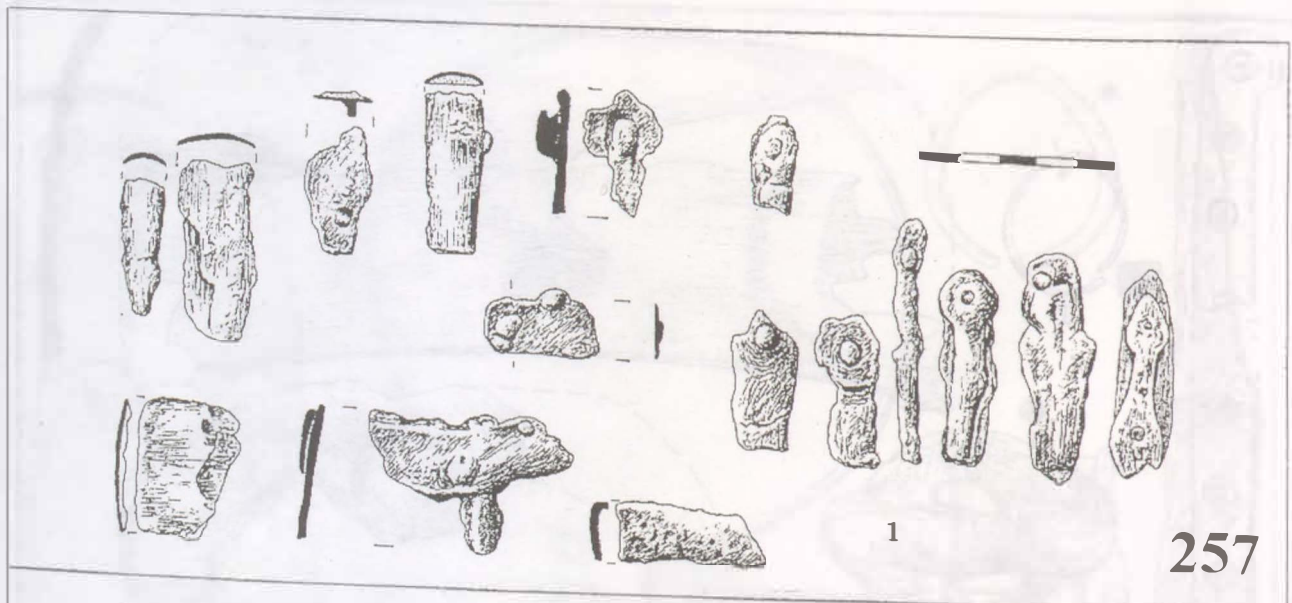

257

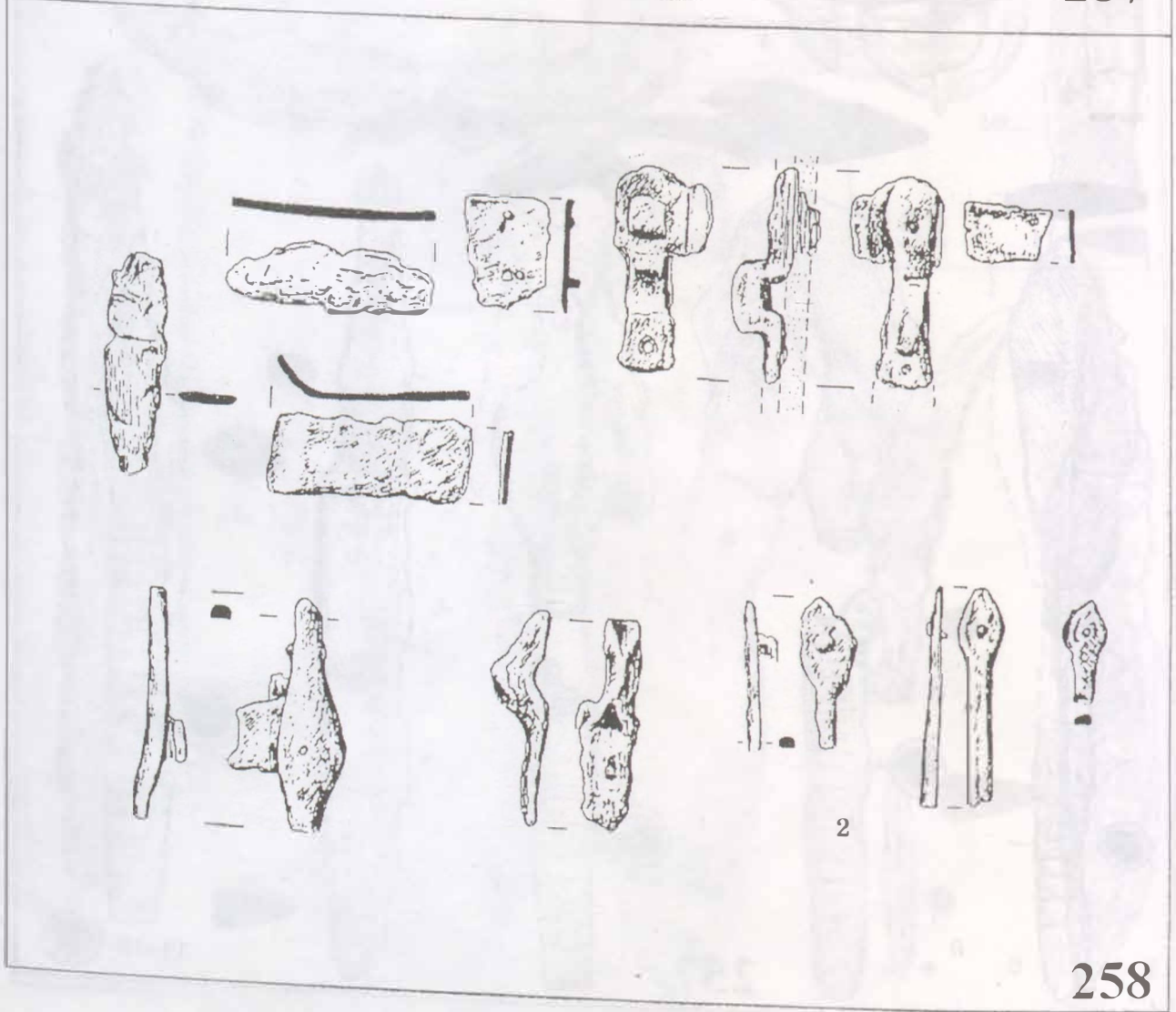

258

330. tábla: Sárrétudvari-Hízófold. 257-258. sír (1:2)

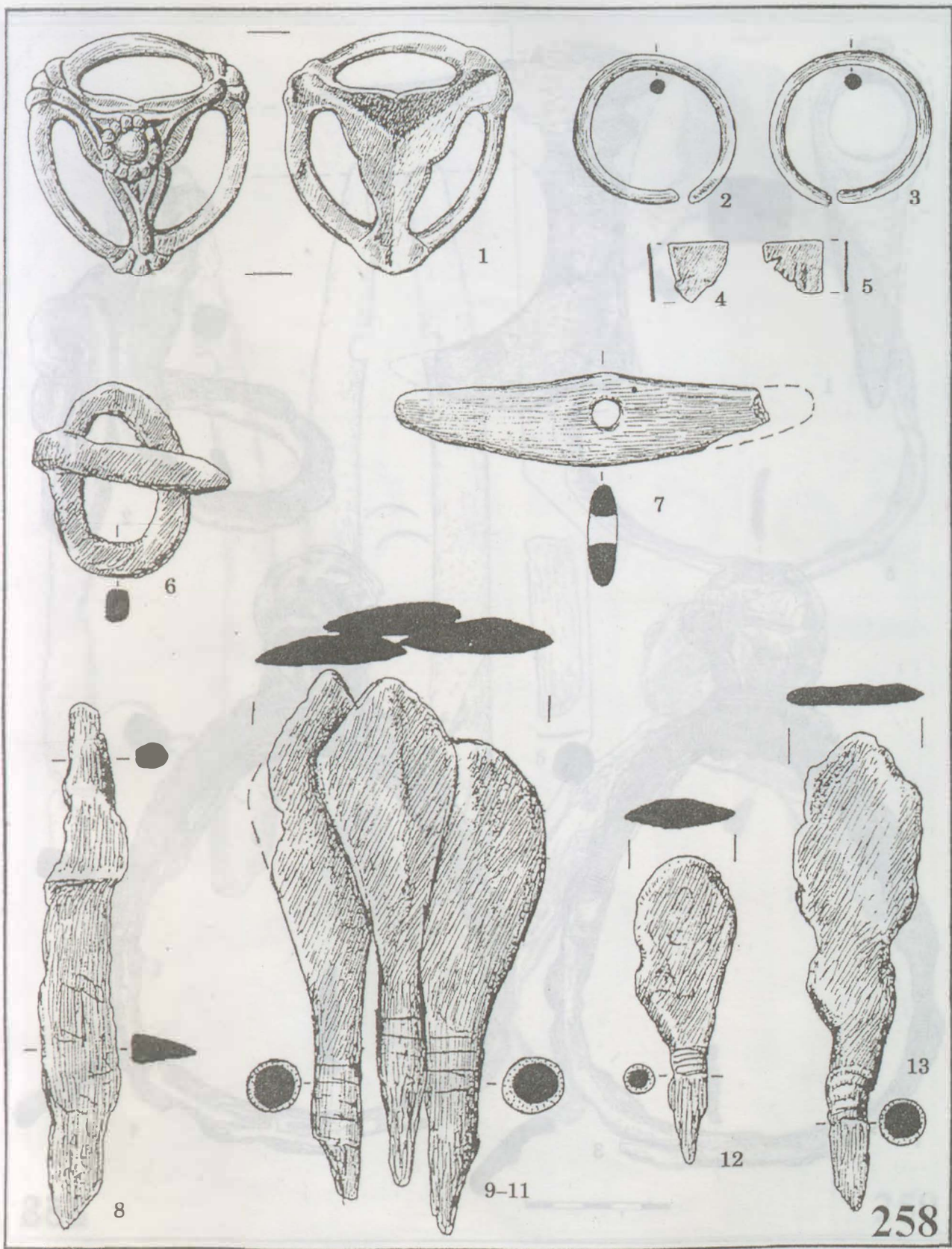

331. tábla: Sárrétudvari-Hízóföld. 258. sír (1:1)

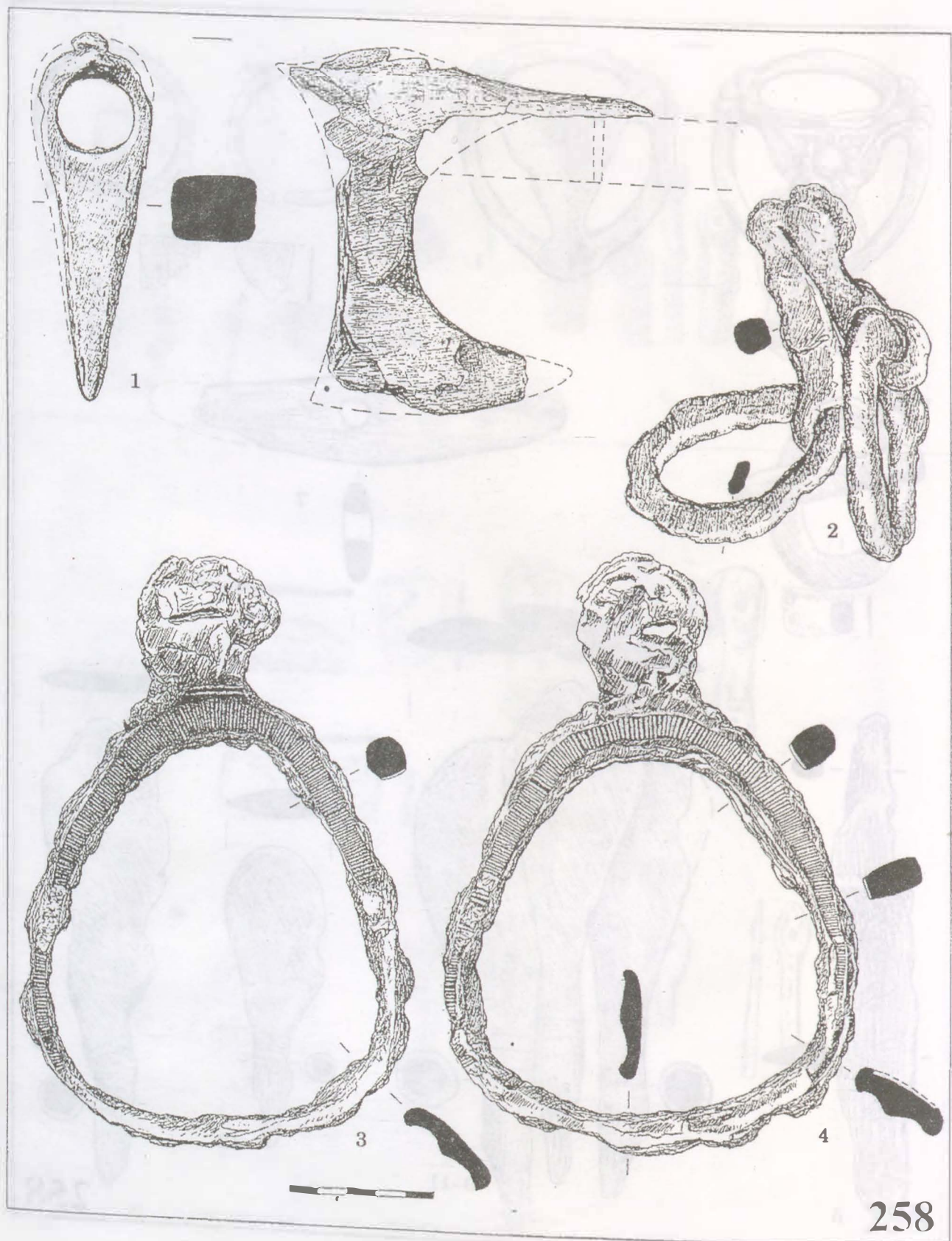

332. tábla: Sárrétudvari-Hízófold. 258. sír (1:2)

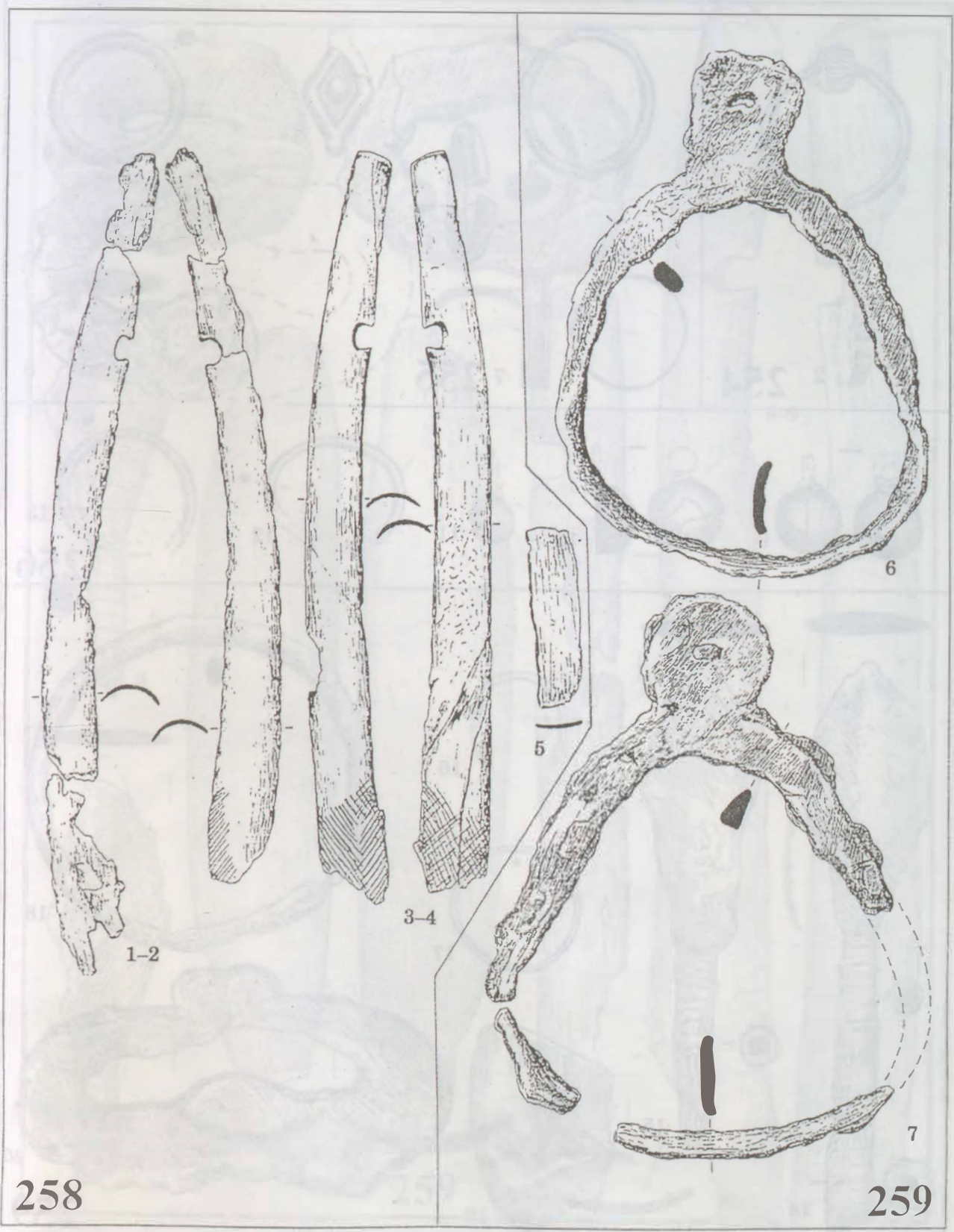

258

259

333. tábla: Sárrétudvari-Hízóföld. 258–259. sír (1:2)

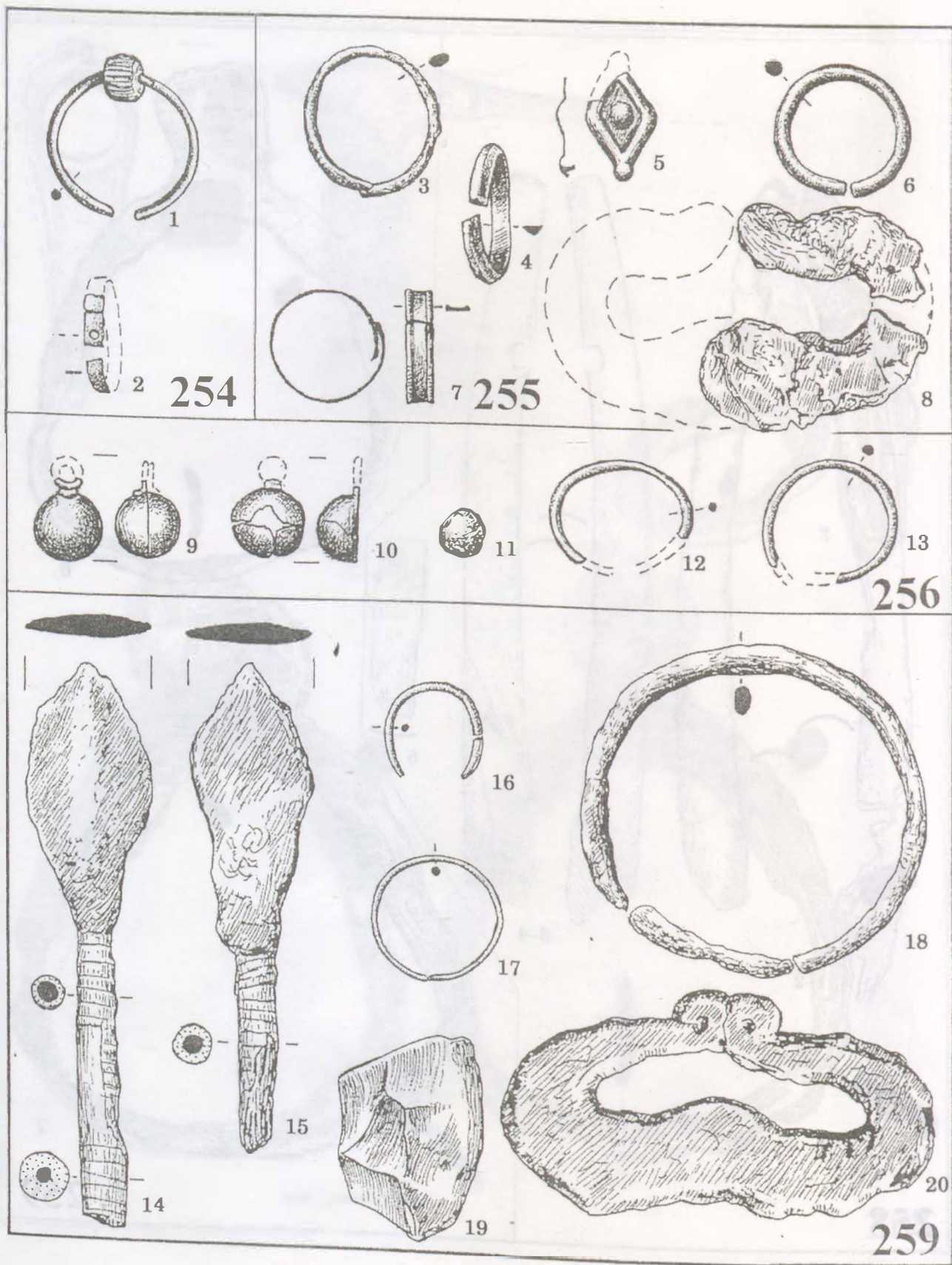

334. tábla: Sárretudvari-Hízófold. 254-256., 259. sír (1:1)

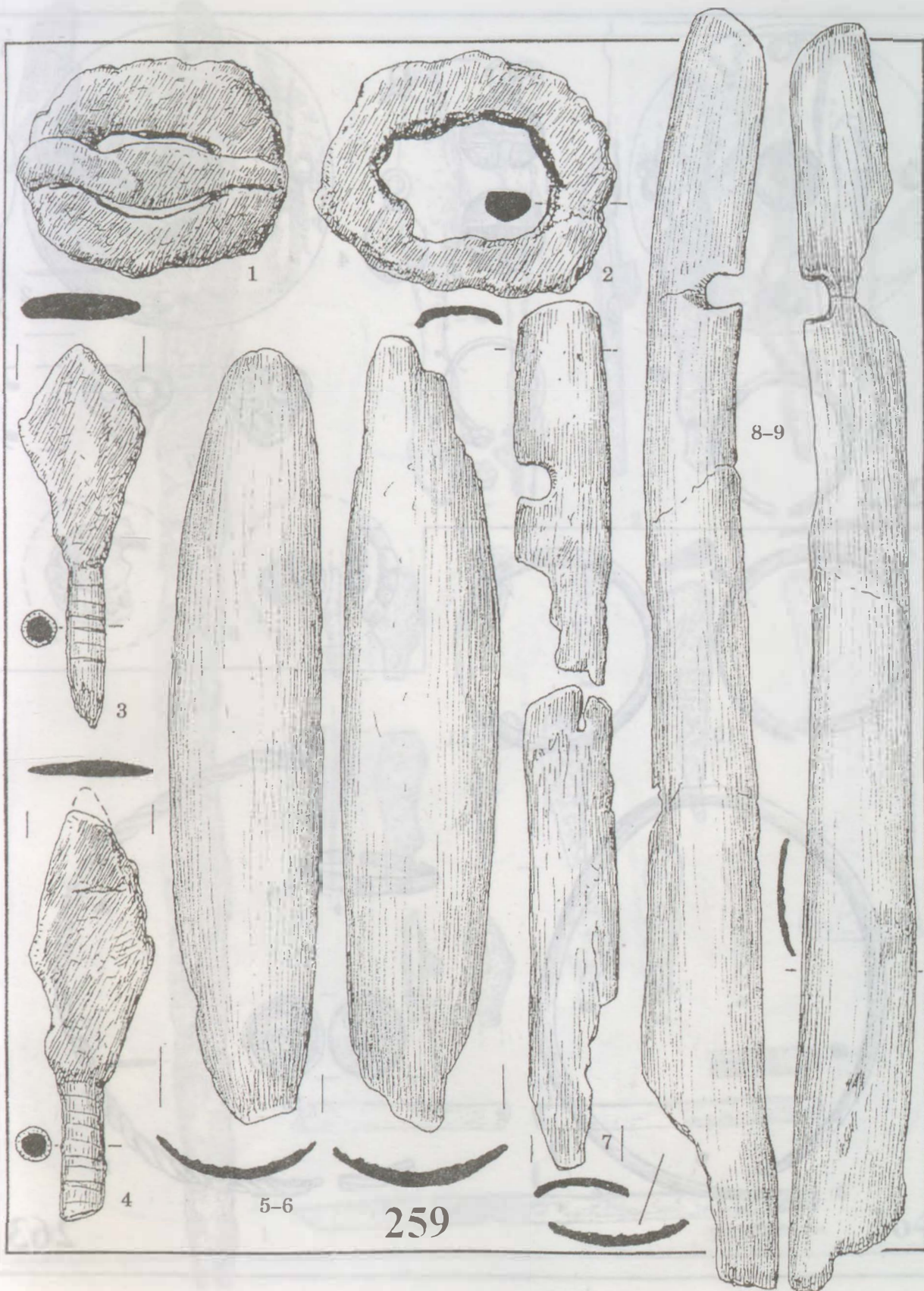

335. tábla: Sárrétudvari-Hízófold. 259. sár (1:1)

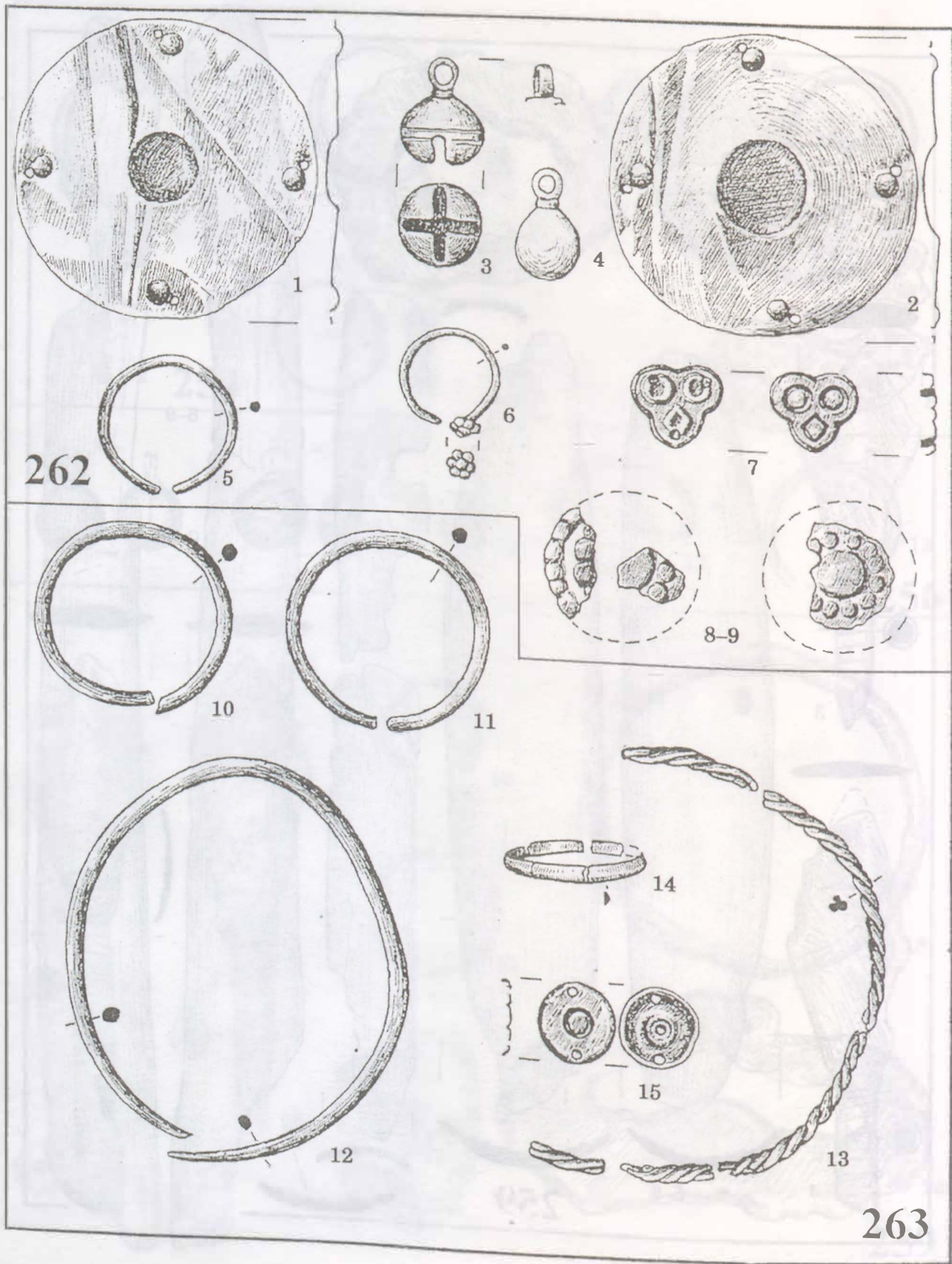

262

263

336. tábla: Sárrétudvari-Hízófold. 262-263. sír (1:1)



337. tábla: Sárretudvari-Hízófold. 264. sír (1. 1:4; 2. 75%; 3-5. 1:2)

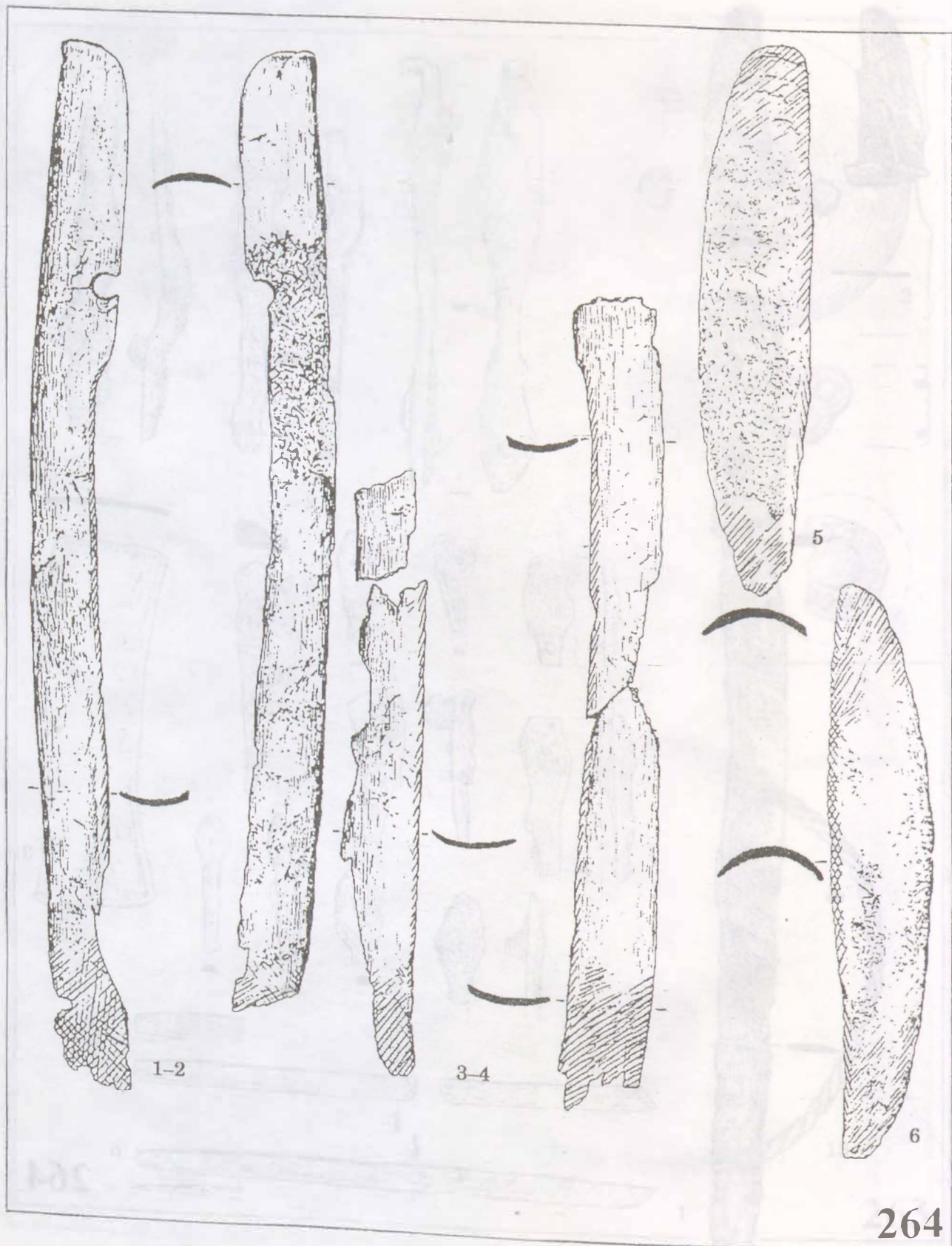

338. tábla: Sárrétudvari-Hízóföld. 264. sír (75%)

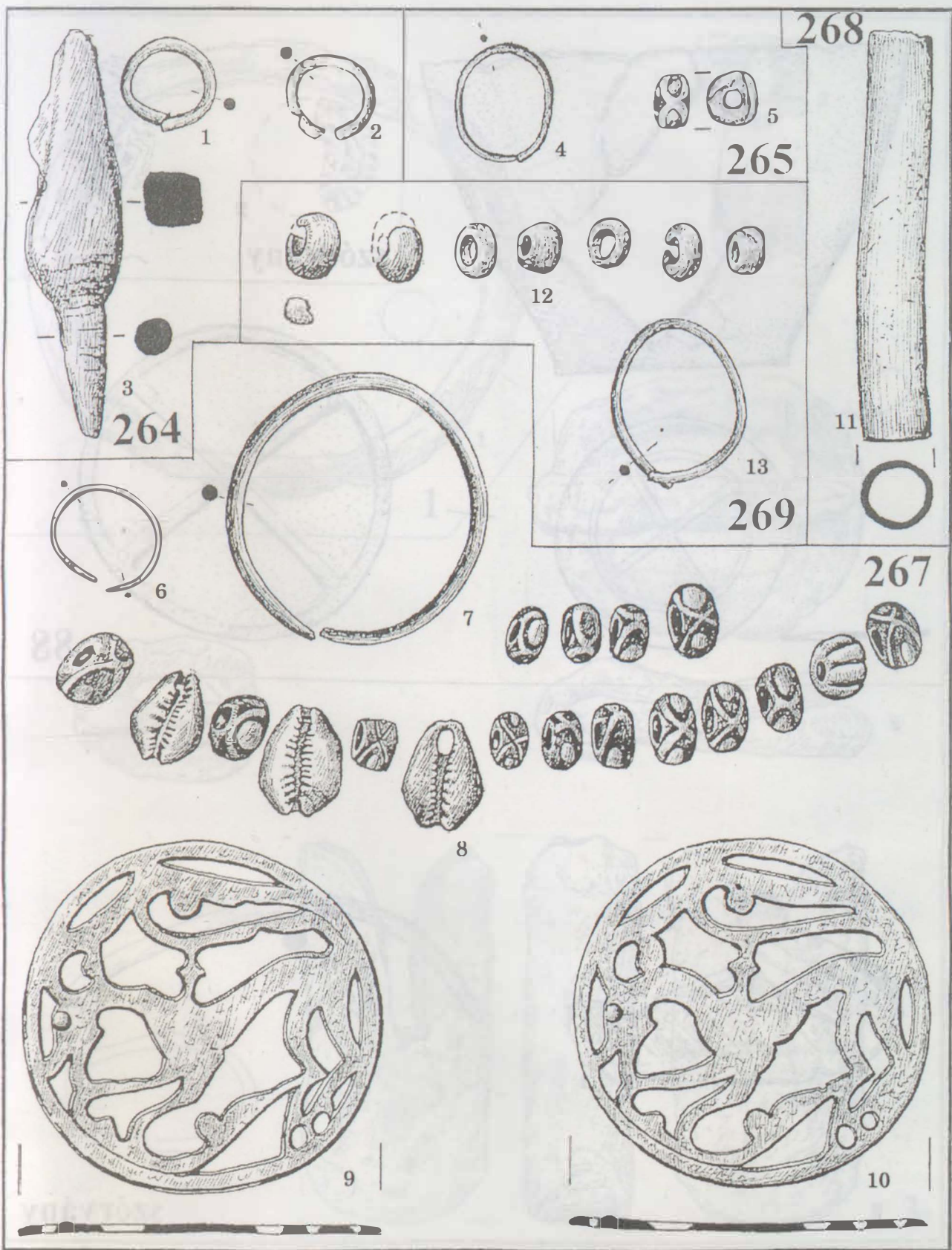

339. tábla: Sárretudvari-Hízófold. 264–265., 267–269. sír (1:1)

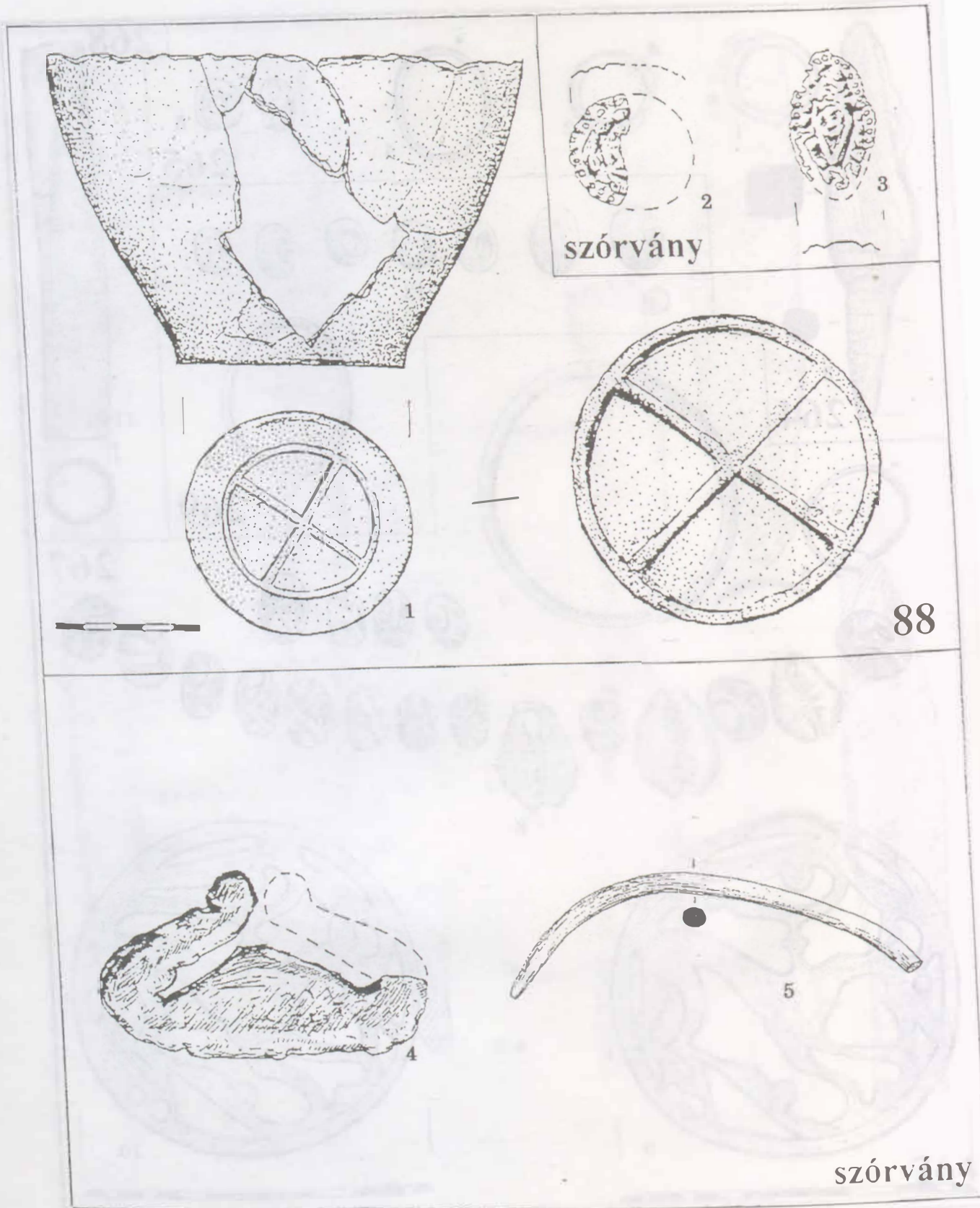

340. tábla: Sárrétudvari-Hízófold. 88. sír (1:2), szórvány (1:1)

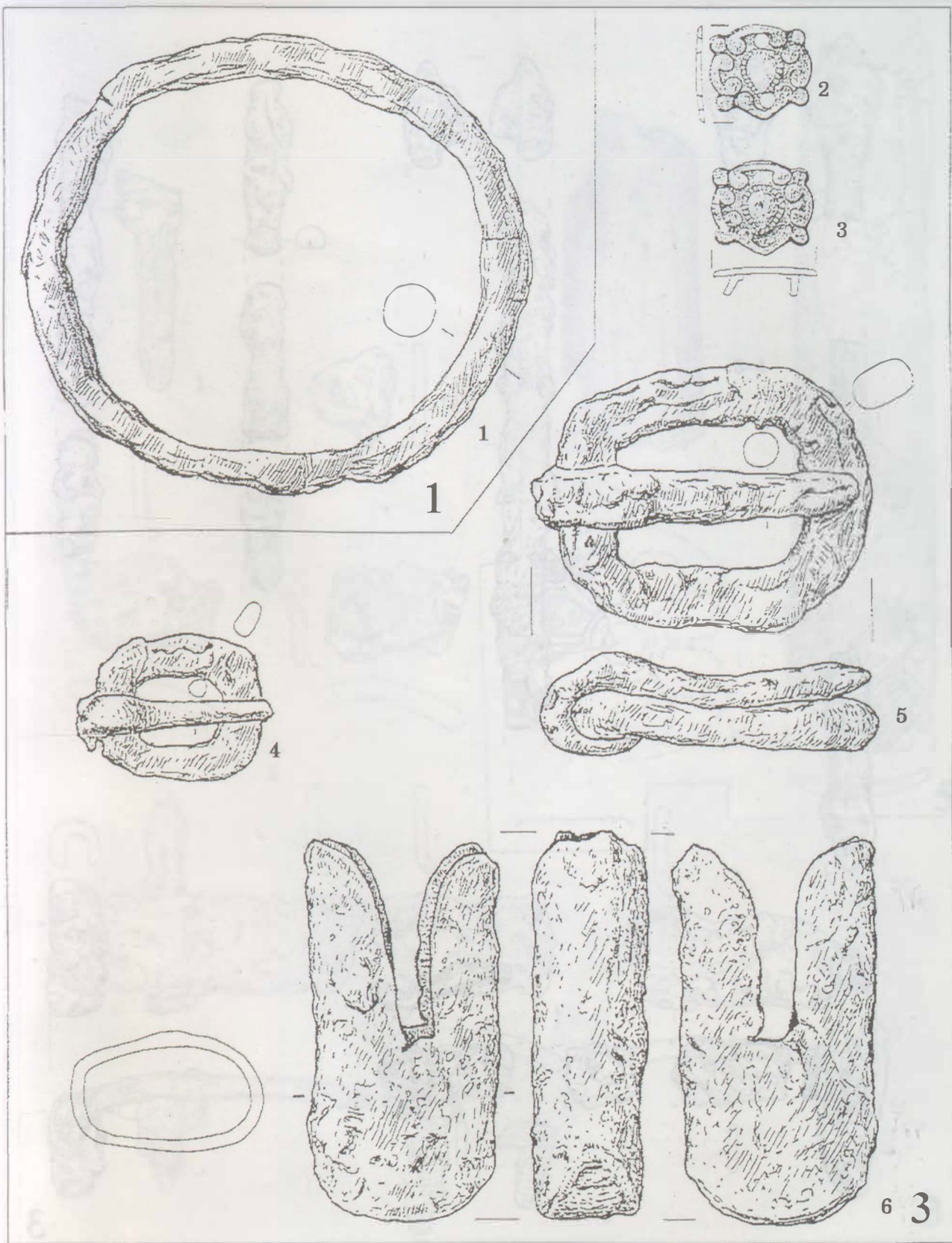

341. tábla: Sárrétudvari-Órhalom. 1., 3. sír (1:1)

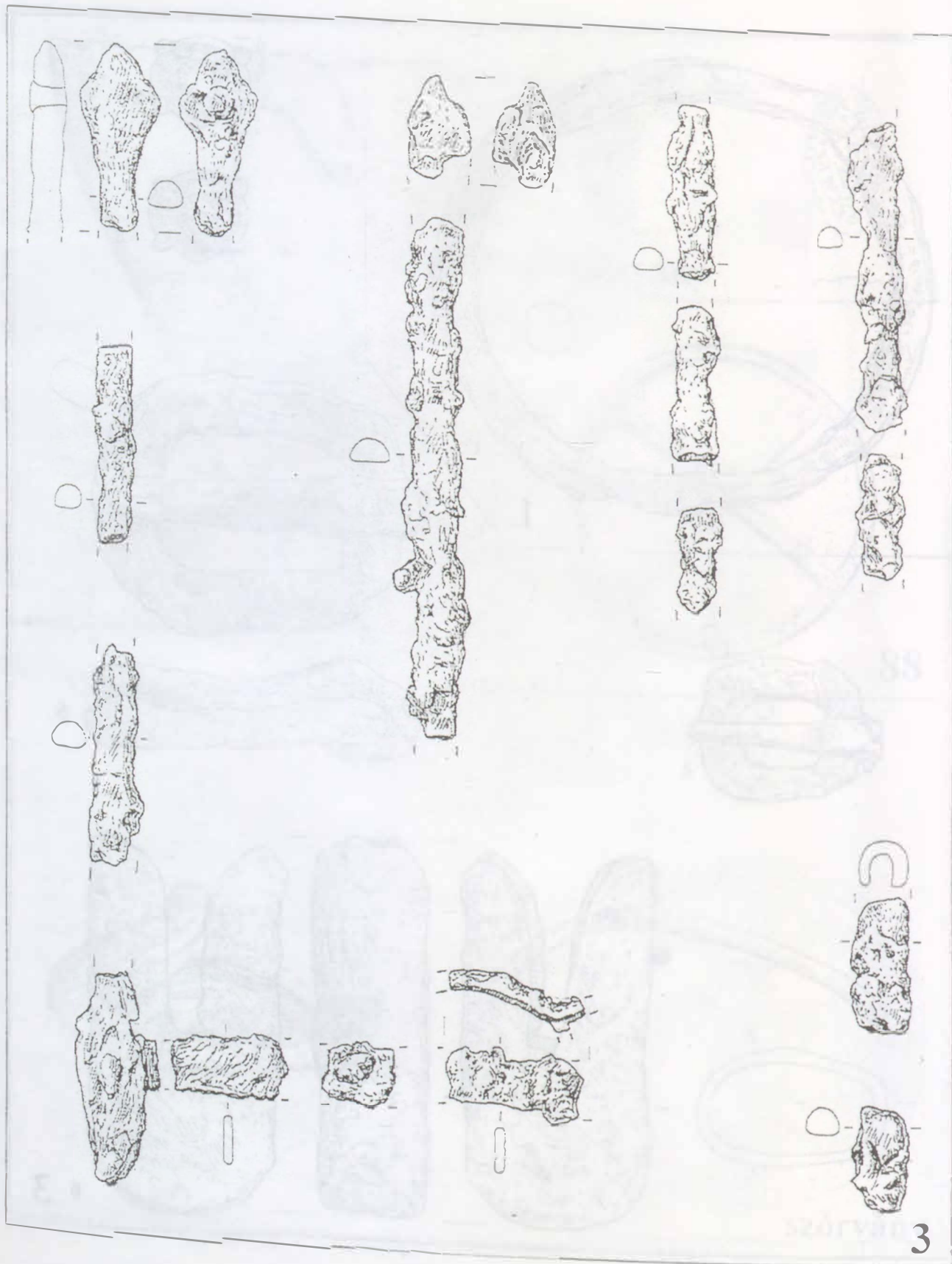

342. tábla: Sárrétudvari-Órhalom. 3. sír (1:1)

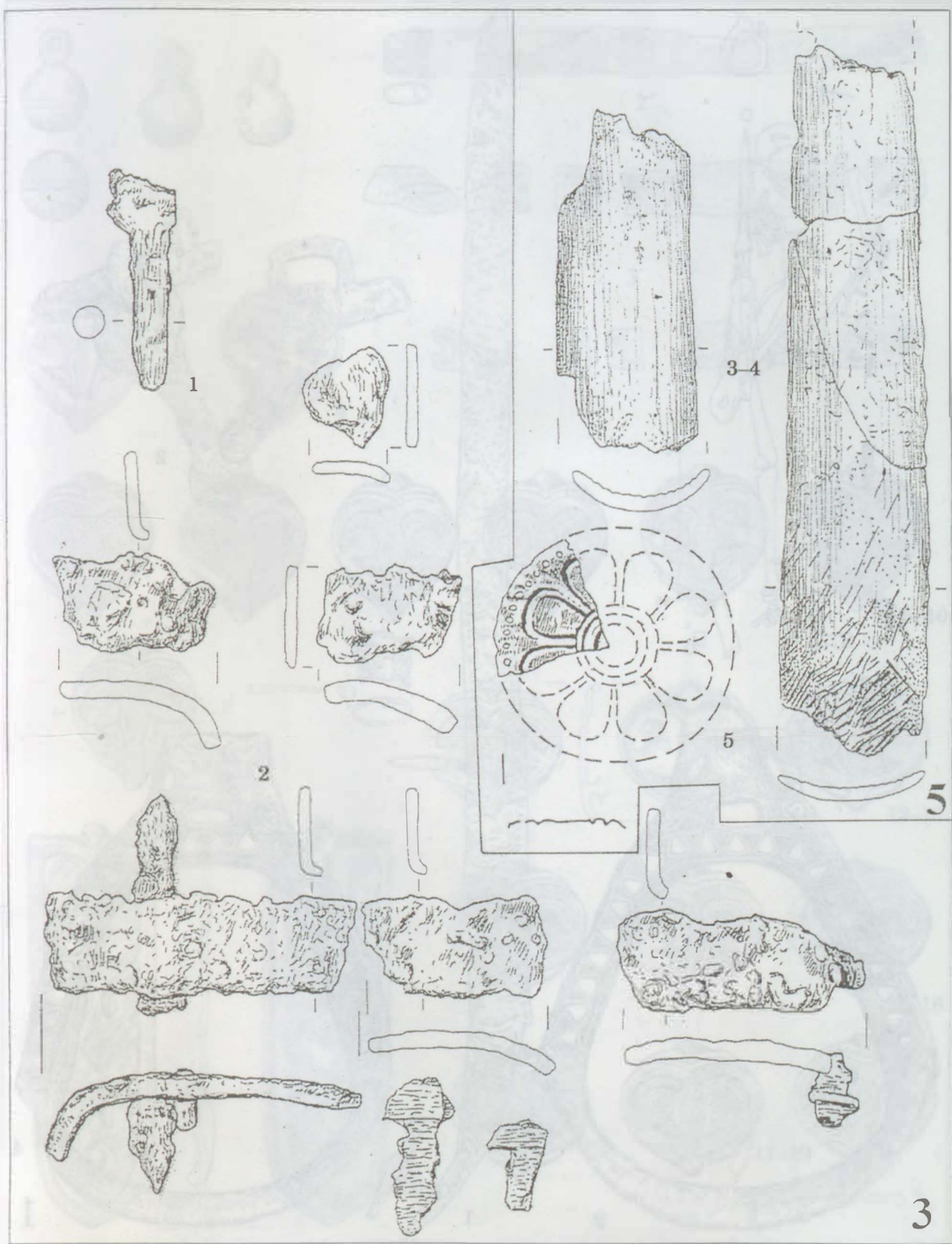

343. tábla: Sárretudvari-Órhalom. 3., 5. sír (1:1)

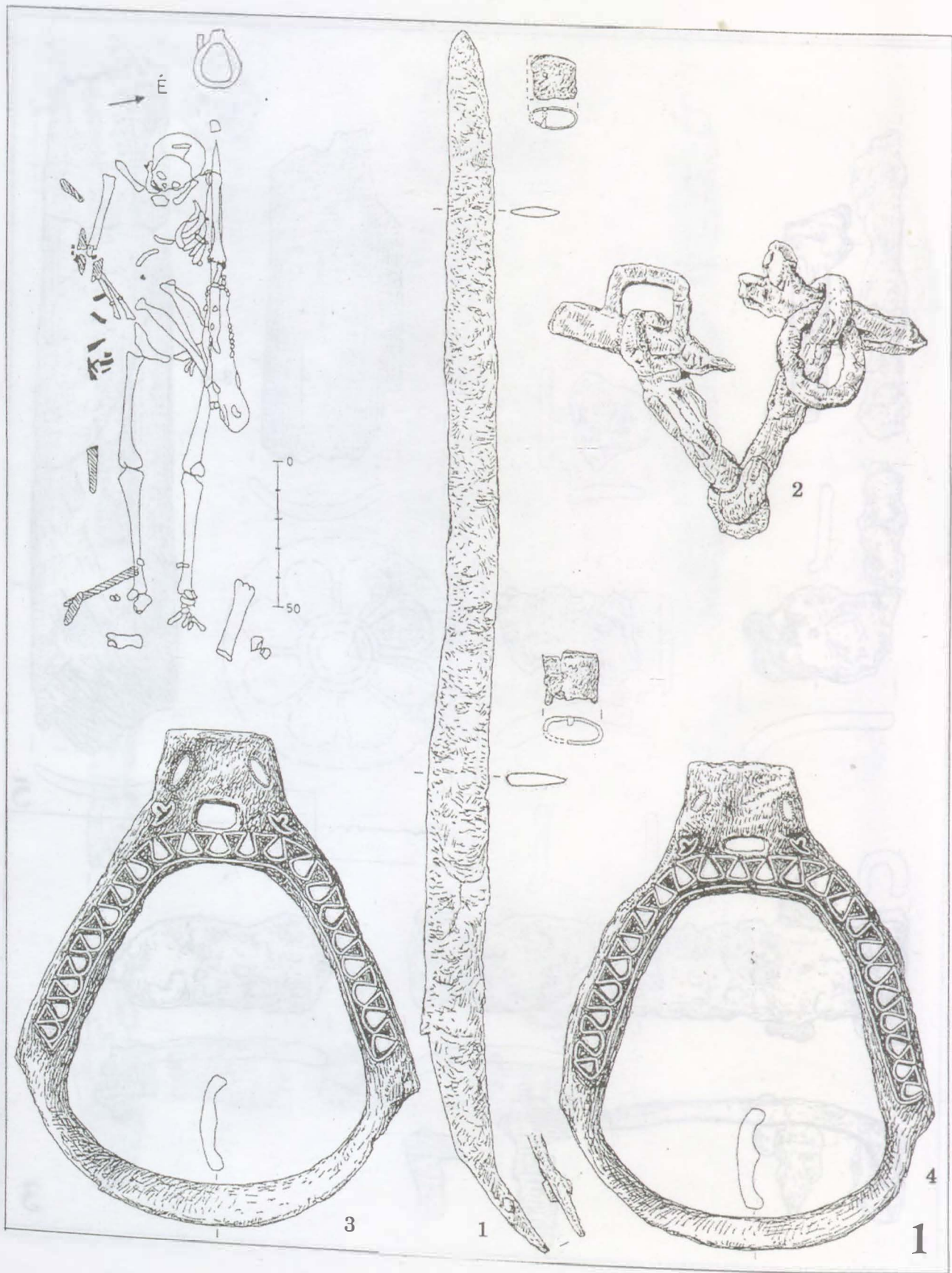

344. tábla: Sárrétudvari-Poroshalom. 1. sír (1, 3. 1:2; 2. 1:4)



345. tábla: Sárretudvari-Poroshalom. 1. sár (1:1)

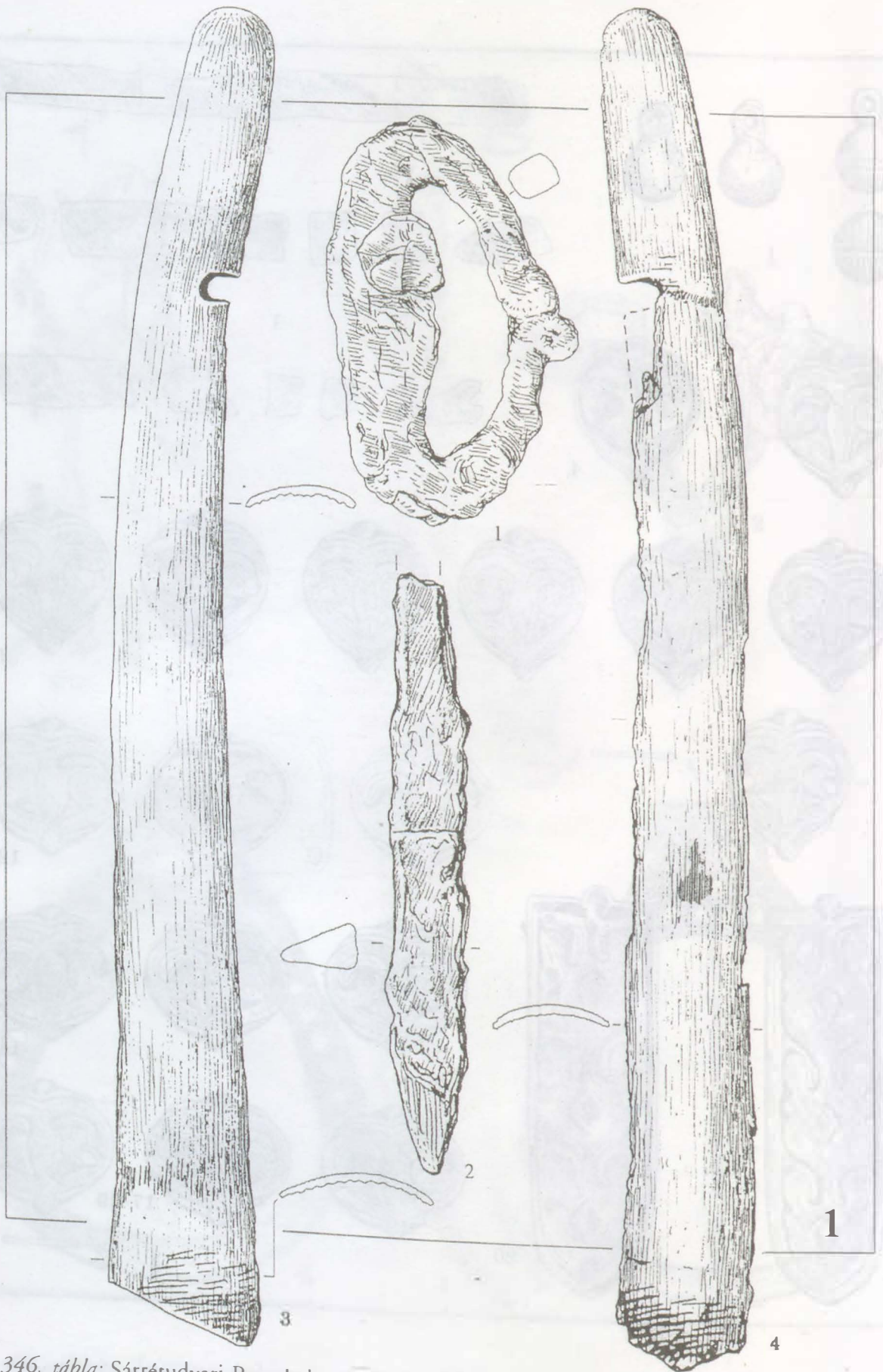

346. tábla: Sárrétudvari-Poroshalom. 1. sír (1:1)

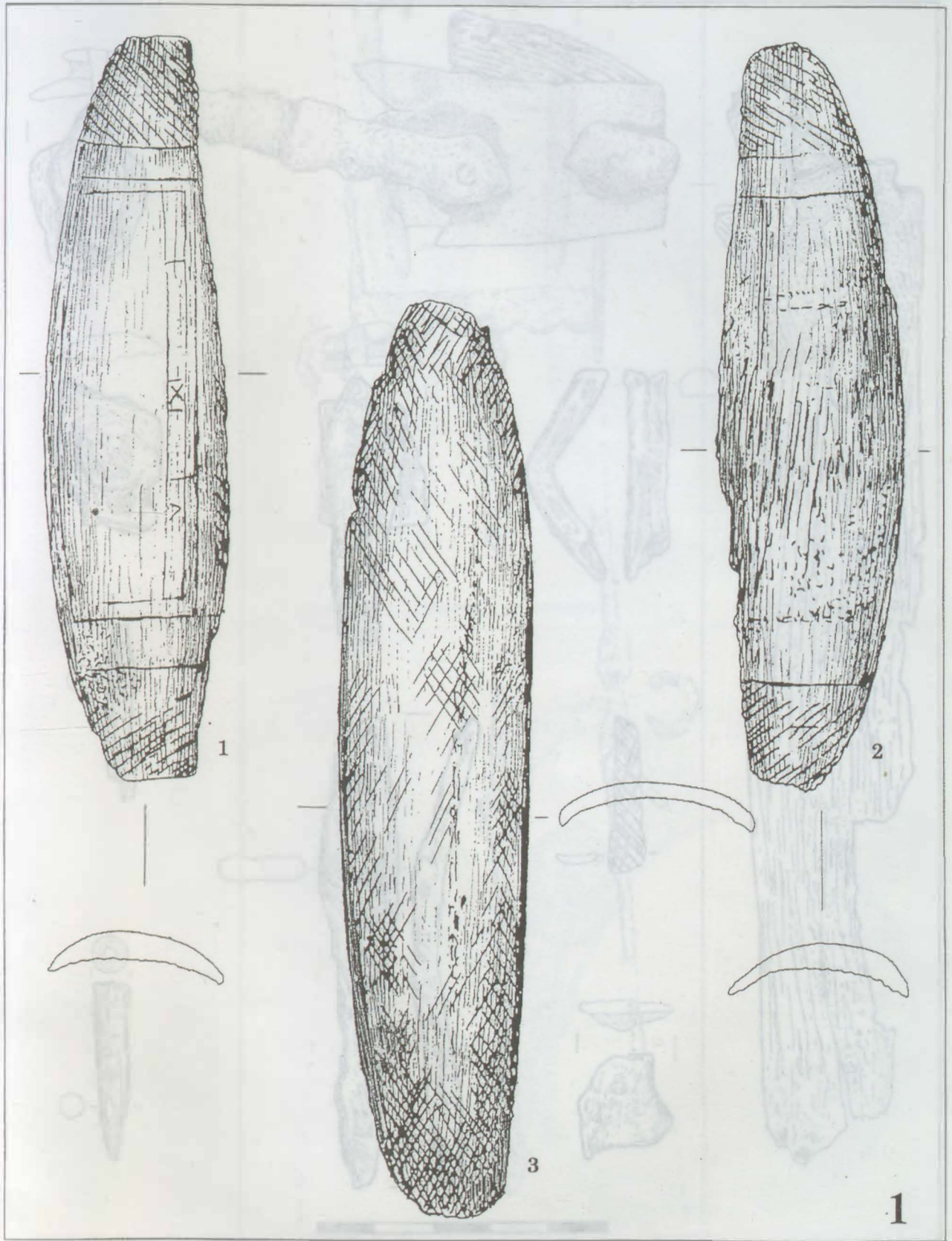

347. tábla: Sárrétudvari-Poroshalom. 1. sír (1:1)

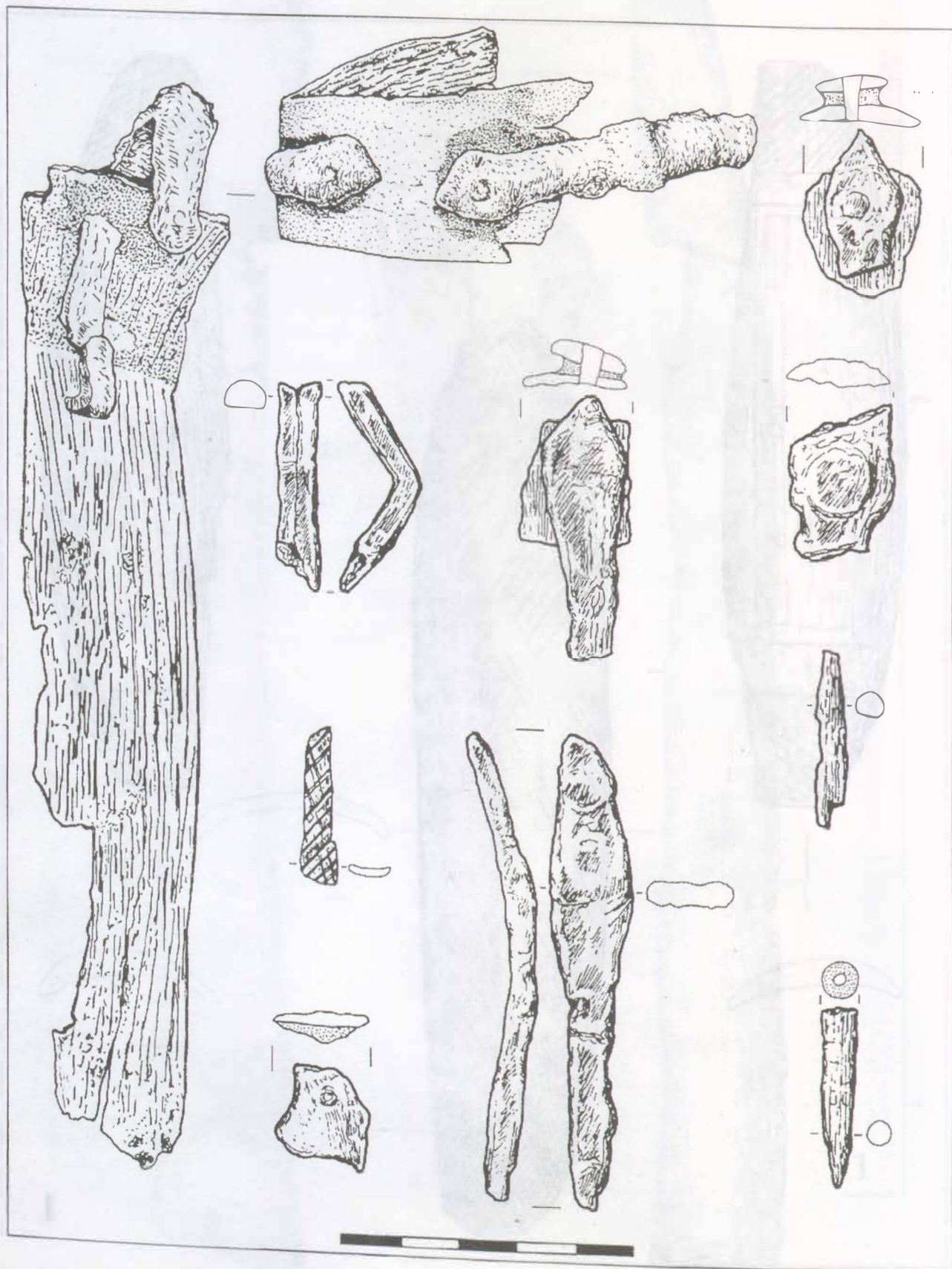

348. tábla: Sárrétudvari-Poroshalom. 1. sír (1:1)

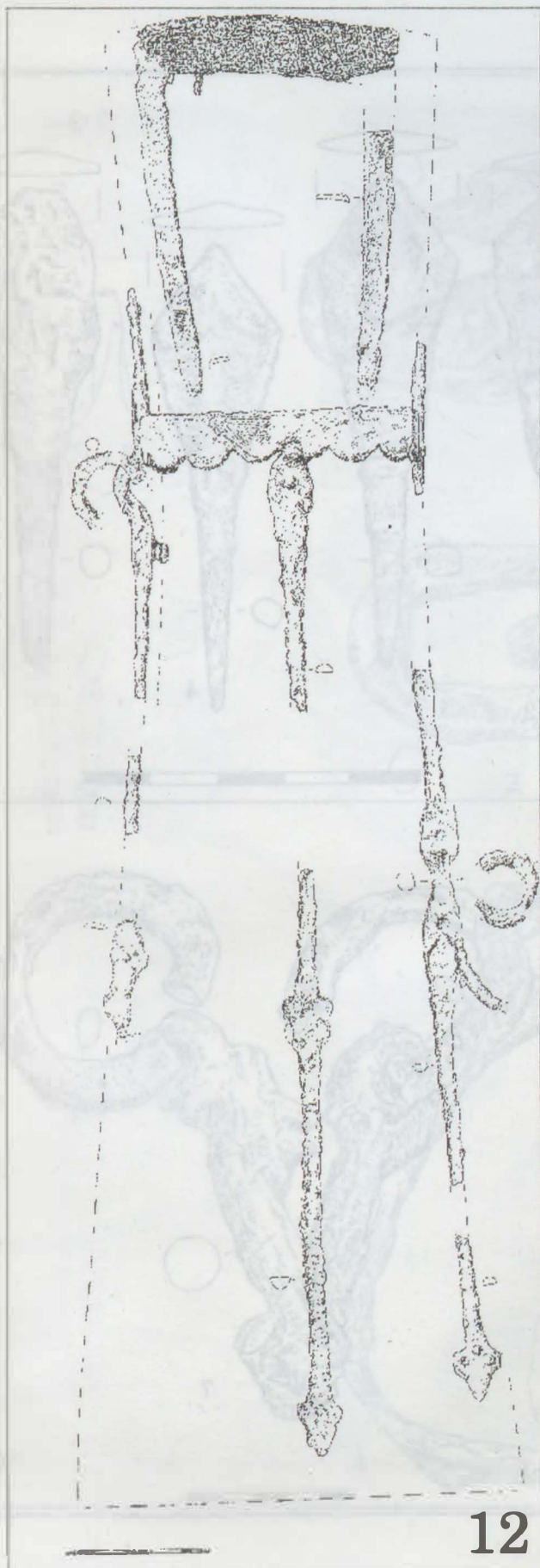

349. tábla: Sárretudvari-Poroshalom. 12. sár

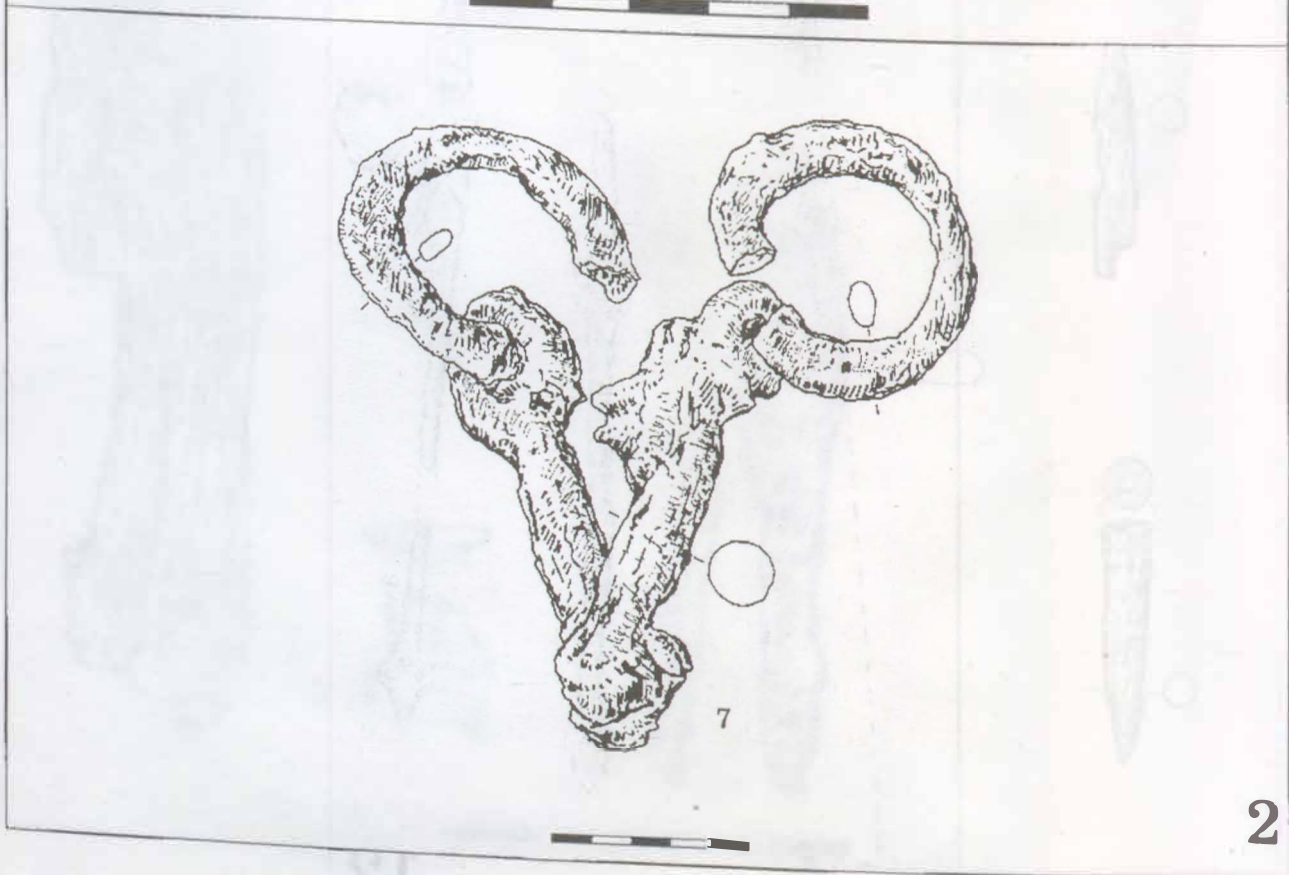
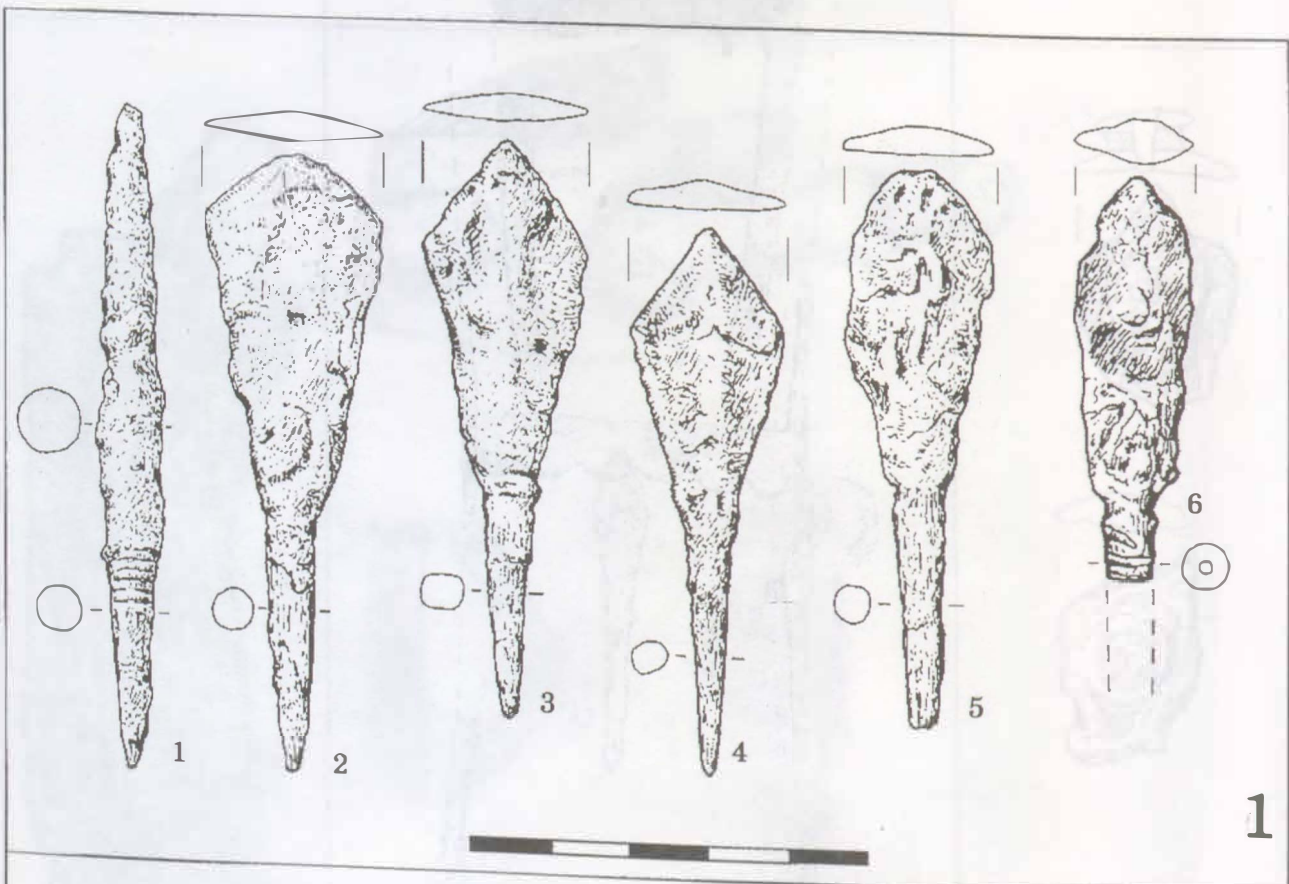

350. tábla: Sárrétudvari-Poroshalom. 1., 2. sír (1. 1:1; 2. 1:2)

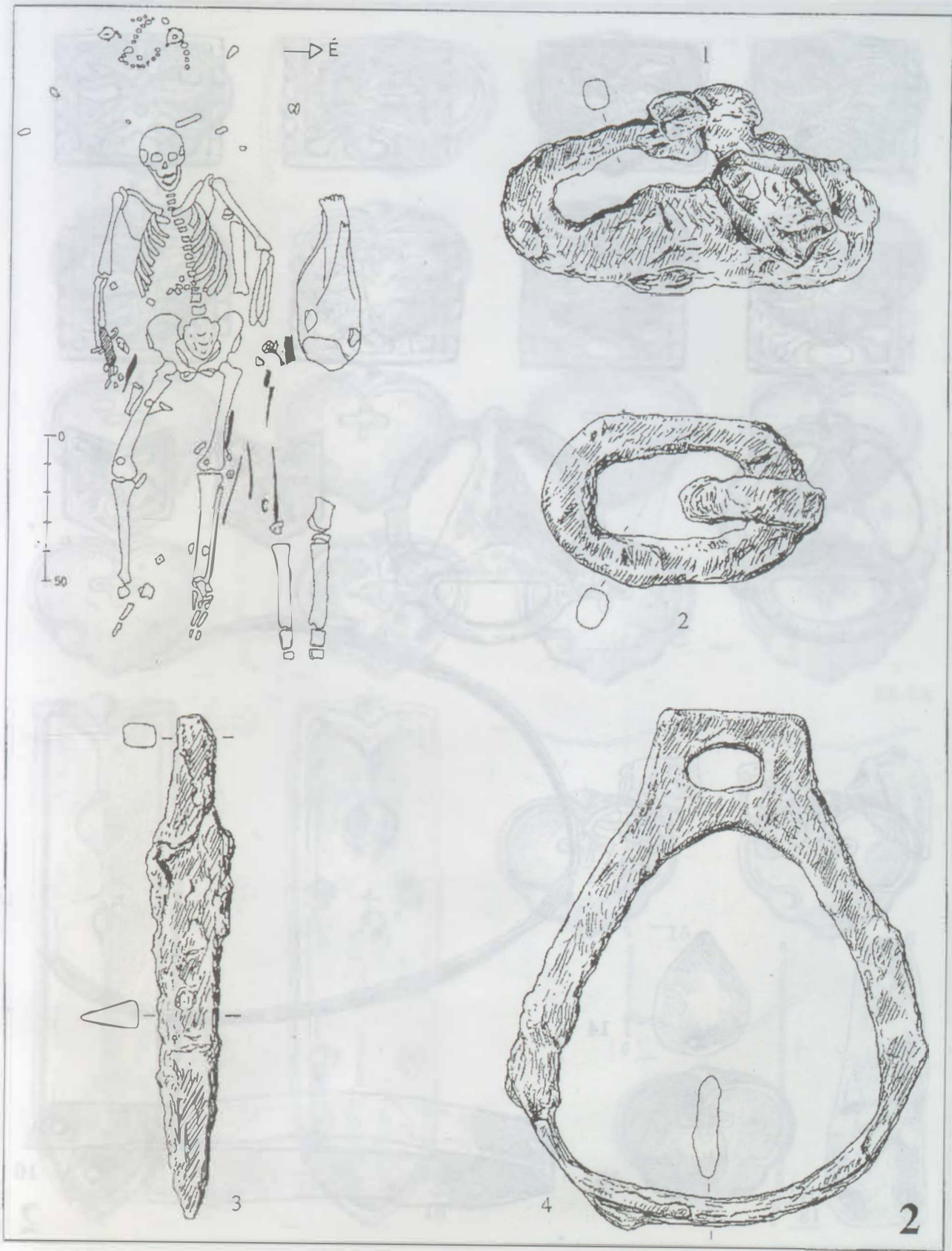

351. tábla: Sárrétudvari-Poroshalom. 2. sír (1-3. 1:1; 4. 1:2)

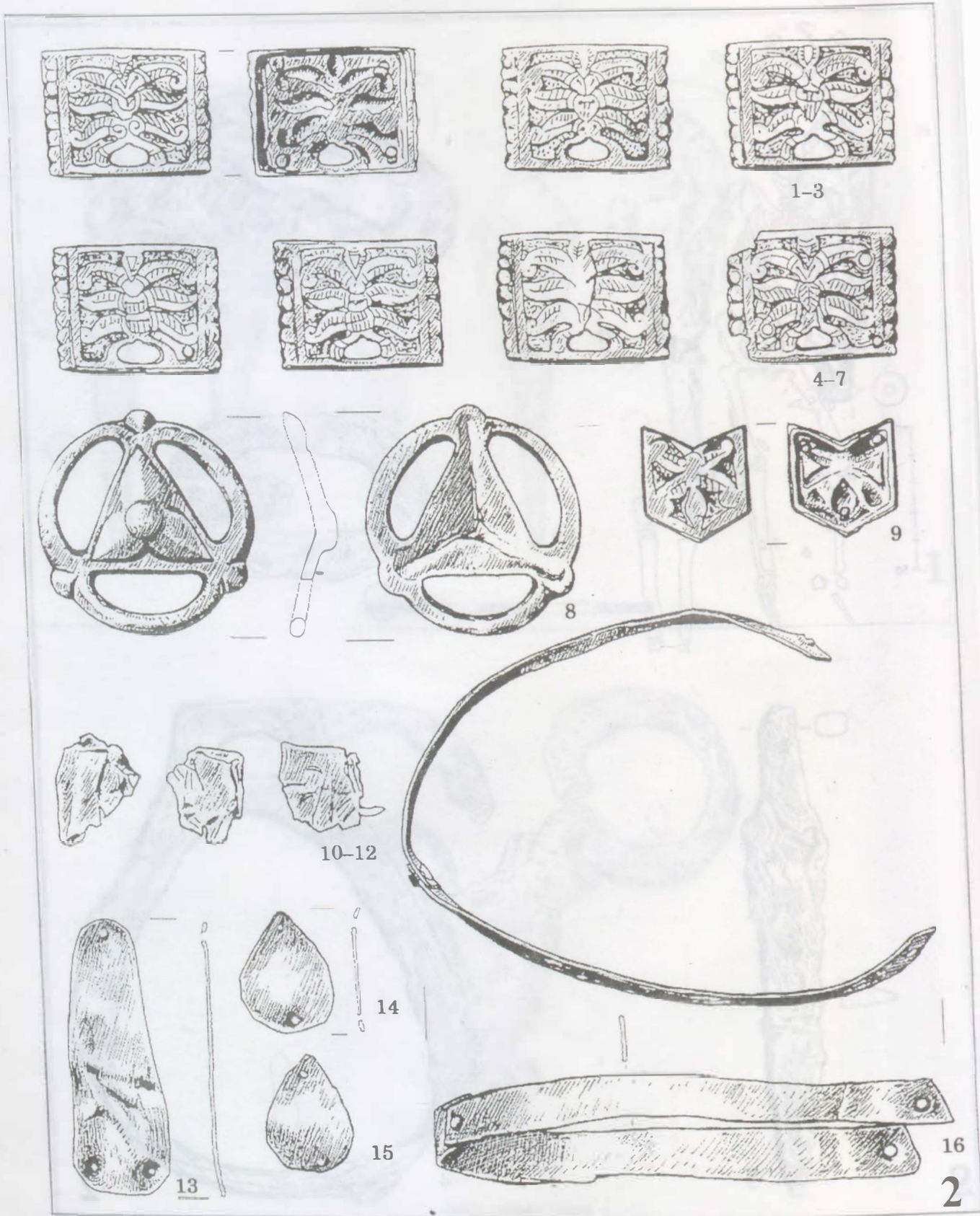

352. tábla: Sárrétudvari-Poroshalom. 2. sír (1:1)

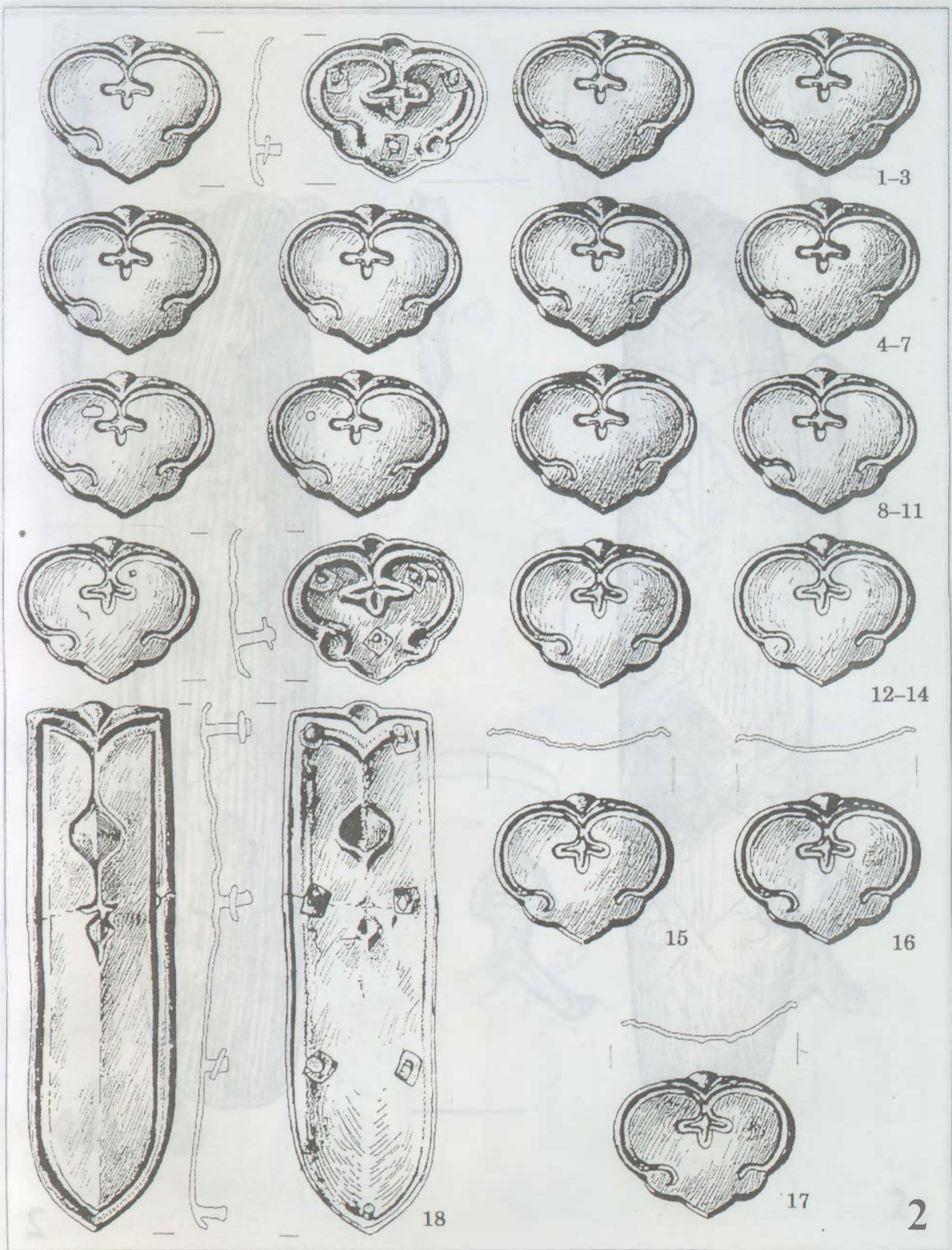

353. tábla: Sárretudvari-Poroshalom. 2. sír (1:1)

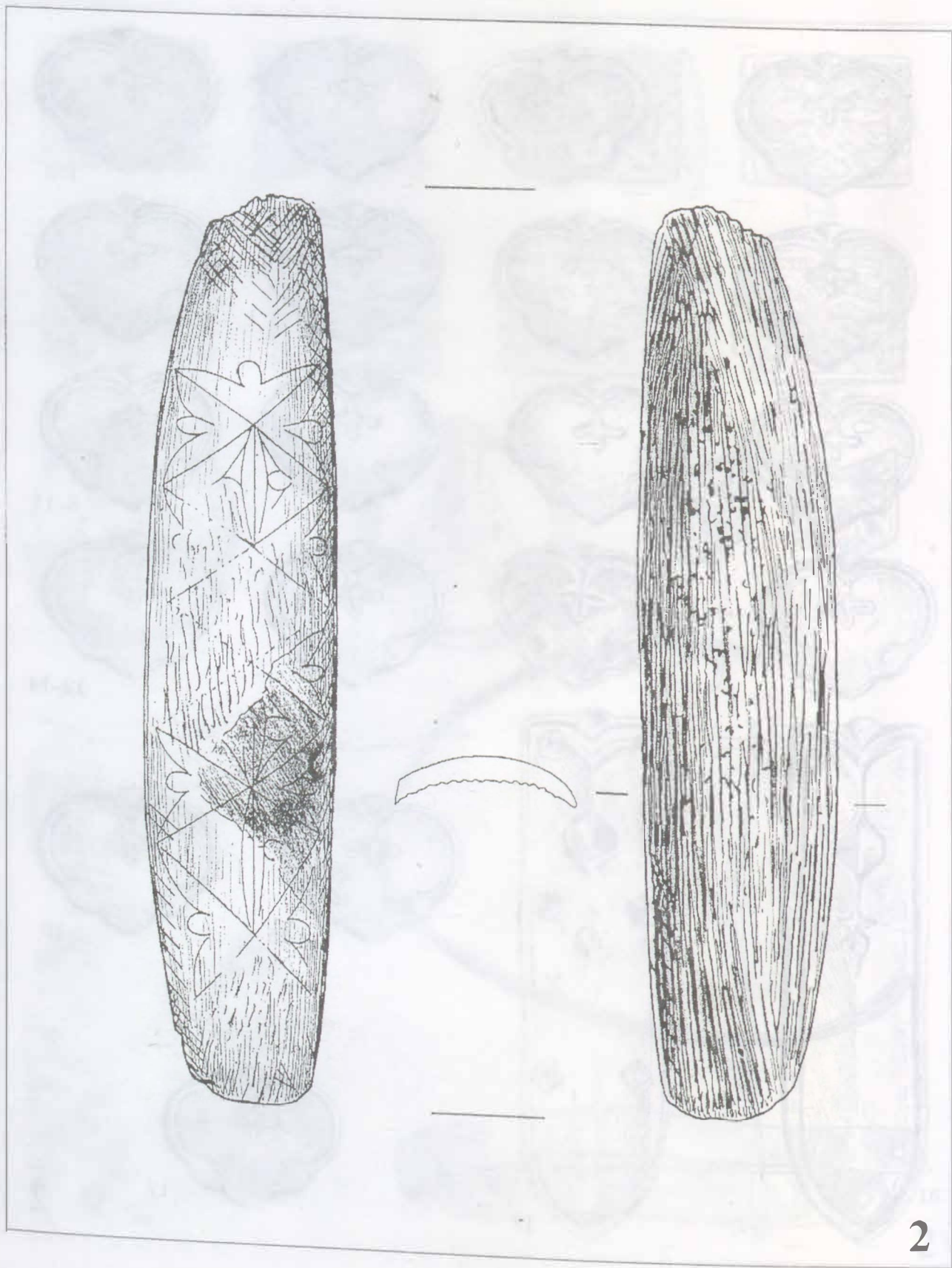

2

354. tábla: Sárrétudvari-Poroshalom. 2. sír (1:1)

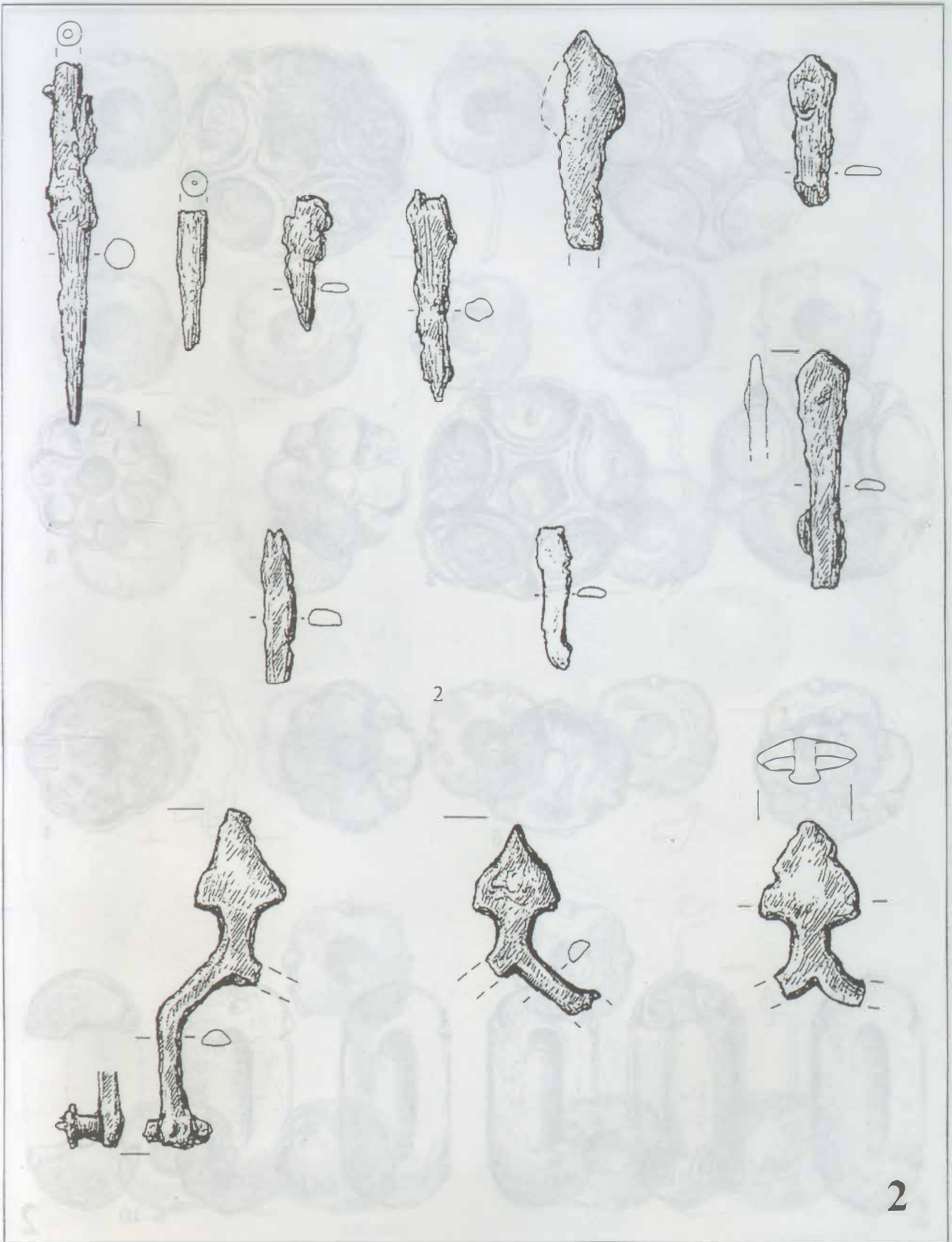

355. tábla: Sárrétudvari-Poroshalom. 2. sír (1:1)

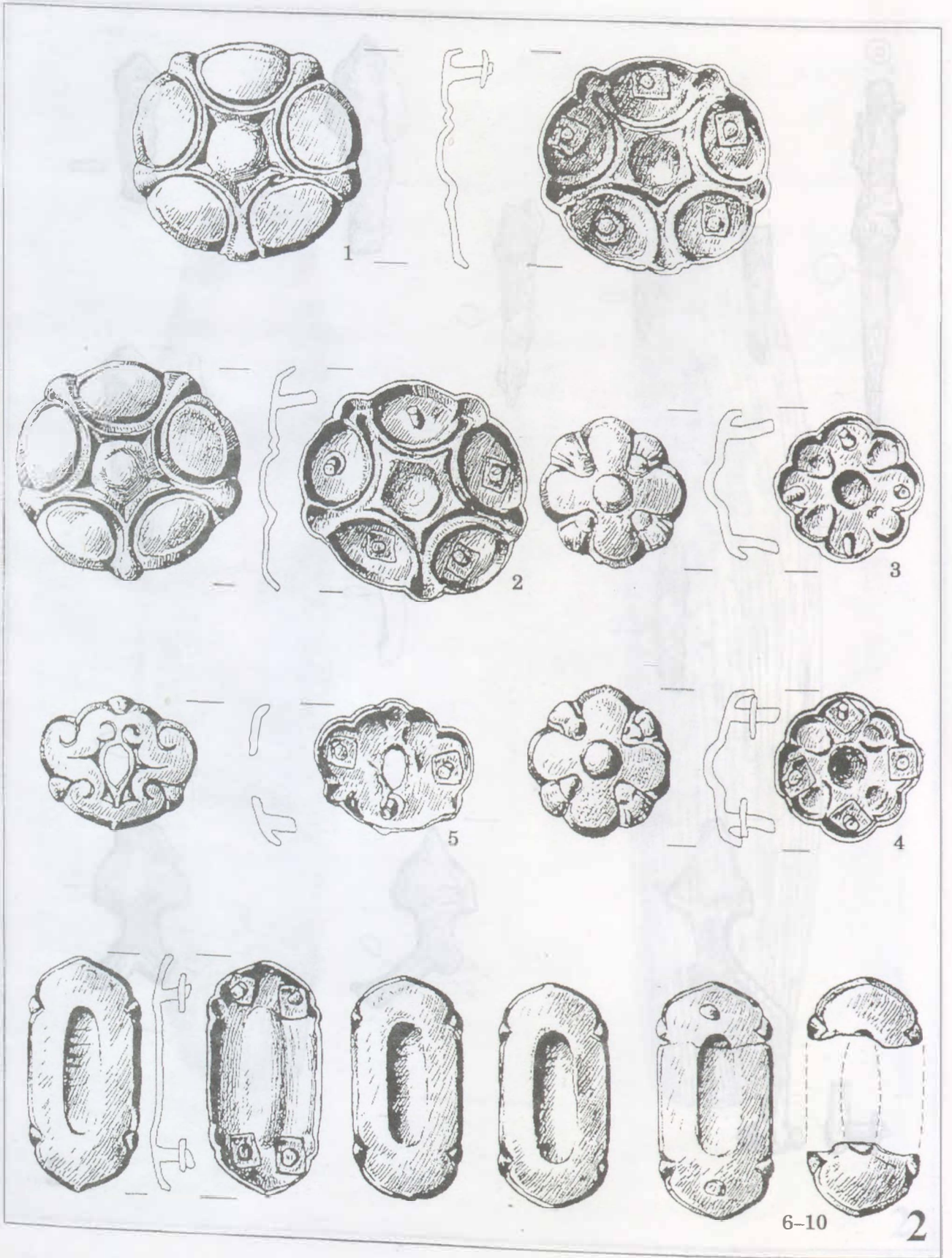

356. tábla: Sárrétudvari-Poroshalom. 2. sír (1:1)

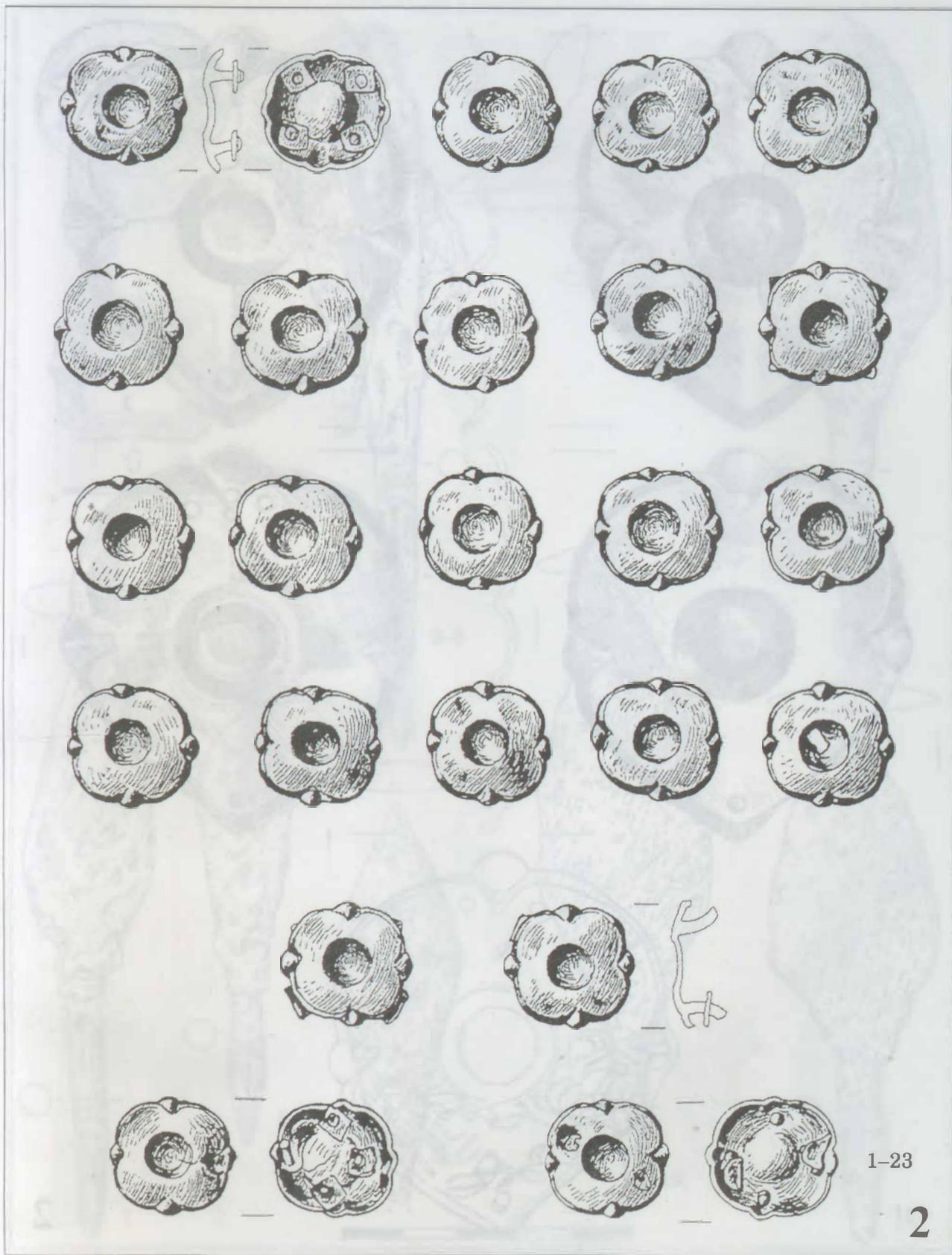

357. tábla: Sárrétudvari-Poroshalom. 2. sír (1:1)

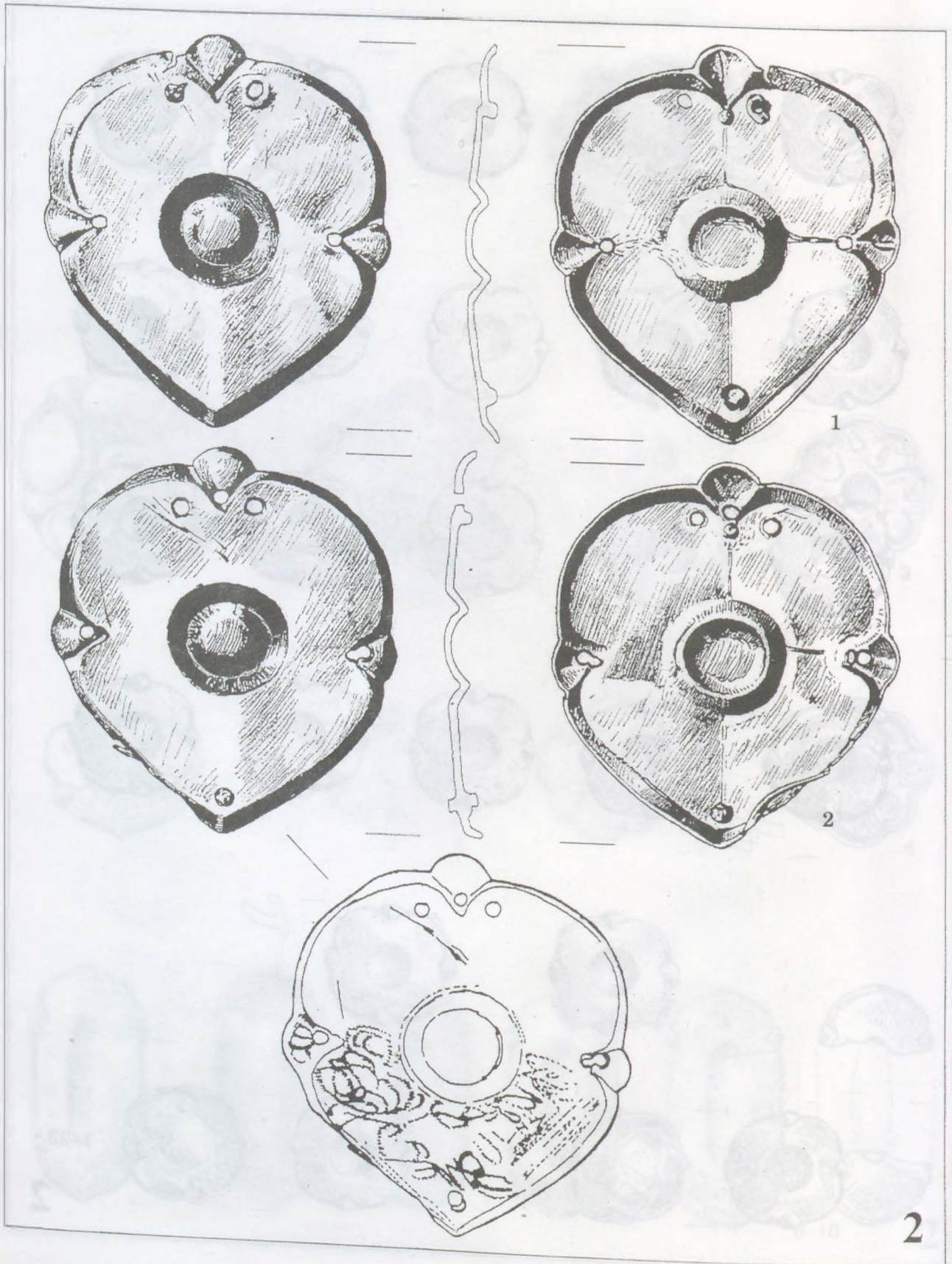

358. tábla: Sárrétudvari-Poroshalom. 2. sír (1:1)

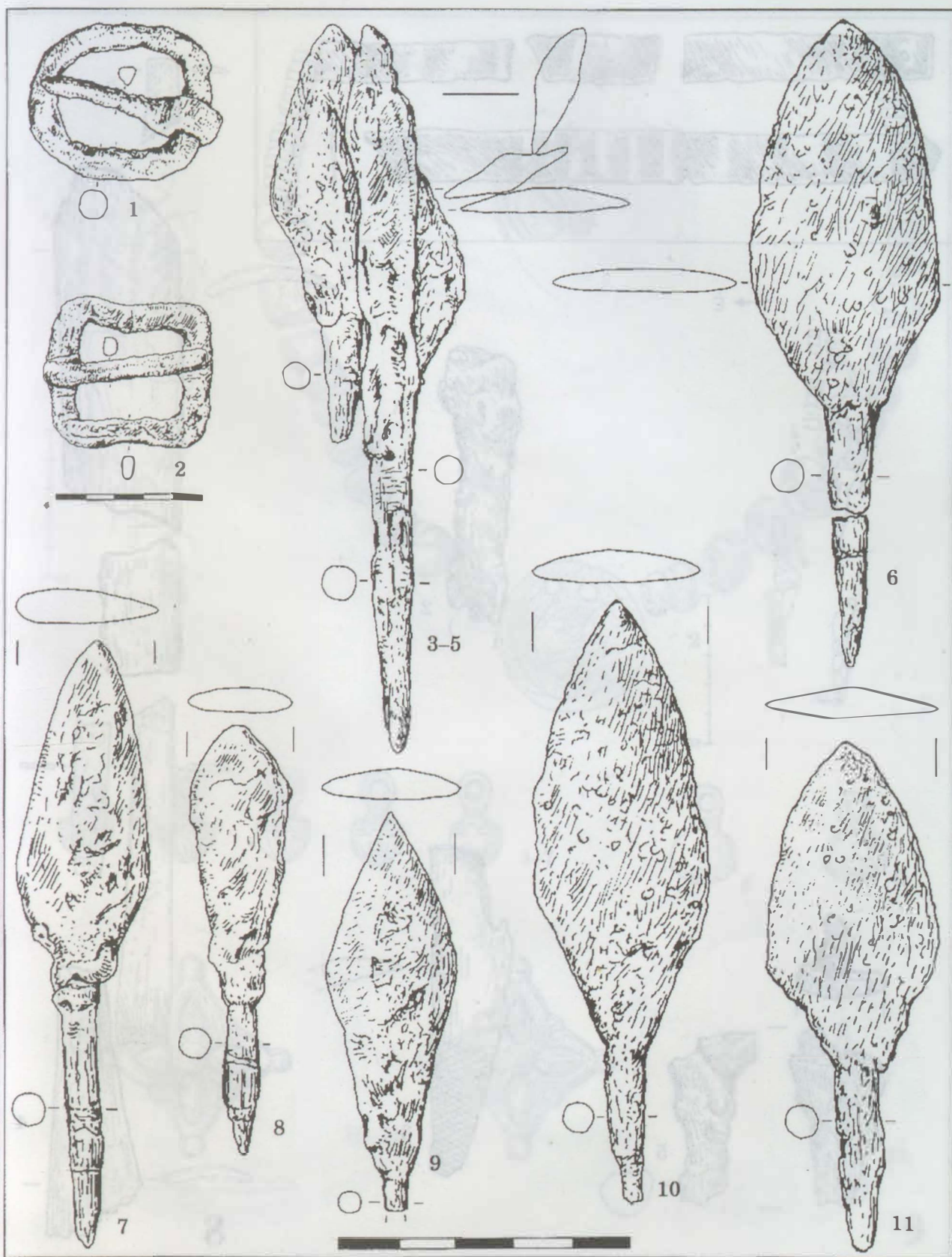

359. tábla: Sárrétudvari-Poroshalom. 2. sír (1:1)

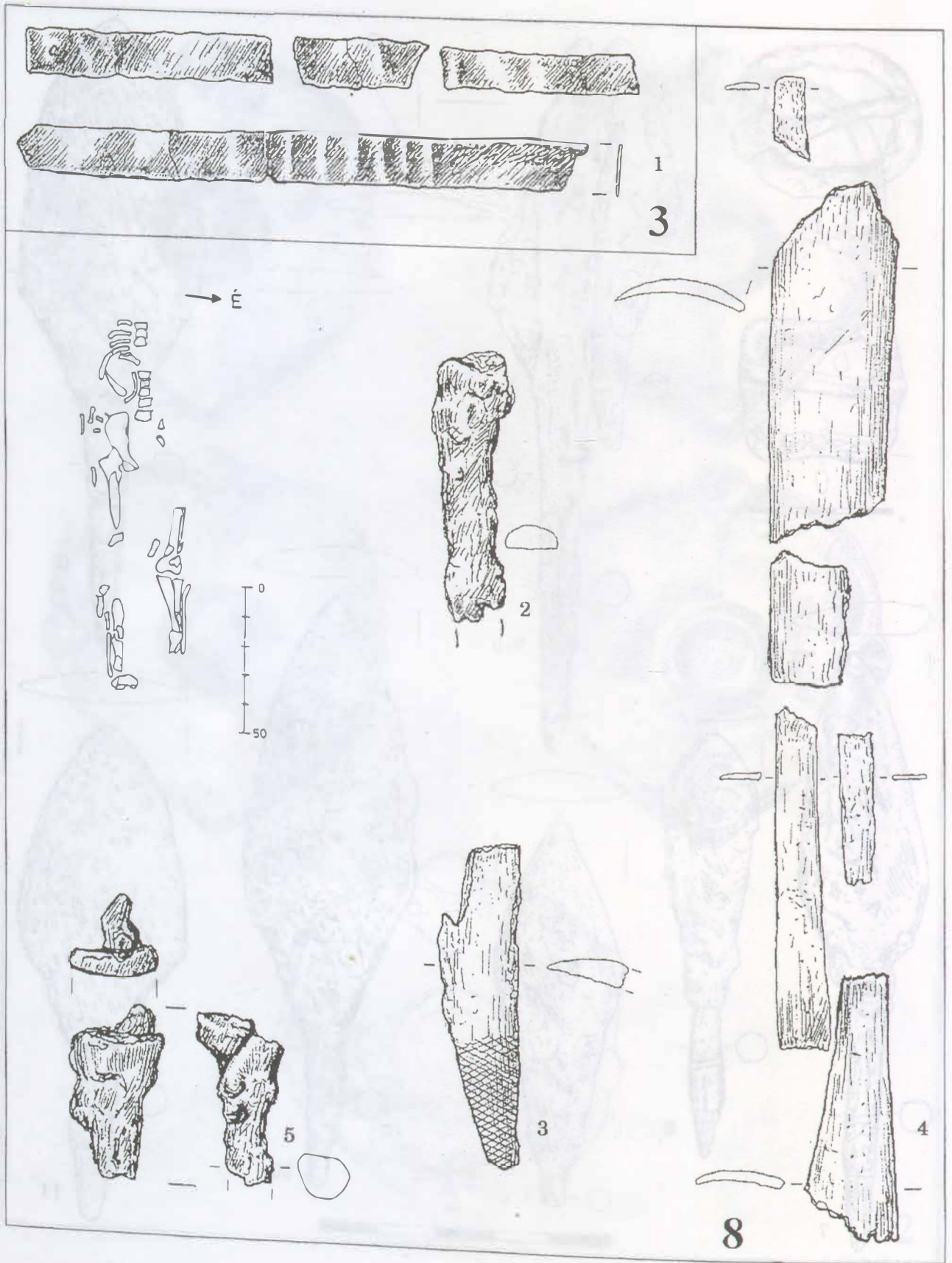

360. tábla: Sárretudvari-Poroshalom. 3., 8. sír (1:1)



361. tábla: Sárrétudvari-Poroshalom. 9. sír (1:1)

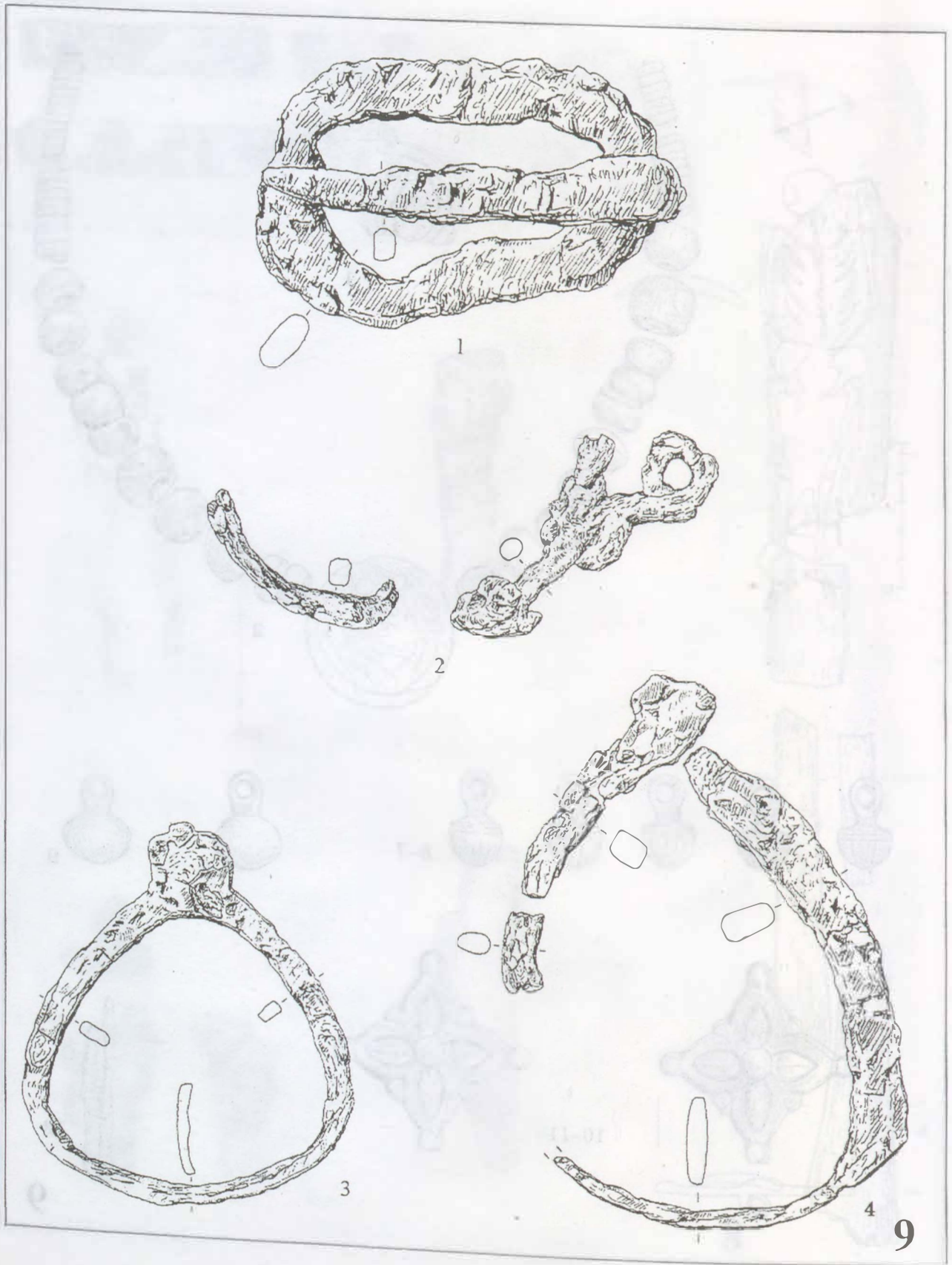

362. tábla: Sárrétudvari-Poroshalom. 9. sír (1. 1:1; 2-3. 1:2)

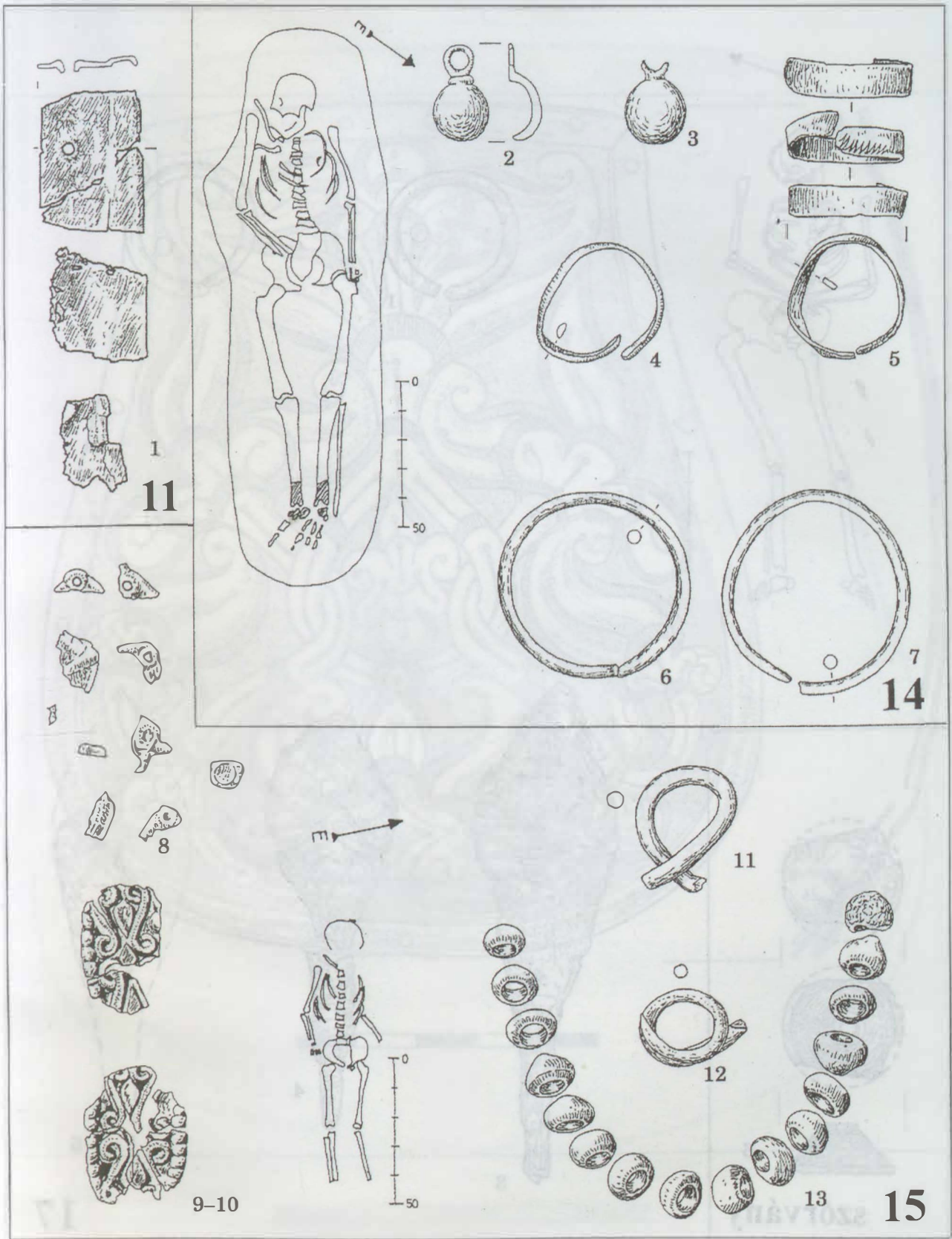

363. tábla: Sárretudvari-Poroshalom. 11., 14-15. sír (1:1)

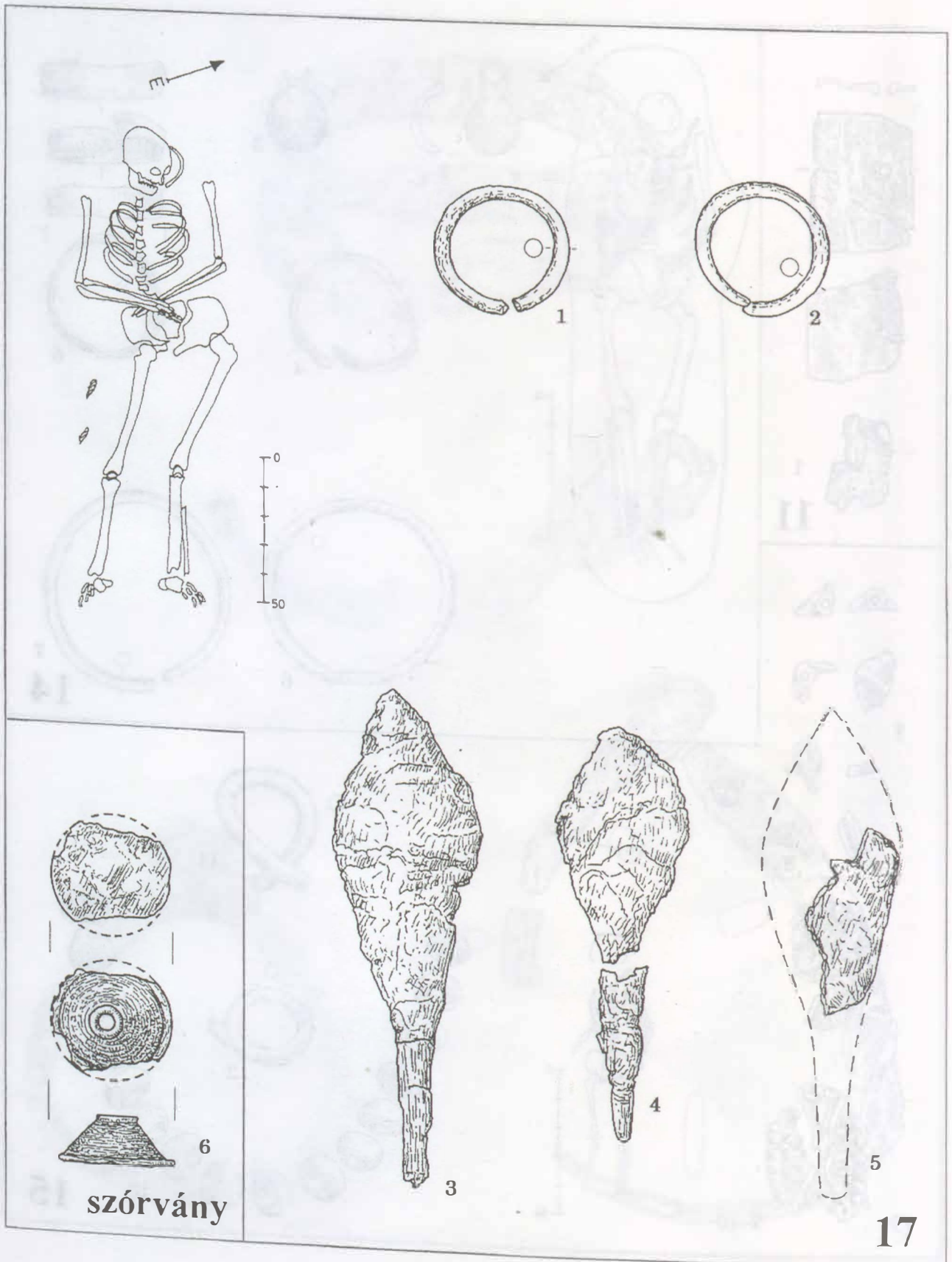

szórvány

17

364. tábla: Sárrétudvari-Poroshalom. 17. sír és szórvány (1:1)

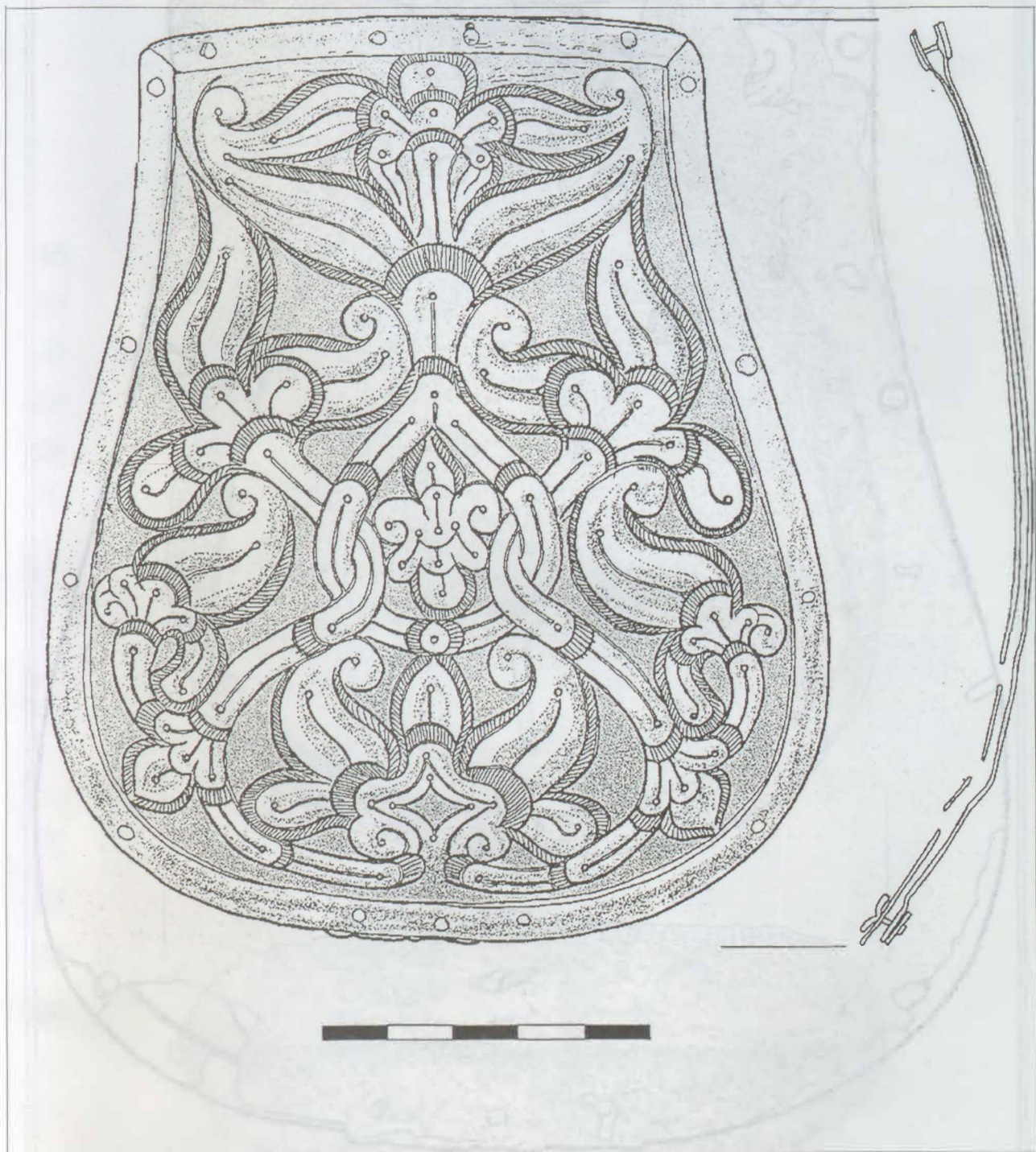

365. tábla: Ismeretlen lelőhely (Báránd-Belterület) (1:1)

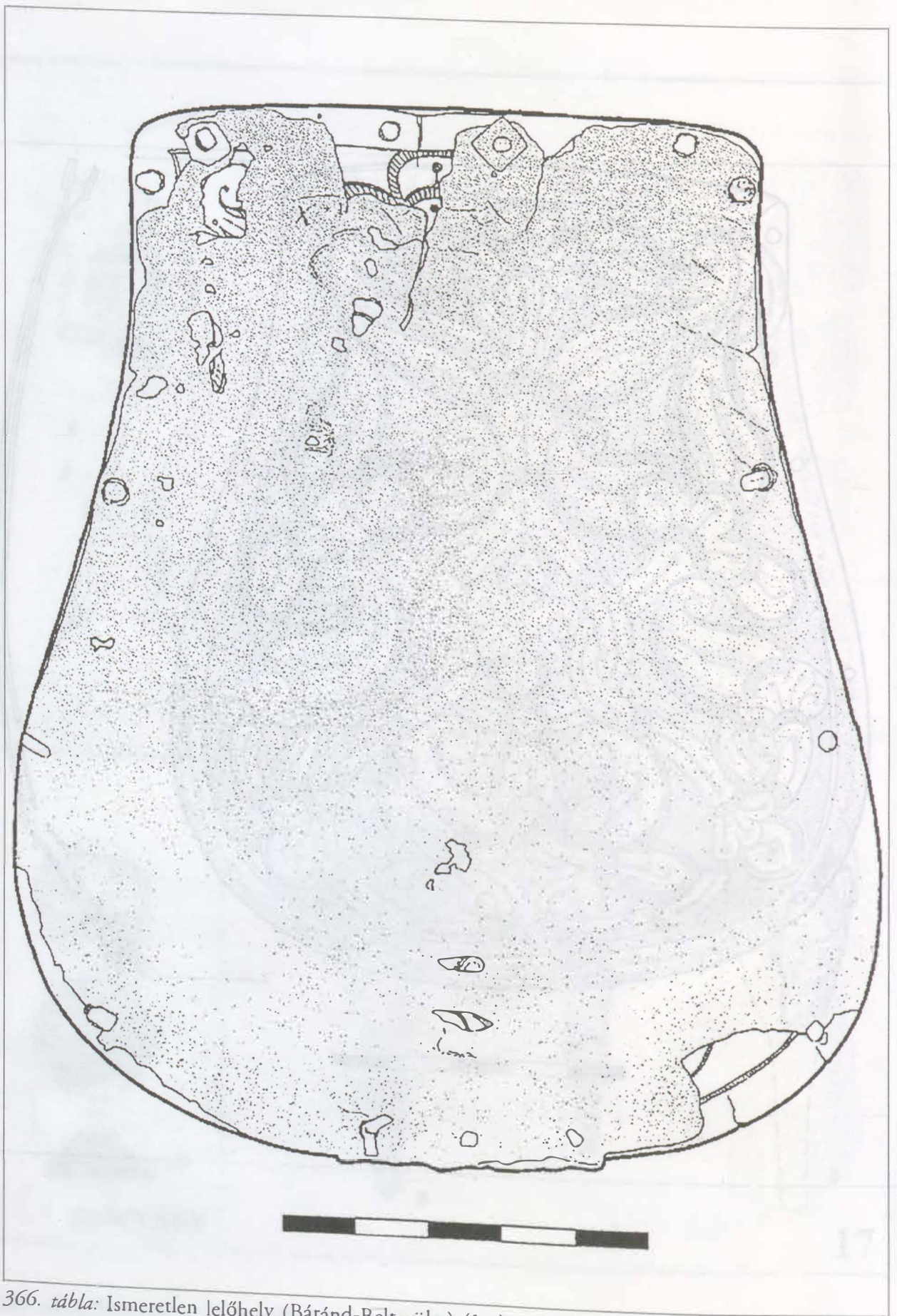

366. tábla: Ismeretlen lelőhely (Báránd-Belterület) (1:1)

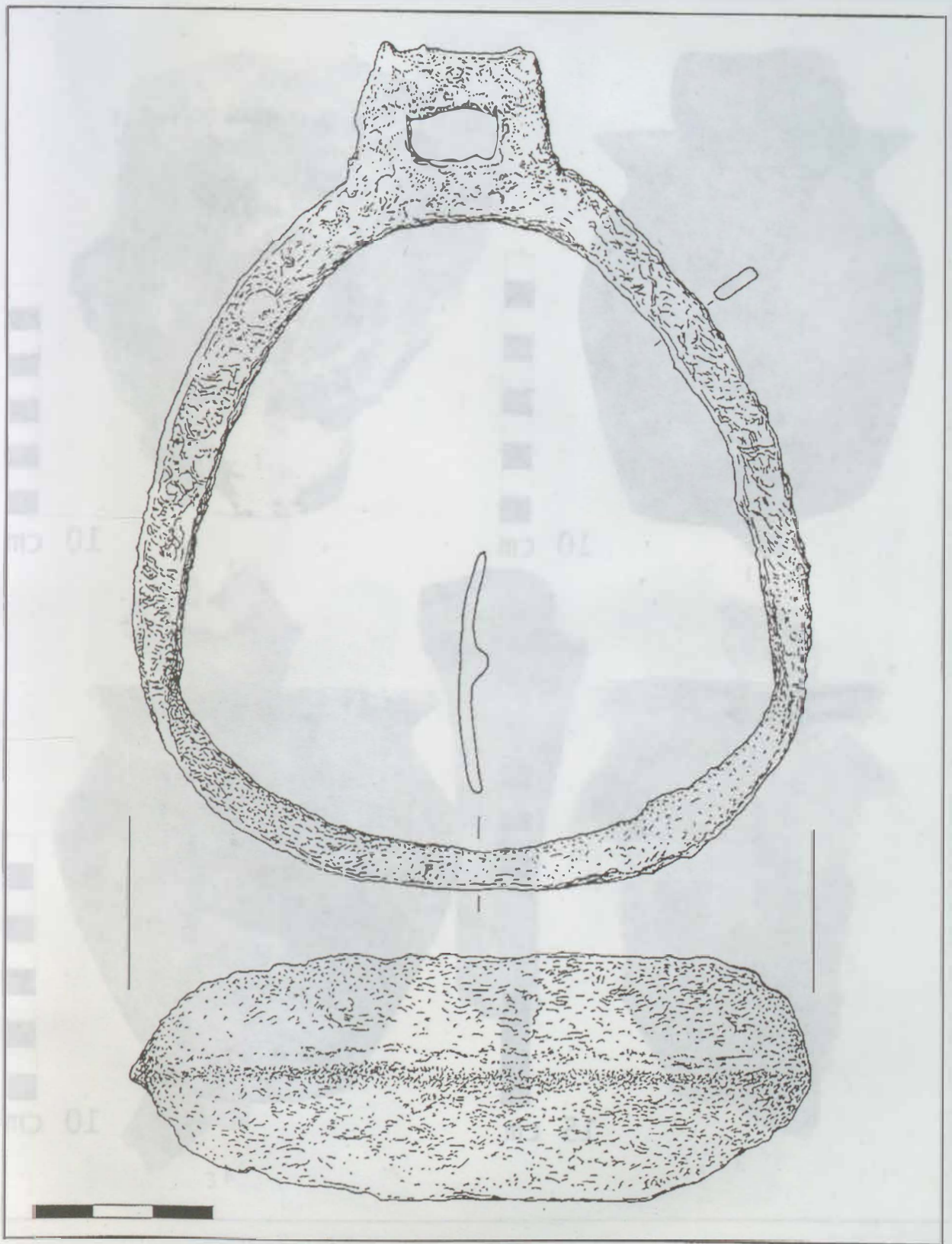

367. tábla: Ismeretlen lelőhely (Báránd-Belterület) (1:1)

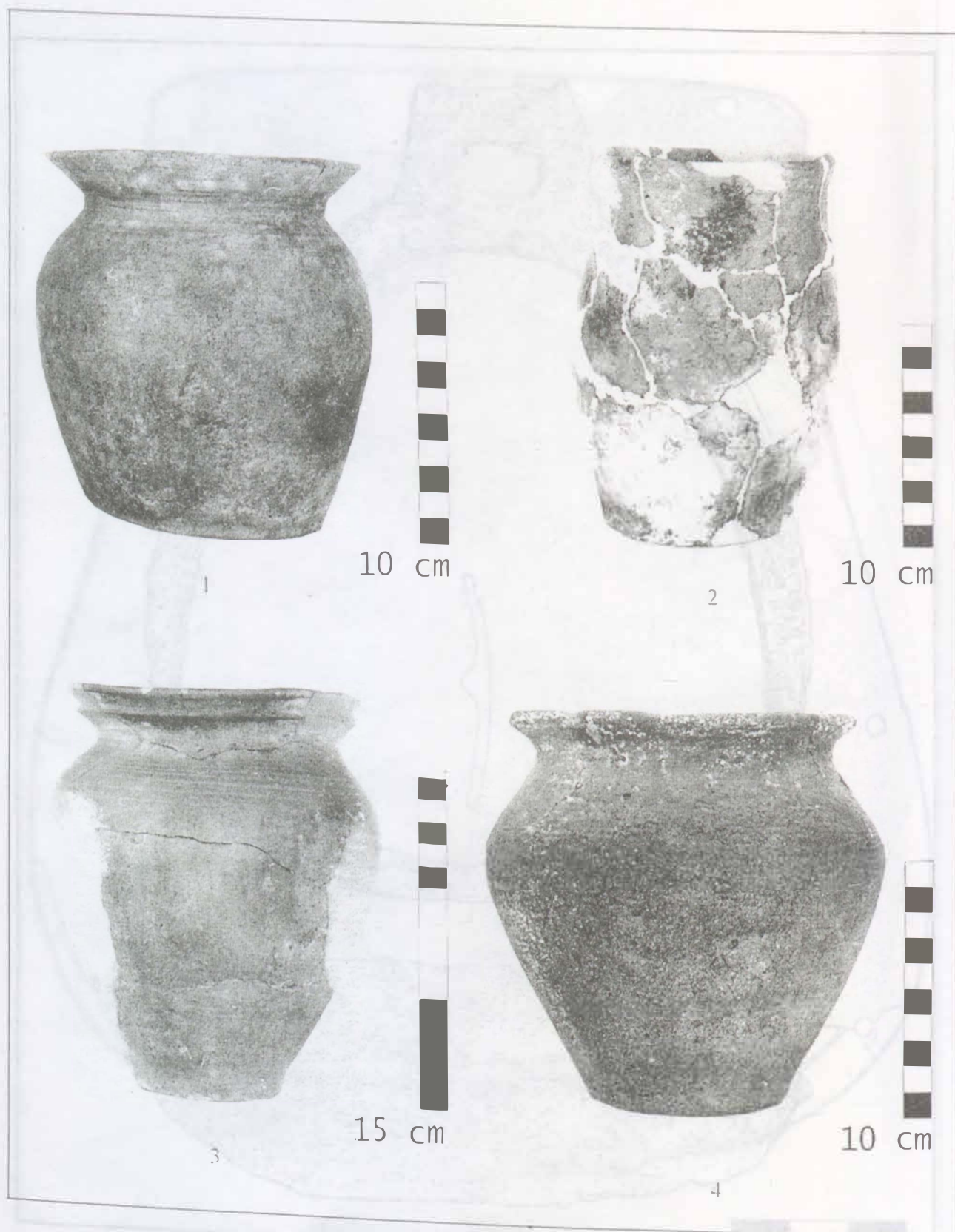

368. tábla: 1. Debrecen-Józsa, Clara Zetkin utca 23. sír; 2. Hajdúszoboszló-Árkoshalom. 189. sír; 3. Püspökladány-Eperjesvölgy. Szórvány; 4. Körösszegapáti-Pállapály. 27. sír



369. tábla: Hajdúszoboszló-Árkoshalom. 1. 64. sír; 2. 110. sír; 3. 117. sír; 4. 121. sír; 5. 185. sír



370. tábla: Hajdúszoboszló-Árkoshalom. 1. 261. sír; 2. 187. sír; 3. 213. sír; 4. 217. sír



371. tábla: Püspökladány-Eperjesvölgy. 1. 195. sír; 2. 216. sír; 3. 231. sír; 4. 195. sír; 5. 280. sír; 6. 185. sír



372. tábla: Sárrétudvari-Hízóföld. 1. 258. sír; 2., 4. 206. sír; 3. 259. sír; 5. 119. sír; 6. 138. sír; 7. 92. sír; 8. 28. sír



373. tábla: Sárrétudvari-Hízóföld. 130. sír



374. tábla: Sárrétudvari-Hízóföld. 160. sír



375. tábla: 1. Hajdúböszörmény-Bodaszőlő, Büdöskút 2. sír; 2–3. Sárrétudvari-Poroshalom. 2., 7. sír; 4–5. Sárrétudvari-Hízófld. 54. sír

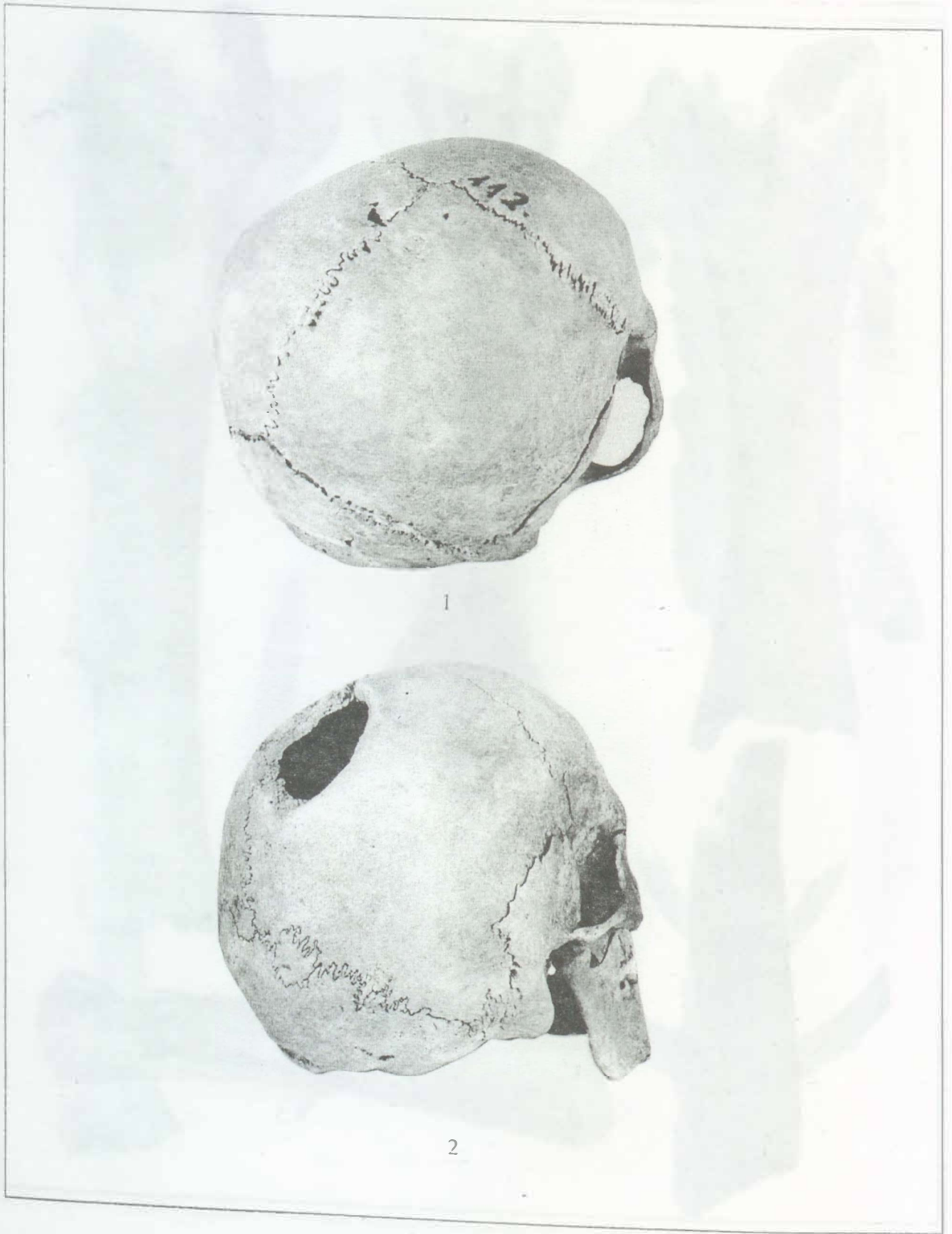

376. tábla: 1. Sárrétudvari-Hízóföld. 112. sír; 2. Berekböszörmény-Református templom

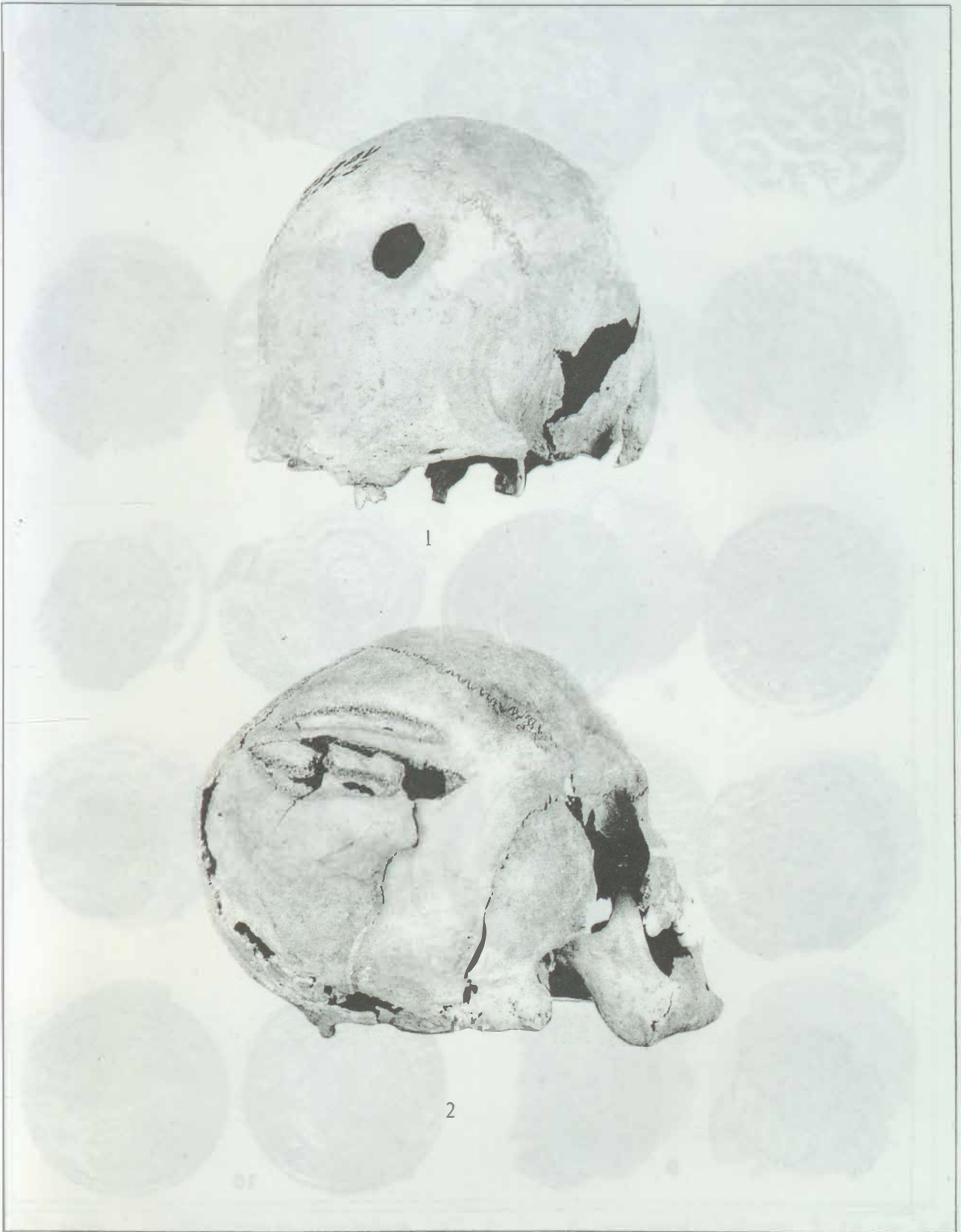

377. tábla: 1. Sárrétudvari-Hízóföld. 179. sír; 2. Sárrétudvari-Poroshalom. 1. sír

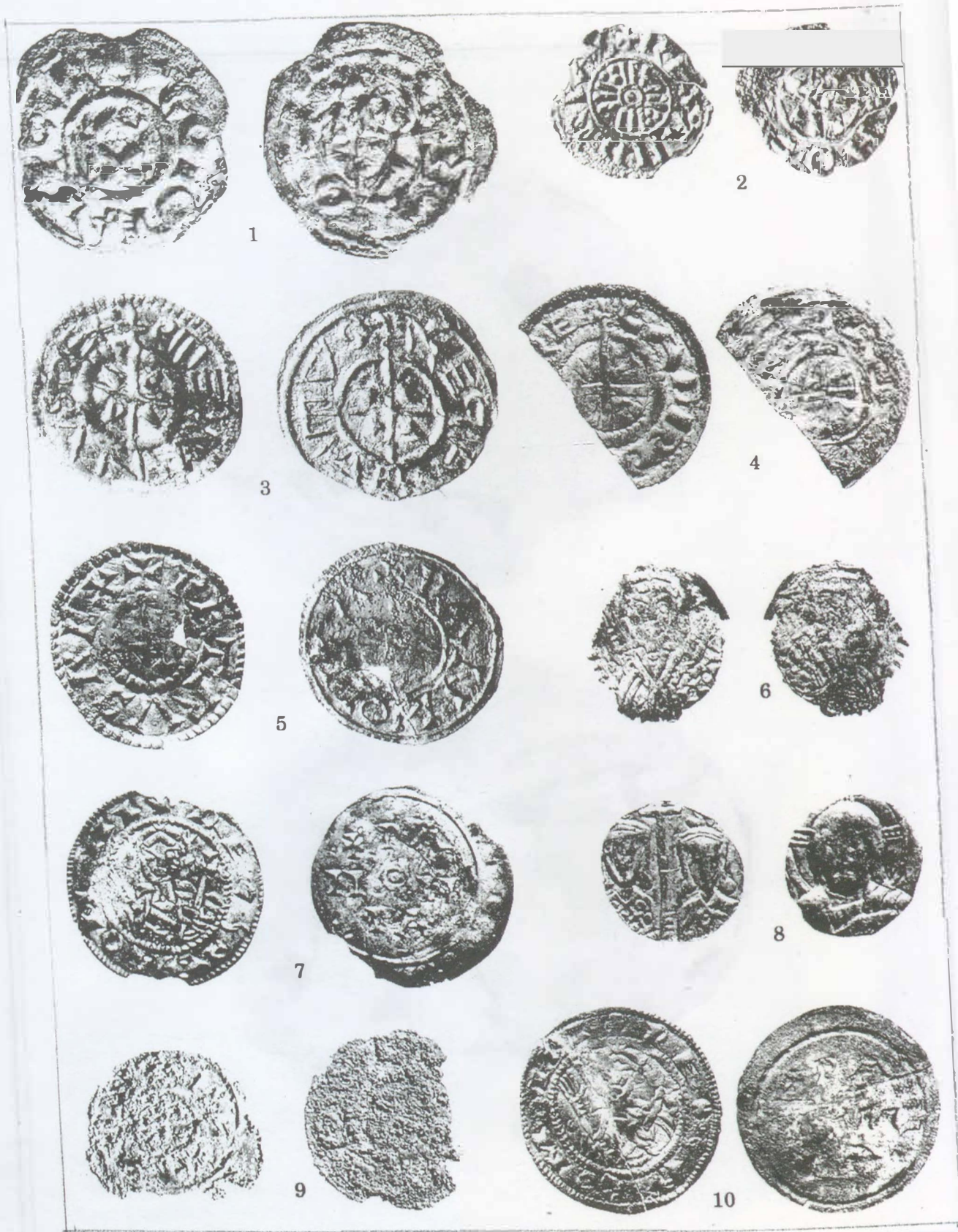

378. tábla: 1. Biharkeresztes, Bethlen Gábor u. 25. 1. sír; 2–10. Hajdúszoboszló-Árkoshalom, 2. 19 sír; 3. 22. sír; 4. 38. sír; 5. 47. sír; 6. 57. sír; 7. 73. sír; 8. 109. sír; 9. 143. sír; 10. 153. sír (2:1)

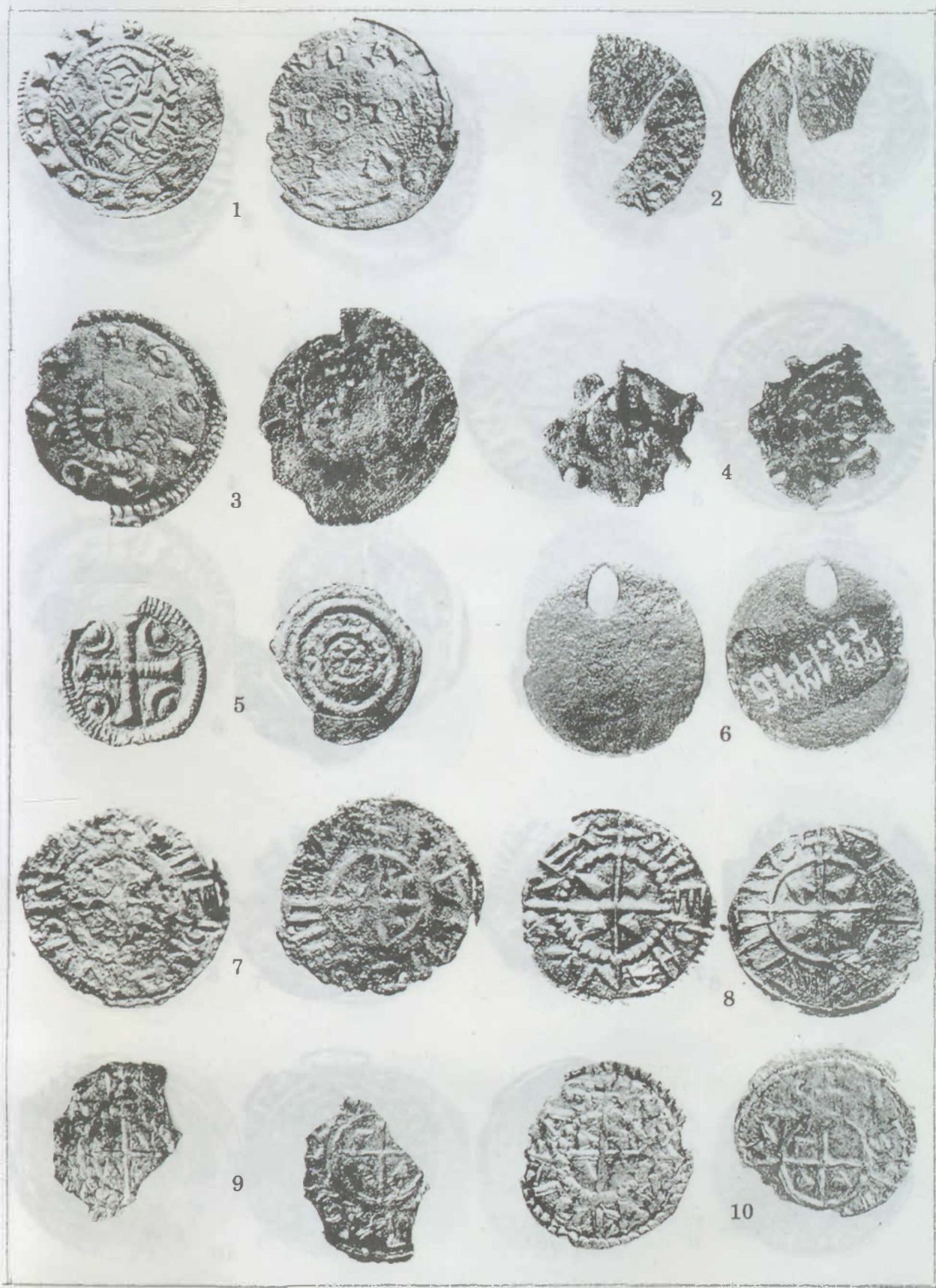

379. tábla: 1. Hajdúszoboszló-Árkoshalom. 247. sír; 2–4. Körösszegapáti-Pállapály. 2. 18. sír; 3–4. 24. sír; 5. Nagyrábé-Des Echerolles-dűlő; 6–10. Püspökladány-Eperjesvölgy. 6. 23. sír; 7. 73. sír; 8. 107. sír; 9–10. 160. sír (2:1)



380. tábla: Püspökladány-Eperjesvölgy. 1. 218. sír; 2. 220. sír; 3. 234. sír; 4. 235. sír; 5. 238. sír; 6. 264. sír; 7-8. 271. sír; 9. 274. sír; 10. 284. sír (2:1)



381. tábla: Püspökladány-Eperjesvölgy. 1. 309. sír; 2. 324. sír; 3. 328. sír; 4. 329. sír; 5. 330. sír; 6. 332. sír; 7. 337. sír; 8. 349. sír; 9. 355. sír; 10. 362. sír (2:1)

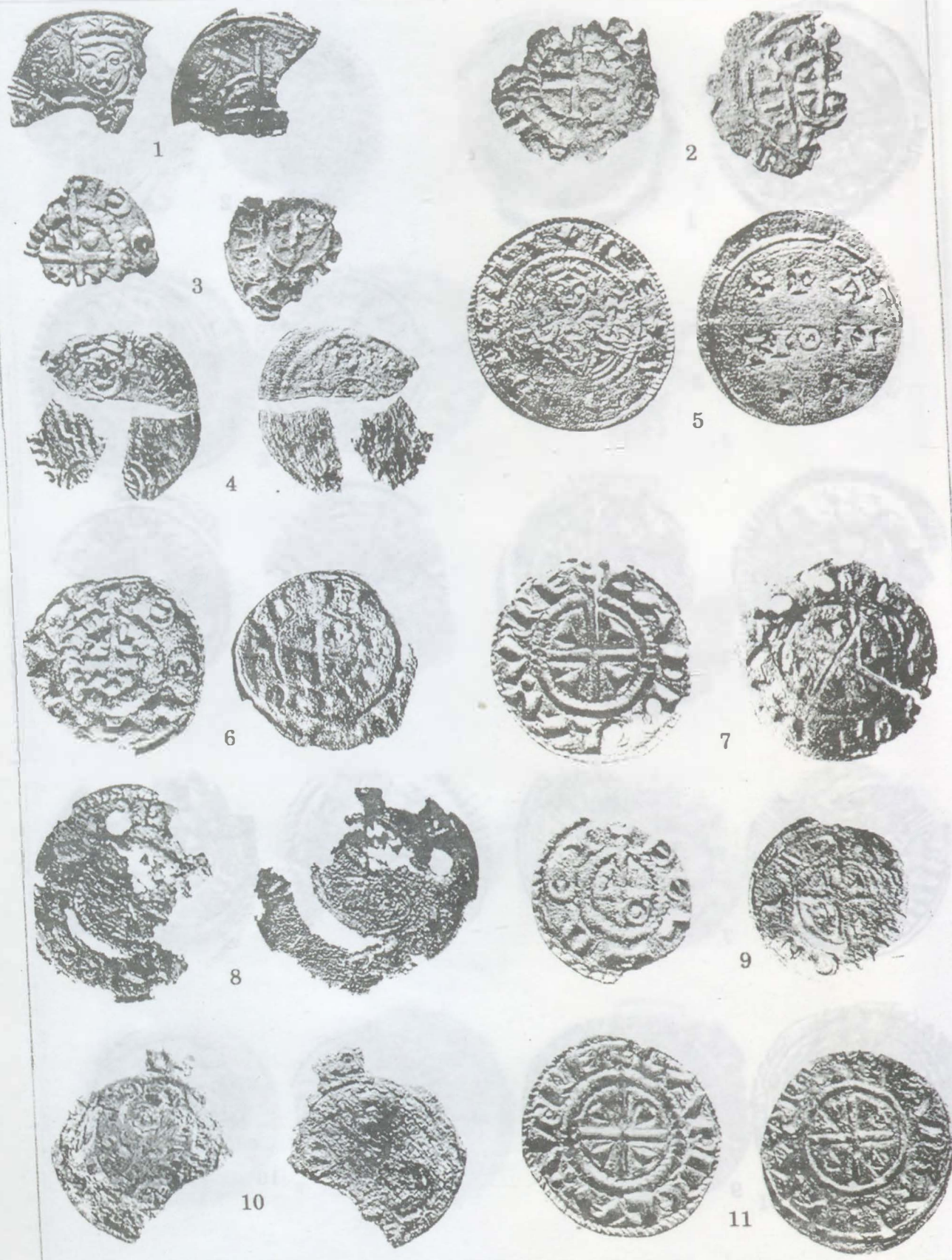

382. tábla: Püspökladány-Eperjesvölgy. 1. 375. sír; 2-3. 376. sír; 4. 384. sír; 5. 391. sír; 6. 397. sír; 7-8. 409. sír; 9. 418. sír; 10. 427. sír; 11. 430. sír (2:1)

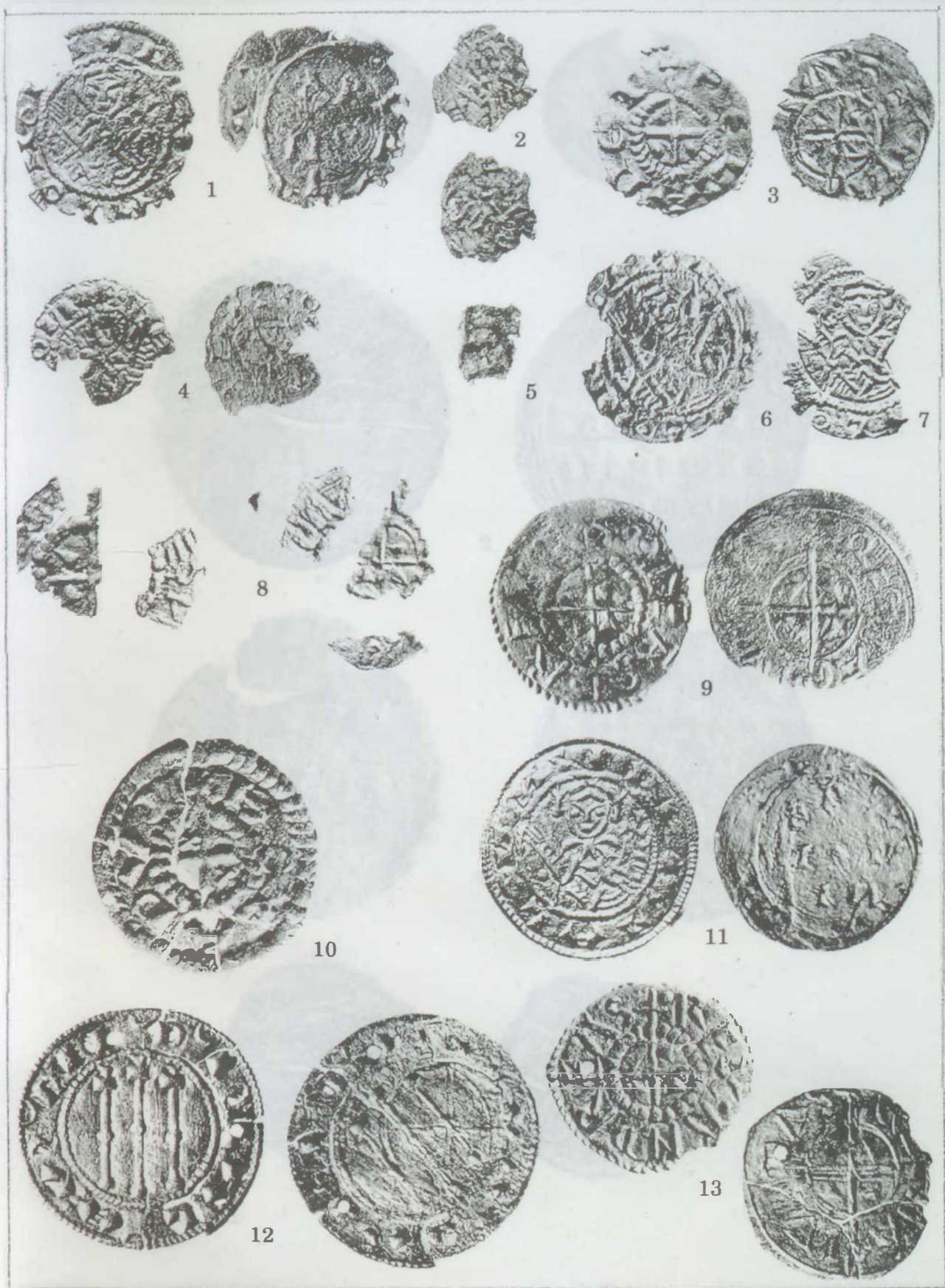

383. tábla: Püspökladány-Eperjesvölgy. 1. 486. sír; 2. 492. sír; 3. 493. sír; 4. 496. sír; 5. 542. sír; 6. 558. sír; 7. 575. sír; 8. 563. sír; 9. 574. sír; 10. 576. sír; 11. 582. sír; 12. 600. sír; 13. szórványlelet (2:1)

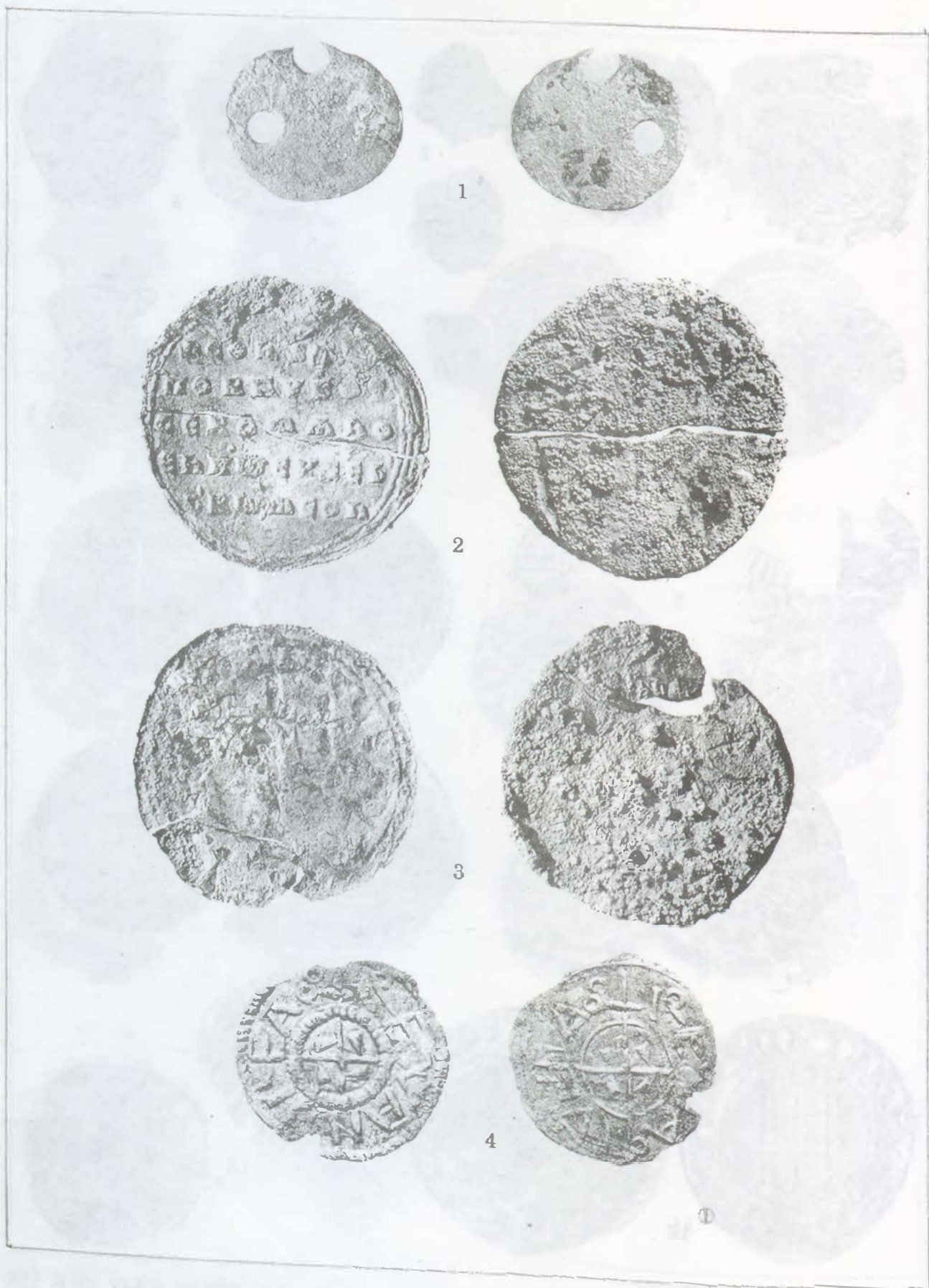

384. tábla: Sárrétudvari-Hízóföld. 1. 110. sír; 2–3. 112. sír; 4. szórványelet (2:1)



